

## 2.85 TO 12 VOLT FIXED POSITIVE LOCAL VOLTAGE REGULATOR

ISSUE 3 - DECEMBER 2001

## ZR78L SERIES

### DEVICE DESCRIPTION

The ZR78L Series three terminal fixed positive voltage regulators feature internal circuit current limit and thermal shutdown making the devices difficult to destroy. The circuit design allows creation of any custom voltage in the range 2.85 to 12 volts. The devices are available in a small outline surface mount package, ideal for applications where space saving is important, as well as through hole TO92 style packaging. The devices are suited to local voltage regulation applications, where problems could be encountered with distributed single source regulation, as well as more general voltage regulation applications.

The ZR78L Series show performance characteristics superior to other local voltage regulators. The initial output voltage is maintained to within 2.5% with a quiescent current of typically 350 $\mu$ A. Output voltage change, with input voltage and load current, is much lower than competitive devices. The ZR78L devices are completely stable with no external components. The device will shut down under thermal overload conditions but as the device cools, regulation will restart.

### FEATURES

- Small outline SOT223 package
- SO8 package (3.3V and 5.0V)
- TO92 package
- 2.85 to 12 Volt
- Output current up to 200mA
- Tight initial tolerance
- Low quiescent current
- -55 to 125°C temperature range
- No external components
- Internal thermal shutdown
- Internal short circuit current limit

### VOLTAGE RANGE

ZR78L028	2.85V
ZR78L03	3.0V
ZR78L033	3.3V
ZR78L04	4.0V
ZR78L048	4.85V
ZR78L05	5.0V
ZR78L052	5.2V
ZR78L057	5.7V
ZR78L06	6.0V
ZR78L07	7.0V
ZR78L08	8.0V
ZR78L085	8.5V
ZR78L09	9.0V
ZR78L10	10.0V
ZR78L12	12.0V

# ZR78L SERIES

## ABSOLUTE MAXIMUM RATING

Input voltage	20V
Output Current(I <sub>o</sub> )	200mA
Operating Temperature	-55 to 125°C
Storage Temperature	-65 to 150°C

<b>Power Dissipation (T<sub>amb</sub>=25°C)</b>	
SOT223	2W(Note 3)
TO92	600mW
S08	780mW(Note 3)

## ELECTRICAL CHARACTERISTICS:

### Notes:

1. The maximum operating input voltage and output current of the device will be governed by the maximum power dissipation of the selected package. Maximum package power dissipation is specified at 25 °C and must be linearly derated to zero at T<sub>amb</sub>=125°C.
2. The following data represents pulse test conditions with junction temperatures as indicated at the initiation of the test. Continuous operation of the devices with the stated conditions might exceed the power dissipation limits of the chosen package.

3. Maximum power dissipation, for the SOT223 and SO8 packages, is calculated assuming that the device is mounted on a PCB measuring 2 inches square.
4. The shut down feature of the device operates if its temperature exceeds its design limit as might occur during external faults, short circuits etc. If the regulator is supplied from an inductive source then a large voltage transient, on the regulator input, can result should the shut down circuit operate. It is advised that a capacitor (1μF or greater) should be applied across the regulator input to ensure that the maximum voltage rating of the device is not exceeded under shutdown conditions.

## ZR78L028 TEST CONDITIONS (Unless otherwise stated): T<sub>j</sub>=25°C, I<sub>O</sub>=100mA, V<sub>in</sub>=6.85V

SYMBOL	PARAMETER	CONDITIONS	MIN.	TYP.	MAX.	UNITS
V <sub>O</sub>	Output Voltage		2.78	2.85	2.92	V
		I <sub>O</sub> =1 to 200mA τ	2.736		2.964	V
		V <sub>in</sub> =4.85 to 20V I <sub>O</sub> =1 to 100mA τ	2.736		2.964	V
ΔV <sub>O</sub>	Line Regulation	V <sub>in</sub> =4.85 to 20V		10	40	mV
ΔV <sub>O</sub>	Load Regulation	I <sub>O</sub> =1 to 200mA		5	25	mV
		I <sub>O</sub> =1 to 100mA		2		mV
I <sub>q</sub>	Quiescent Current	τ		350	600	μA
ΔI <sub>q</sub>	Quiescent Current Change	I <sub>O</sub> =1 to 200mA V <sub>in</sub> =4.85 to 20V			100 100	μA μA
V <sub>n</sub>	Output Noise Voltage	f=10Hz to 10kHz		75		μV rms
ΔV <sub>in</sub> /ΔV <sub>O</sub>	Ripple Rejection	V <sub>in</sub> =5.85 to 18V f=120Hz	48	62		dB
V <sub>in</sub>	Input Voltage Required To Maintain Regulation		4.85	4.55		V
ΔV <sub>O</sub> /ΔT	Average Temperature Coefficient of V <sub>O</sub>	I <sub>O</sub> =5.0mA τ		0.1		mV/°C

τ=T<sub>j</sub>=-55 to 125°C

## ZR78L SERIES

### ZR78L03 TEST CONDITIONS (Unless otherwise stated): $T_j=25^{\circ}\text{C}$ , $I_O=100\text{mA}$ , $V_{in}=7\text{V}$

SYMBOL	PARAMETER	CONDITIONS	MIN.	TYP.	MAX.	UNITS
$V_O$	Output Voltage		2.92	3.0	3.08	V
		$I_O=1$ to 200mA $\tau$	2.88		3.12	V
		$V_{in}=5$ to 20V $I_O=1$ to 100mA $\tau$	2.88		3.12	V
$\Delta V_O$	Line Regulation	$V_{in}=5$ to 20V		10	40	mV
$\Delta V_O$	Load Regulation	$I_O=1$ to 200mA		5	25	mV
		$I_O=1$ to 100mA		2		mV
$I_q$	Quiescent Current	$\tau$		350	600	$\mu\text{A}$
$\Delta I_q$	Quiescent Current Change	$I_O=1$ to 200mA			100	$\mu\text{A}$
		$V_{in}=5$ to 20V			100	$\mu\text{A}$
$V_n$	Output Noise Voltage	$f=10\text{Hz}$ to 10kHz		75		$\mu\text{V rms}$
$\Delta V_{in}/\Delta V_O$	Ripple Rejection	$V_{in}=6$ to 18V $f=120\text{Hz}$	48	62		dB
$V_{in}$	Input Voltage Required To Maintain Regulation		5	4.7		V
$\Delta V_O/\Delta T$	Average Temperature Coefficient of $V_O$	$I_O=5.0\text{mA}$ $\tau$		0.1		mV/ $^{\circ}\text{C}$

### ZR78L033 TEST CONDITIONS (Unless otherwise stated): $T_j=25^{\circ}\text{C}$ , $I_O=100\text{mA}$ , $V_{in}=7.3\text{V}$

SYMBOL	PARAMETER	CONDITIONS	MIN.	TYP.	MAX.	UNITS
$V_O$	Output Voltage		3.218	3.3	3.382	V
		$I_O=1$ to 200mA $\tau$	3.168		3.432	V
		$V_{in}=5.3$ to 20V $I_O=1$ to 100mA $\tau$	3.168		3.432	V
$\Delta V_O$	Line Regulation	$V_{in}=5.3$ to 20V		7.5	30	mV
$\Delta V_O$	Load Regulation	$I_O=1$ to 200mA		5	25	mV
		$I_O=1$ to 100mA		2		mV
$I_q$	Quiescent Current	$\tau$		350	600	$\mu\text{A}$
$\Delta I_q$	Quiescent Current Change	$I_O=1$ to 200mA			100	$\mu\text{A}$
		$V_{in}=5.3$ to 20V			100	$\mu\text{A}$
$V_n$	Output Noise Voltage	$f=10\text{Hz}$ to 10kHz		50		$\mu\text{V rms}$
$\Delta V_{in}/\Delta V_O$	Ripple Rejection	$V_{in}=6.3$ to 18V $f=120\text{Hz}$	50	64		dB
$V_{in}$	Input Voltage Required To Maintain Regulation		5.3	5		V
$\Delta V_O/\Delta T$	Average Temperature Coefficient of $V_O$	$I_O=5.0\text{mA}$ $\tau$		0.1		mV/ $^{\circ}\text{C}$

$\tau = T_j = -55$  to  $125^{\circ}\text{C}$

## ZR78L SERIES

### ZR78L04 TEST CONDITIONS (Unless otherwise stated): $T_j=25^{\circ}\text{C}$ , $I_O=100\text{mA}$ , $V_{in}=8\text{V}$

SYMBOL	PARAMETER	CONDITIONS	MIN.	TYP.	MAX.	UNITS
$V_O$	Output Voltage		3.9	4.0	4.1	V
		$I_O=1$ to 200mA $\tau$	3.84		4.16	V
		$V_{in}=6$ to 20V $I_O=1$ to 100mA $\tau$	3.84		4.16	V
$\Delta V_O$	Line Regulation	$V_{in}=6$ to 20V		10	40	mV
$\Delta V_O$	Load Regulation	$I_O=1$ to 200mA		5	25	mV
		$I_O=1$ to 100mA		2		mV
$I_q$	Quiescent Current	$\tau$		350	600	$\mu\text{A}$
$\Delta I_q$	Quiescent Current Change	$I_O=1$ to 200mA			100	$\mu\text{A}$
		$V_{in}=6$ to 20V			100	$\mu\text{A}$
$V_n$	Output Noise Voltage	$f=10\text{Hz}$ to 10kHz		75		$\mu\text{V rms}$
$\Delta V_{in}/\Delta V_O$	Ripple Rejection	$V_{in}=7$ to 18V $f=120\text{Hz}$	48	62		dB
$V_{in}$	Input Voltage Required To Maintain Regulation		6	5.3		V
$\Delta V_O/\Delta T$	Average Temperature Coefficient of $V_O$	$I_O=5.0\text{mA}$ $\tau$		0.1		$\text{mV}/^{\circ}\text{C}$

### ZR78L048 TEST CONDITIONS (Unless otherwise stated): $T_j=25^{\circ}\text{C}$ , $I_O=100\text{mA}$ , $V_{in}=8.85\text{V}$

SYMBOL	PARAMETER	CONDITIONS	MIN.	TYP.	MAX.	UNITS
$V_O$	Output Voltage		4.729	4.85	4.971	V
		$I_O=1$ to 200mA $\tau$	4.656		5.044	V
		$V_{in}=6.8$ to 20V $I_O=1$ to 100mA $\tau$	4.656		5.044	V
$\Delta V_O$	Line Regulation	$V_{in}=6.85$ to 20V		10	40	mV
$\Delta V_O$	Load Regulation	$I_O=1$ to 200mA		5	25	mV
		$I_O=1$ to 100mA		2		mV
$I_q$	Quiescent Current	$\tau$		350	600	$\mu\text{A}$
$\Delta I_q$	Quiescent Current Change	$I_O=1$ to 200mA			100	$\mu\text{A}$
		$V_{in}=6.85$ to 20V			100	$\mu\text{A}$
$V_n$	Output Noise Voltage	$f=10\text{Hz}$ to 10kHz		50		$\mu\text{V rms}$
$\Delta V_{in}/\Delta V_O$	Ripple Rejection	$V_{in}=7.85$ to 18V $f=120\text{Hz}$	50	64		dB
$V_{in}$	Input Voltage Required To Maintain Regulation		6.85	6.55		V
$\Delta V_O/\Delta T$	Average Temperature Coefficient of $V_O$	$I_O=5.0\text{mA}$ $\tau$		0.1		$\text{mV}/^{\circ}\text{C}$

$\tau = T_j = -55$  to  $125^{\circ}\text{C}$

## ZR78L SERIES

### ZR78L10 TEST CONDITIONS (Unless otherwise stated): $T_j=25^{\circ}\text{C}$ , $I_O=100\text{mA}$ , $V_{in}=14\text{V}$

SYMBOL	PARAMETER	CONDITIONS	MIN.	TYP.	MAX.	UNITS
$V_O$	Output Voltage		9.75	10	10.25	V
		$I_O=1$ to 200mA $\tau$	9.6		10.4	V
		$V_{in}=12$ to 20V $I_O=1$ to 100mA $\tau$	9.6		10.4	V
$\Delta V_O$	Line Regulation	$V_{in}=12$ to 20V		12	40	mV
$\Delta V_O$	Load Regulation	$I_O=1$ to 200mA $I_O=1$ to 100mA		9	30	mV
				3		mV
$I_q$	Quiescent Current	$\tau$		350	600	$\mu\text{A}$
$\Delta I_q$	Quiescent Current Change	$I_O=1$ to 200mA $V_{in}=12$ to 20V			100	$\mu\text{A}$
					100	$\mu\text{A}$
$V_n$	Output Noise Voltage	$f=10\text{Hz}$ to 10kHz		150		$\mu\text{V rms}$
$\Delta V_{in}/\Delta V_O$	Ripple Rejection	$V_{in}=13$ to 18V $f=120\text{Hz}$	43	57		dB
$V_{in}$	Input Voltage Required To Maintain Regulation		12	11.7		V
$\Delta V_O/\Delta T$	Average Temperature Coefficient of $V_O$	$I_O=5.0\text{mA}$ $\tau$		0.25		$\text{mV}/^{\circ}\text{C}$

### ZR78L12 TEST CONDITIONS (Unless otherwise stated): $T_j=25^{\circ}\text{C}$ , $I_O=100\text{mA}$ , $V_{in}=16\text{V}$

SYMBOL	PARAMETER	CONDITIONS	MIN.	TYP.	MAX.	UNITS
$V_O$	Output Voltage		11.7	12	12.3	V
		$I_O=1$ to 200mA $\tau$	11.52		12.48	V
		$V_{in}=14$ to 20V $I_O=1$ to 100mA $\tau$	11.52		12.48	V
$\Delta V_O$	Line Regulation	$V_{in}=14$ to 20V		12	40	mV
$\Delta V_O$	Load Regulation	$I_O=1$ to 200mA $I_O=1$ to 100mA		9	30	mV
				3		mV
$I_q$	Quiescent Current	$\tau$		350	600	$\mu\text{A}$
$\Delta I_q$	Quiescent Current Change	$I_O=1$ to 200mA $V_{in}=14$ to 20V			100	$\mu\text{A}$
					100	$\mu\text{A}$
$V_n$	Output Noise Voltage	$f=10\text{Hz}$ to 10kHz		150		$\mu\text{V rms}$
$\Delta V_{in}/\Delta V_O$	Ripple Rejection	$V_{in}=15$ to 18V $f=120\text{Hz}$	43	57		dB
$V_{in}$	Input Voltage Required To Maintain Regulation		14	13.7		V
$\Delta V_O/\Delta T$	Average Temperature Coefficient of $V_O$	$I_O=5.0\text{mA}$ $\tau$		0.25		$\text{mV}/^{\circ}\text{C}$

$\tau = T_j = -55$  to  $125^{\circ}\text{C}$

ZR78L028 ZR78L03  
 ZR78L04 ZR78L057  
 ZR78L09

**ZR78L  
 SERIES**

**TYPICAL CHARACTERISTICS**

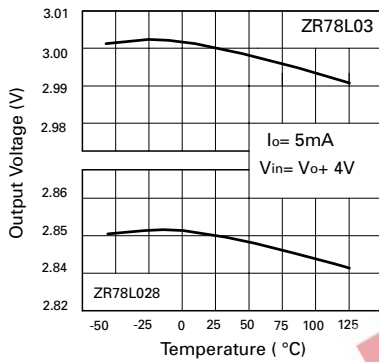

**Output Voltage Temperature Coefficient**

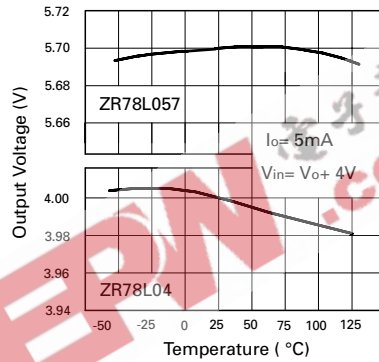

**Output Voltage Temperature Coefficient**

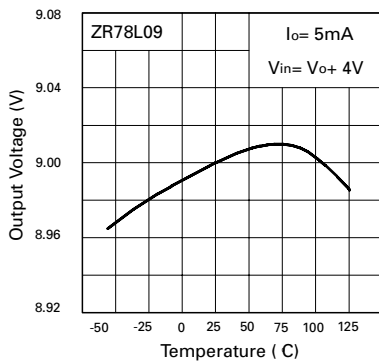

**Output Voltage Temperature Coefficient**

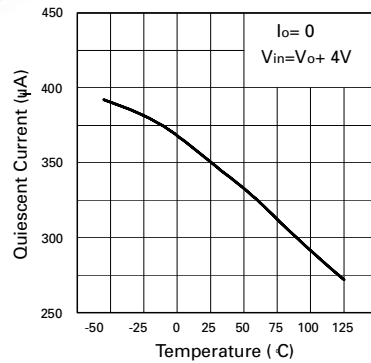

**Quiescent Current vs. Temperature**

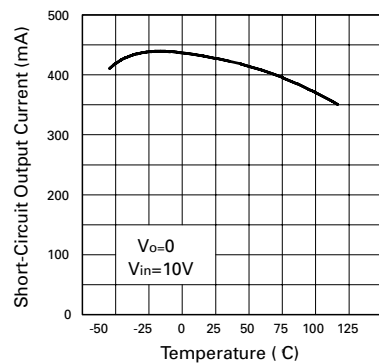

**Peak Output Current vs. Temperature**

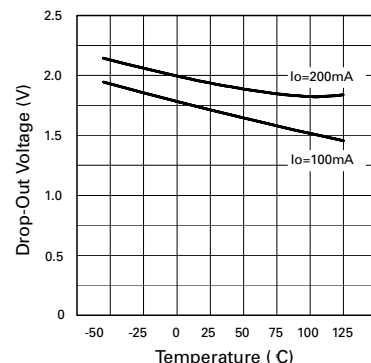

**Drop-Out Voltage vs. Temperature**

ZR78L033 ZR78L05  
 ZR78L06 ZR78L08  
 ZR78L10

**ZR78L  
 SERIES**

**TYPICAL CHARACTERISTICS**

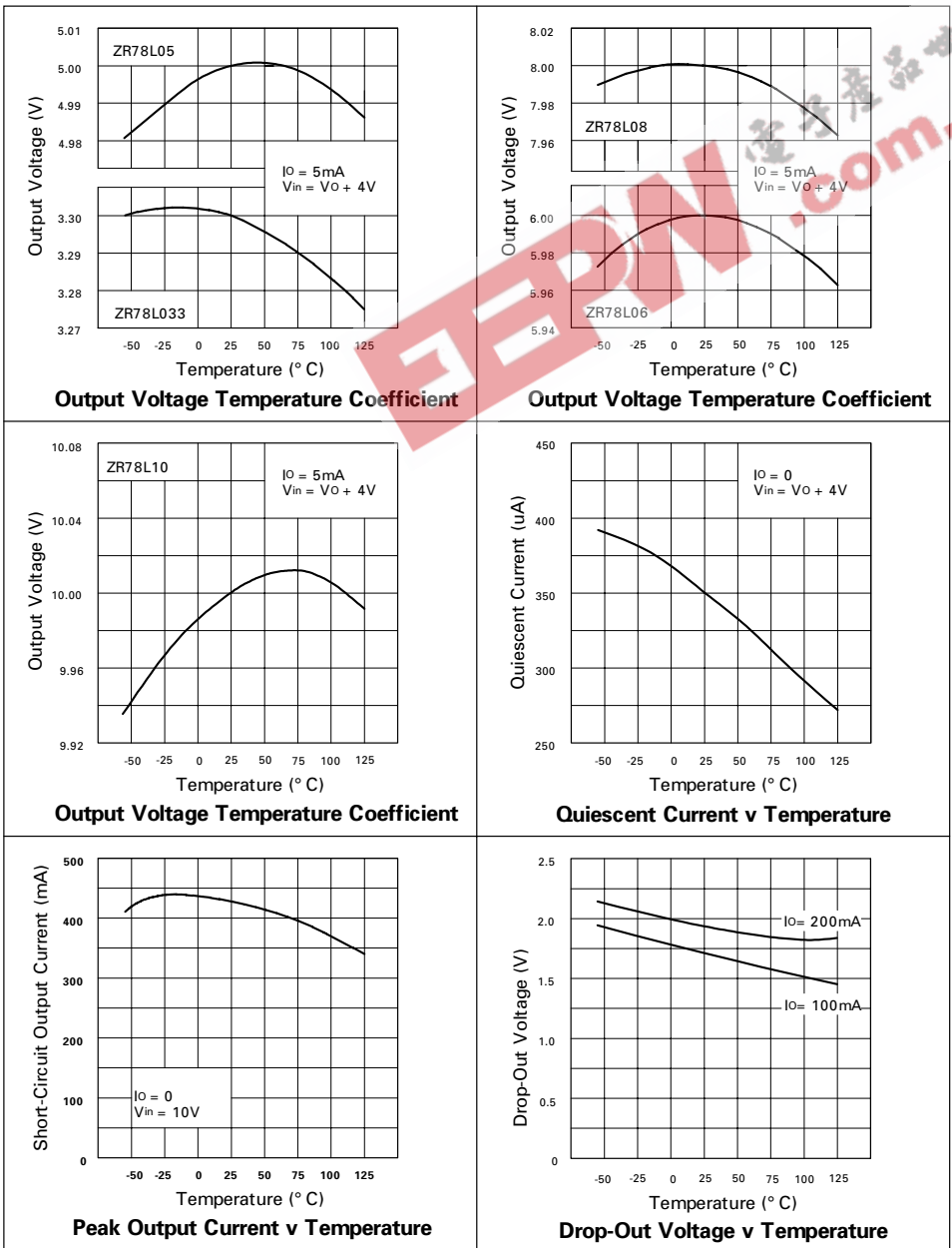

## ZR78L SERIES

### ZR78L057 TEST CONDITIONS (Unless otherwise stated): $T_j=25^{\circ}\text{C}$ , $I_O=100\text{mA}$ , $V_{in}=9.7\text{V}$

SYMBOL	PARAMETER	CONDITIONS	MIN.	Typ.	MAX.	UNITS
$V_O$	Output Voltage		5.557	5.7	5.843	V
		$I_O=1$ to 200mA $\tau$	5.47		5.93	V
		$V_{in}=7.7$ to 20V $I_O=1$ to 100mA $\tau$	5.47		5.93	V
$\Delta V_O$	Line Regulation	$V_{in}=7.7$ to 20V		10	40	mV
$\Delta V_O$	Load Regulation	$I_O=1$ to 200mA $I_O=1$ to 100mA		7 2.5	30	mV mV
$I_q$	Quiescent Current	$\tau$		350	600	$\mu\text{A}$
$\Delta I_q$	Quiescent Current Change	$I_O=1$ to 200mA $V_{in}=7.7$ to 20V			100 100	$\mu\text{A}$ $\mu\text{A}$
$V_n$	Output Noise Voltage	$f=10\text{Hz}$ to 10kHz		90		$\mu\text{V rms}$
$\Delta V_{in}/\Delta V_O$	Ripple Rejection	$V_{in}=8.7$ to 18V $f=120\text{Hz}$	48	62		dB
$V_{in}$	Input Voltage Required To Maintain Regulation		7.7	7.4		V
$\Delta V_O/\Delta T$	Average Temperature Coefficient of $V_O$	$I_O=5.0\text{mA}$ $\tau$		0.15		$\text{mV}/^{\circ}\text{C}$

### ZR78L06 TEST CONDITIONS (Unless otherwise stated): $T_j=25^{\circ}\text{C}$ , $I_O=100\text{mA}$ , $V_{in}=10\text{V}$

SYMBOL	PARAMETER	CONDITIONS	MIN.	TYP.	MAX.	UNITS
$V_O$	Output Voltage		5.85	6	6.15	V
		$I_O=1$ to 200mA $\tau$	5.76		6.24	V
		$V_{in}=8$ to 20V $I_O=1$ to 100mA $\tau$	5.76		6.24	V
$\Delta V_O$	Line Regulation	$V_{in}=8$ to 20V		10	40	mV
$\Delta V_O$	Load Regulation	$I_O=1$ to 200mA $I_O=1$ to 100mA		7 2.5	30	mV mV
$I_q$	Quiescent Current	$\tau$		350	600	$\mu\text{A}$
$\Delta I_q$	Quiescent Current Change	$I_O=1$ to 200mA $V_{in}=8$ to 20V			100 100	$\mu\text{A}$ $\mu\text{A}$
$V_n$	Output Noise Voltage	$f=10\text{Hz}$ to 10kHz		90		$\mu\text{V rms}$
$\Delta V_{in}/\Delta V_O$	Ripple Rejection	$V_{in}=9$ to 18V $f=120\text{Hz}$	48	62		dB
$V_{in}$	Input Voltage Required To Maintain Regulation		8	7.7		V
$\Delta V_O/\Delta T$	Average Temperature Coefficient of $V_O$	$I_O=5.0\text{mA}$ $\tau$		0.15		$\text{mV}/^{\circ}\text{C}$

$\tau = T_j = -55$  to  $125^{\circ}\text{C}$



## ZR78L SERIES

### ZR78L05 TEST CONDITIONS (Unless otherwise stated): $T_j=25^{\circ}\text{C}$ , $I_O=100\text{mA}$ , $V_{in}=9\text{V}$

SYMBOL	PARAMETER	CONDITIONS	MIN.	TYP.	MAX.	UNITS
$V_O$	Output Voltage		4.875	5	5.125	V
		$I_O=1$ to 200mA $\tau$	4.8		5.2	V
		$V_{in}=7$ to 20V $I_O=1$ to 100mA $\tau$	4.8		5.2	V
$\Delta V_O$	Line Regulation	$V_{in}=7$ to 20V		10	40	mV
$\Delta V_O$	Load Regulation	$I_O=1$ to 200mA		5	25	mV
		$I_O=1$ to 100mA		2		mV
$I_q$	Quiescent Current	$\tau$		350	600	$\mu\text{A}$
$\Delta I_q$	Quiescent Current Change	$I_O=1$ to 200mA			100	$\mu\text{A}$
		$V_{in}=7$ to 20V			100	$\mu\text{A}$
$V_n$	Output Noise Voltage	$f=10\text{Hz}$ to 10kHz		75		$\mu\text{V rms}$
$\Delta V_{in}/\Delta V_O$	Ripple Rejection	$V_{in}=8$ to 18V $f=120\text{Hz}$	48	62		dB
$V_{in}$	Input Voltage Required To Maintain Regulation		7	6.7		V
$\Delta V_O/\Delta T$	Average Temperature Coefficient of $V_O$	$I_O=5.0\text{mA}$ $\tau$		0.1		mV/ $^{\circ}\text{C}$

### ZR78L052 TEST CONDITIONS (Unless otherwise stated): $T_j=25^{\circ}\text{C}$ , $I_O=100\text{mA}$ , $V_{in}=9.2\text{V}$

SYMBOL	PARAMETER	CONDITIONS	MIN.	TYP.	MAX.	UNITS
$V_O$	Output Voltage		5.070	5.2	5.330	V
		$I_O=1$ to 200mA $\tau$	4.99		5.41	V
		$V_{in}=7.2$ to 20V $I_O=1$ to 100mA $\tau$	4.99		5.41	V
$\Delta V_O$	Line Regulation	$V_{in}=7.2$ to 20V		10	40	mV
$\Delta V_O$	Load Regulation	$I_O=1$ to 200mA		5	25	mV
		$I_O=1$ to 100mA		2		mV
$I_q$	Quiescent Current	$\tau$		350	600	$\mu\text{A}$
$\Delta I_q$	Quiescent Current Change	$I_O=1$ to 200mA			100	$\mu\text{A}$
		$V_{in}=7.2$ to 20V			100	$\mu\text{A}$
$V_n$	Output Noise Voltage	$f=10\text{Hz}$ to 10kHz		75		$\mu\text{V rms}$
$\Delta V_{in}/\Delta V_O$	Ripple Rejection	$V_{in}=8.2$ to 18V $f=120\text{Hz}$	48	62		dB
$V_{in}$	Input Voltage Required To Maintain Regulation		7.2	6.9		V
$\Delta V_O/\Delta T$	Average Temperature Coefficient of $V_O$	$I_O=5.0\text{mA}$ $\tau$		0.1		mV/ $^{\circ}\text{C}$

$\tau = T_j = -55$  to  $125^{\circ}\text{C}$

## ZR78L SERIES

**ZR78L085 TEST CONDITIONS (Unless otherwise stated):**  $T_j=25^{\circ}\text{C}$ ,  $I_O=100\text{mA}$ ,  $V_{in}=12.5\text{V}$

SYMBOL	PARAMETER	CONDITIONS	MIN.	TYP.	MAX.	UNITS
$V_O$	Output Voltage		8.288	8.5	8.712	V
		$I_O=1$ to 200mA $\tau$	8.16		8.84	V
		$V_{in}=10$ to 20V $I_O=1$ to 100mA $\tau$	8.16		8.84	V
$\Delta V_O$	Line Regulation	$V_{in}=10.5$ to 20V		11	40	mV
$\Delta V_O$	Load Regulation	$I_O=1$ to 200mA		8	30	mV
		$I_O=1$ to 100mA		3		mV
$I_q$	Quiescent Current	$\tau$		350	600	$\mu\text{A}$
$\Delta I_q$	Quiescent Current Change	$I_O=1$ to 200mA			100	$\mu\text{A}$
		$V_{in}=10.5$ to 20V			100	$\mu\text{A}$
$V_n$	Output Noise Voltage	$f=10\text{Hz}$ to 10kHz		115		$\mu\text{V rms}$
$\Delta V_{in}/\Delta V_O$	Ripple Rejection	$V_{in}=11.5$ to 18V $f=120\text{Hz}$	44	60		dB
$V_{in}$	Input Voltage Required To Maintain Regulation		10.5	10.2		V
$\Delta V_O/\Delta T$	Average Temperature Coefficient of $V_O$	$I_O=5.0\text{mA}$ $\tau$		0.25		$\text{mV}/^{\circ}\text{C}$

**ZR78L09 TEST CONDITIONS (Unless otherwise stated):**  $T_j=25^{\circ}\text{C}$ ,  $I_O=100\text{mA}$ ,  $V_{in}=13\text{V}$

SYMBOL	PARAMETER	CONDITIONS	MIN.	TYP.	MAX.	UNITS
$V_O$	Output Voltage		8.775	9.0	9.225	V
		$I_O=1$ to 200mA $\tau$	8.64		9.36	V
		$V_{in}=11$ to 20V $I_O=1$ to 100mA $\tau$	8.64		9.36	V
$\Delta V_O$	Line Regulation	$V_{in}=11$ to 20V		12	40	mV
$\Delta V_O$	Load Regulation	$I_O=1$ to 200mA		9	30	mV
		$I_O=1$ to 100mA		3		mV
$I_q$	Quiescent Current	$\tau$		350	600	$\mu\text{A}$
$\Delta I_q$	Quiescent Current Change	$I_O=1$ to 200mA			100	$\mu\text{A}$
		$V_{in}=11$ to 20V			100	$\mu\text{A}$
$V_n$	Output Noise Voltage	$f=10\text{Hz}$ to 10kHz		150		$\mu\text{V rms}$
$\Delta V_{in}/\Delta V_O$	Ripple Rejection	$V_{in}=12$ to 18V $f=120\text{Hz}$	43	57		dB
$V_{in}$	Input Voltage Required To Maintain Regulation		11	10.7		V
$\Delta V_O/\Delta T$	Average Temperature Coefficient of $V_O$	$I_O=5.0\text{mA}$ $\tau$		0.25		$\text{mV}/^{\circ}\text{C}$

$\tau = T_j = -55$  to  $125^{\circ}\text{C}$

# ZR78L SERIES

ZR78L028 ZR78L03  
ZR78L04 ZR78L057  
ZR78L09

## TYPICAL CHARACTERISTICS

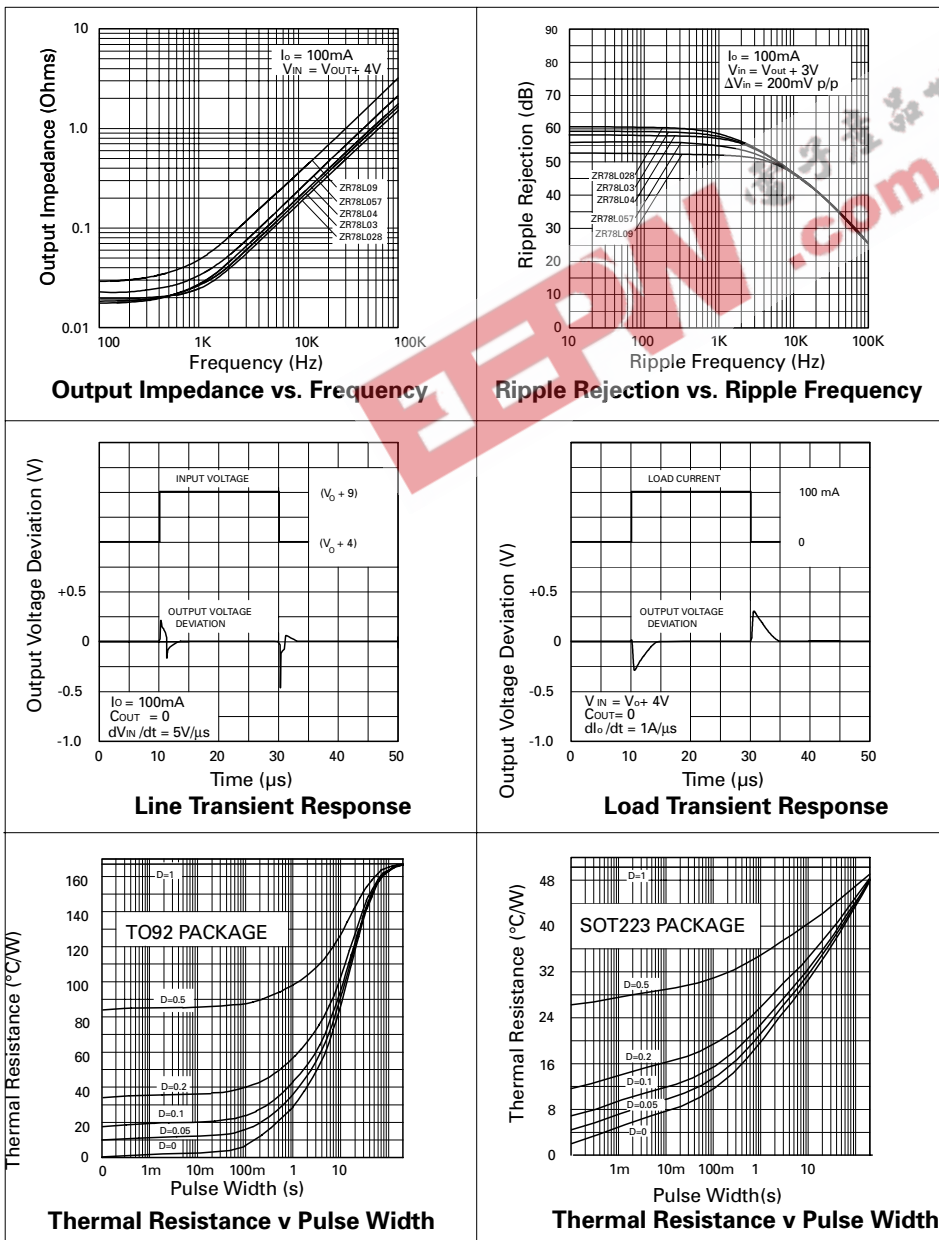

# ZR78L SERIES

ZR78L033 ZR78L05  
 ZR78L06 ZR78L08  
 ZR78L10

## TYPICAL CHARACTERISTICS

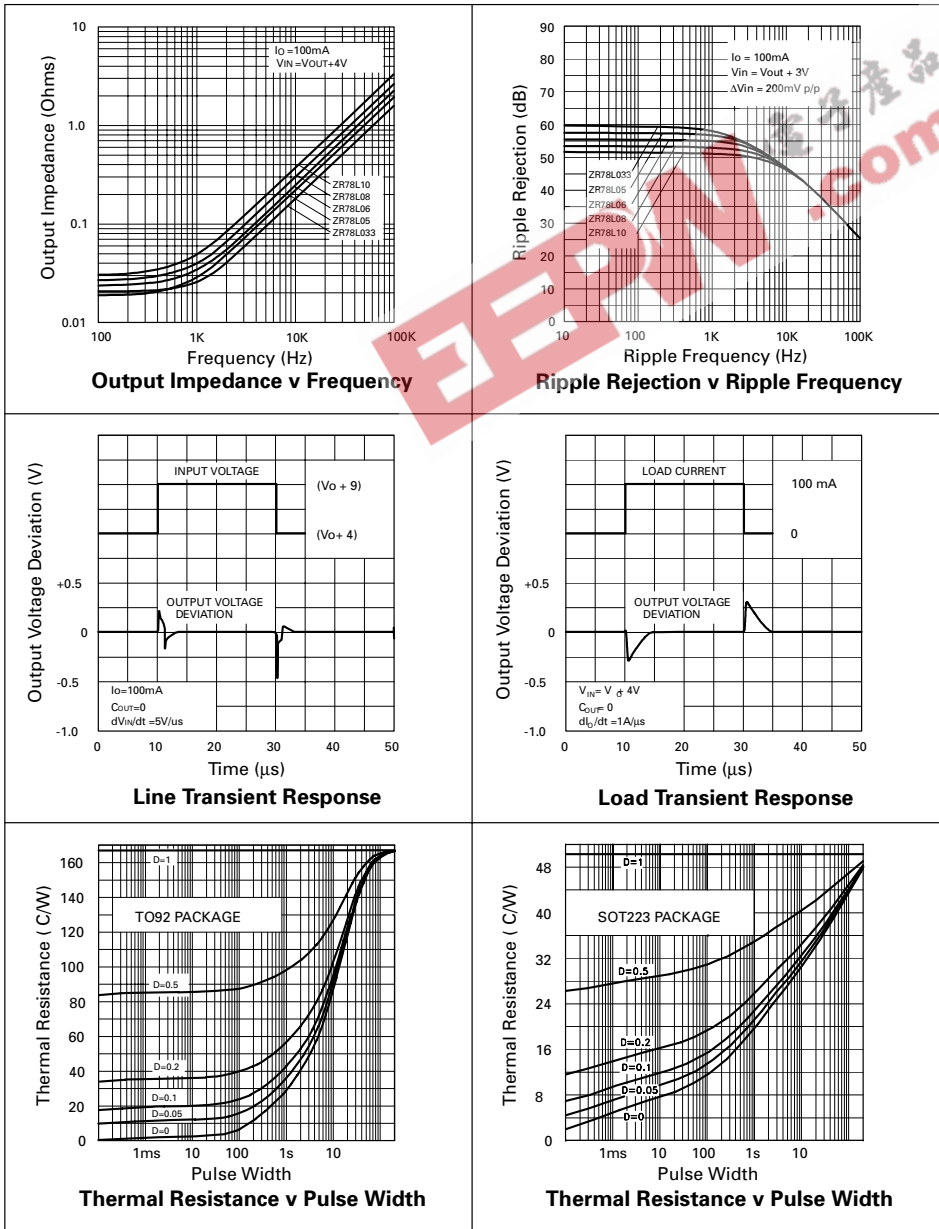

## ZR78L SERIES

### ZR78L07 TEST CONDITIONS (Unless otherwise stated): $T_j=25^{\circ}\text{C}$ , $I_O=100\text{mA}$ , $V_{in}=11\text{V}$

SYMBOL	PARAMETER	CONDITIONS	MIN.	TYP.	MAX.	UNITS
$V_O$	Output Voltage		6.825	7	7.175	V
		$I_O=1$ to 200mA $\tau$	6.72		7.28	V
		$V_{in}=9$ to 20V $I_O=1$ to 100mA $\tau$	6.72		7.28	V
$\Delta V_O$	Line Regulation	$V_{in}=9$ to 20V		10	40	mV
$\Delta V_O$	Load Regulation	$I_O=1$ to 200mA		5	25	mV
		$I_O=1$ to 100mA		2		mV
$I_q$	Quiescent Current	$\tau$		350	600	$\mu\text{A}$
$\Delta I_q$	Quiescent Current Change	$I_O=1$ to 200mA			100	$\mu\text{A}$
		$V_{in}=9$ to 20V			100	$\mu\text{A}$
$V_n$	Output Noise Voltage	$f=10\text{Hz}$ to 10kHz		75		$\mu\text{V rms}$
$\Delta V_{in}/\Delta V_O$	Ripple Rejection	$V_{in}=10$ to 18V $f=120\text{Hz}$	48	62		dB
$V_{in}$	Input Voltage Required To Maintain Regulation		9	8.7		V
$\Delta V_O/\Delta T$	Average Temperature Coefficient of $V_O$	$I_O=5.0\text{mA}$ $\tau$		0.1		$\text{mV}/^{\circ}\text{C}$

### ZR78L08 TEST CONDITIONS (Unless otherwise stated): $T_j=25^{\circ}\text{C}$ , $I_O=100\text{mA}$ , $V_{in}=12\text{V}$

SYMBOL	PARAMETER	CONDITIONS	MIN.	TYP.	MAX.	UNITS
$V_O$	Output Voltage		7.8	8	8.2	V
		$I_O=1$ to 200mA $\tau$	7.68		8.32	V
		$V_{in}=10$ to 20V $I_O=1$ to 100mA $\tau$	7.68		8.32	V
$\Delta V_O$	Line Regulation	$V_{in}=10$ to 20V		11	40	mV
$\Delta V_O$	Load Regulation	$I_O=1$ to 200mA		8	30	mV
		$I_O=1$ to 100mA		3		mV
$I_q$	Quiescent Current	$\tau$		350	600	$\mu\text{A}$
$\Delta I_q$	Quiescent Current Change	$I_O=1$ to 200mA			100	$\mu\text{A}$
		$V_{in}=10$ to 20V			100	$\mu\text{A}$
$V_n$	Output Noise Voltage	$f=10\text{Hz}$ to 10kHz		115		$\mu\text{V rms}$
$\Delta V_{in}/\Delta V_O$	Ripple Rejection	$V_{in}=11$ to 18V $f=120\text{Hz}$	44	60		dB
$V_{in}$	Input Voltage Required To Maintain Regulation		10	9.7		V
$\Delta V_O/\Delta T$	Average Temperature Coefficient of $V_O$	$I_O=5.0\text{mA}$ $\tau$		0.25		$\text{mV}/^{\circ}\text{C}$

$\tau = T_j = -55$  to  $125^{\circ}\text{C}$

# ZR78L SERIES

ZR78L048 ZR78L052  
ZR78L07 ZR78L085  
ZR78L12

## TYPICAL CHARACTERISTICS

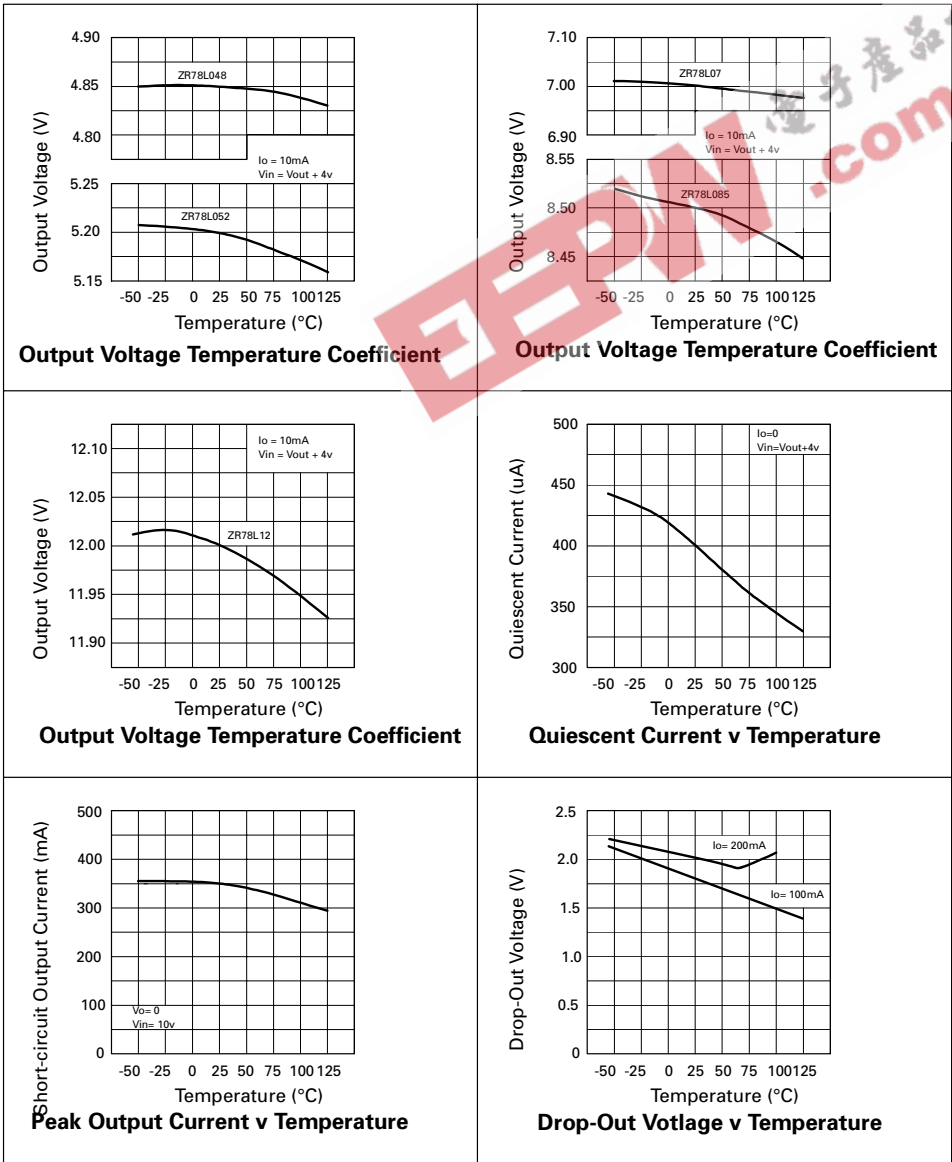

# ZR78L SERIES

## CONNECTION DIAGRAMS

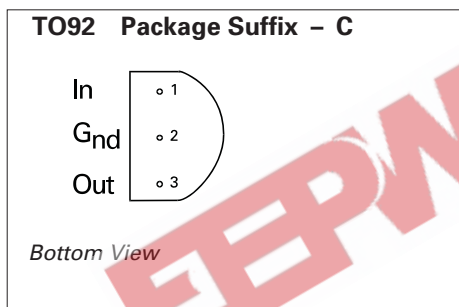
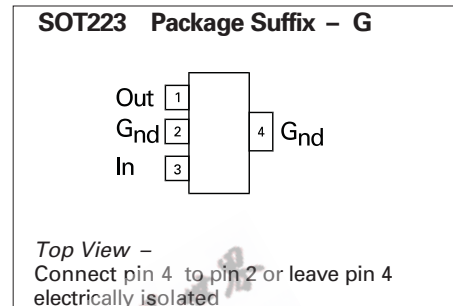
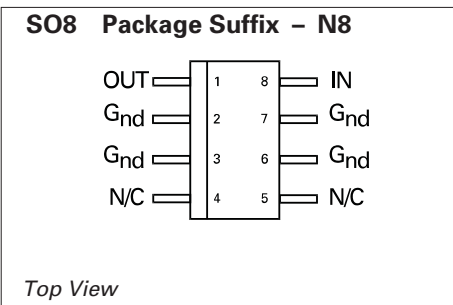

## OPTIONS

Voltage	Voltage Options	TO92	SOT223	SO8
2.85V	028	✓	✓	
3.0V	03	✓	✓	
3.3V	033	✓	✓	✓
4.0V	04	✓	✓	
4.8V	048	✓	✓	
5.0V	05	✓	✓	✓
5.2V	052	✓	✓	
5.7V	057	✓	✓	
6.0V	06	✓	✓	
7.0V	07	✓	✓	
8.0V	08	✓	✓	
8.5V	085	✓	✓	
9.0V	09	✓	✓	
10.0V	10	✓	✓	
12.0V	12	✓	✓	

## ORDERING INFORMATION

Part No	Package	Partmark
ZR78L s C	TO92	ZR78L s
ZR78L s G	SOT223	ZR78L s
ZR78L s N8	SO8	ZR78L s

### s Voltage Option

eg 3V device in TO92 package  
part number ZR78L03C  
part marked ZR78L03

eg 12V device in SOT223 package  
part number ZR78L12G  
part marked ZR78L12

eg 5V device in SO8 package  
part number ZR78L05N8  
part marked ZR78L05

ZR78L048 ZR78L052  
 ZR78L07 ZR78L085  
 ZR78L12

ZR78L  
 SERIES

TYPICAL CHARACTERISTICS

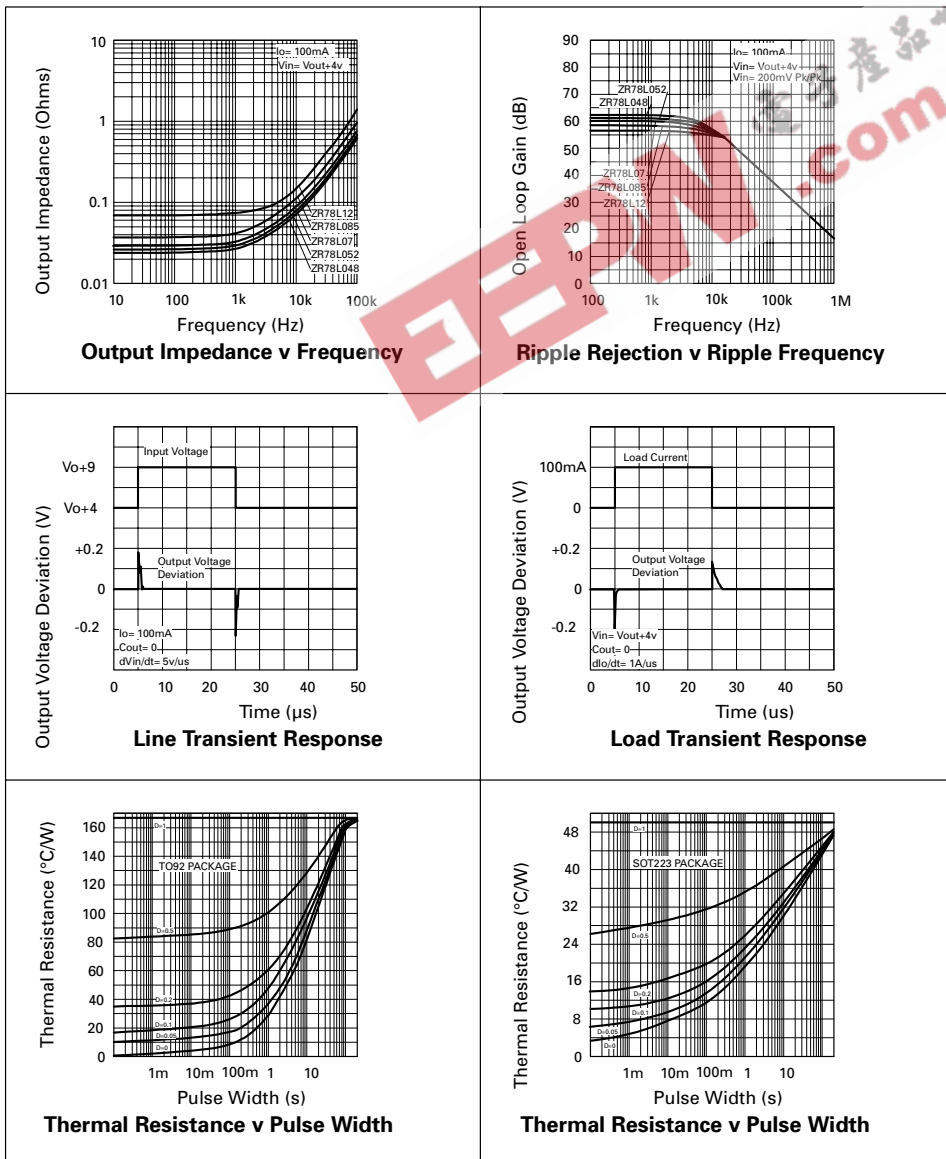



# ZR78L SERIES

## THERMAL CHARACTERISTICS

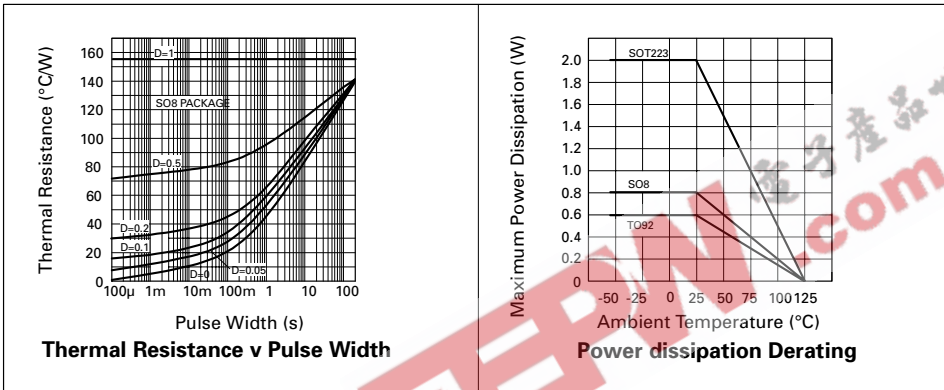

# ZR78L SERIES

## SCHEMATIC DIAGRAM

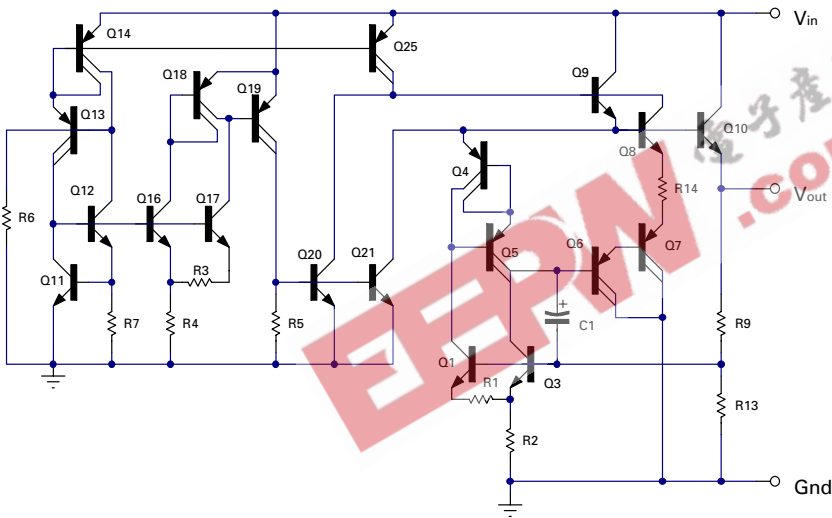

## APPLICATIONS

Fixed Output Regulator

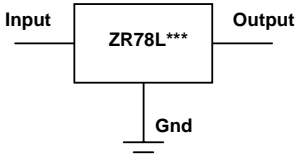

Adjustable Output Regulator

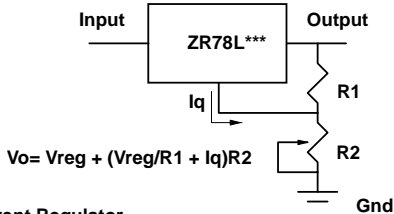

Current Regulator

