

Silicon PNP Power Transistors

2SA1105

DESCRIPTION

- With TO-3PN package
- High frequency
- High power dissipation

APPLICATIONS

- Audio power amplifier applications
- DC-DC converters

PINNING

PIN	DESCRIPTION
1	Base
2	Collector;connected to mounting base
3	Emitter

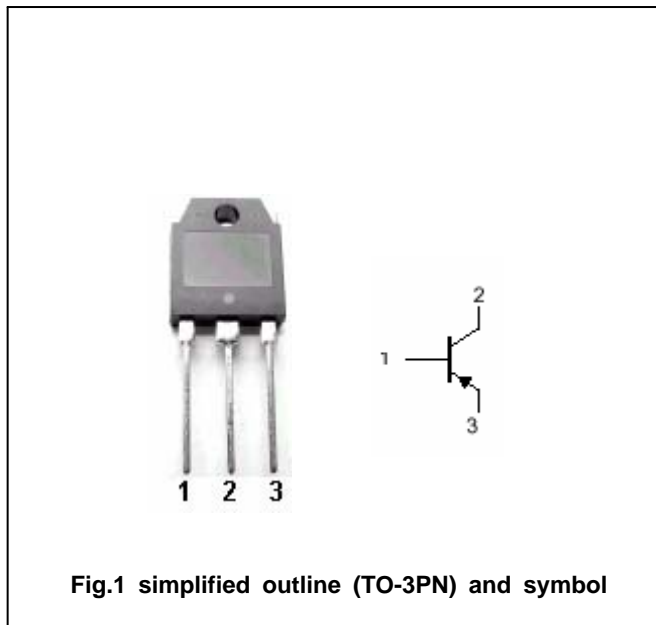

Fig.1 simplified outline (TO-3PN) and symbol

Absolute maximum ratings(Ta=)

SYMBOL	PARAMETER	CONDITIONS	VALUE	UNIT
V _{CBO}	Collector-base voltage	Open emitter	-120	V
V _{CEO}	Collector-emitter voltage	Open base	-120	V
V _{EBO}	Emitter-base voltage	Open collector	-6	V
I _C	Collector current		-9	A
P _C	Collector power dissipation	T _C =25	90	W
T _j	Junction temperature		150	
T _{stg}	Storage temperature		-55~150	

Silicon PNP Power Transistors

2SA1105

CHARACTERISTICS

T_j=25 unless otherwise specified

SYMBOL	PARAMETER	CONDITIONS	MIN	TYP.	MAX	UNIT
V _{(BR)CEO}	Collector-emitter breakdown voltage	I _C =-25mA ; I _B =0	-120			V
V _{CEsat}	Collector-emitter saturation voltage	I _C =-3A; I _B =-0.3A			-1.5	V
V _{BEsat}	Base-emitter saturation voltage	I _C =-3A; I _B =-0.3A			-1.8	V
I _{CBO}	Collector cut-off current	V _{CB} =-120V; I _E =0			-100	μ A
I _{EBO}	Emitter cut-off current	V _{EB} =-6V; I _C =0			-100	μ A
h _{FE}	DC current gain	I _C =-3A ; V _{CE} =4V	50		180	
f _T	Transition frequency	I _E =1A ; V _{CE} =-12V		20		MHz

Silicon PNP Power Transistors

2SA1105

PACKAGE OUTLINE

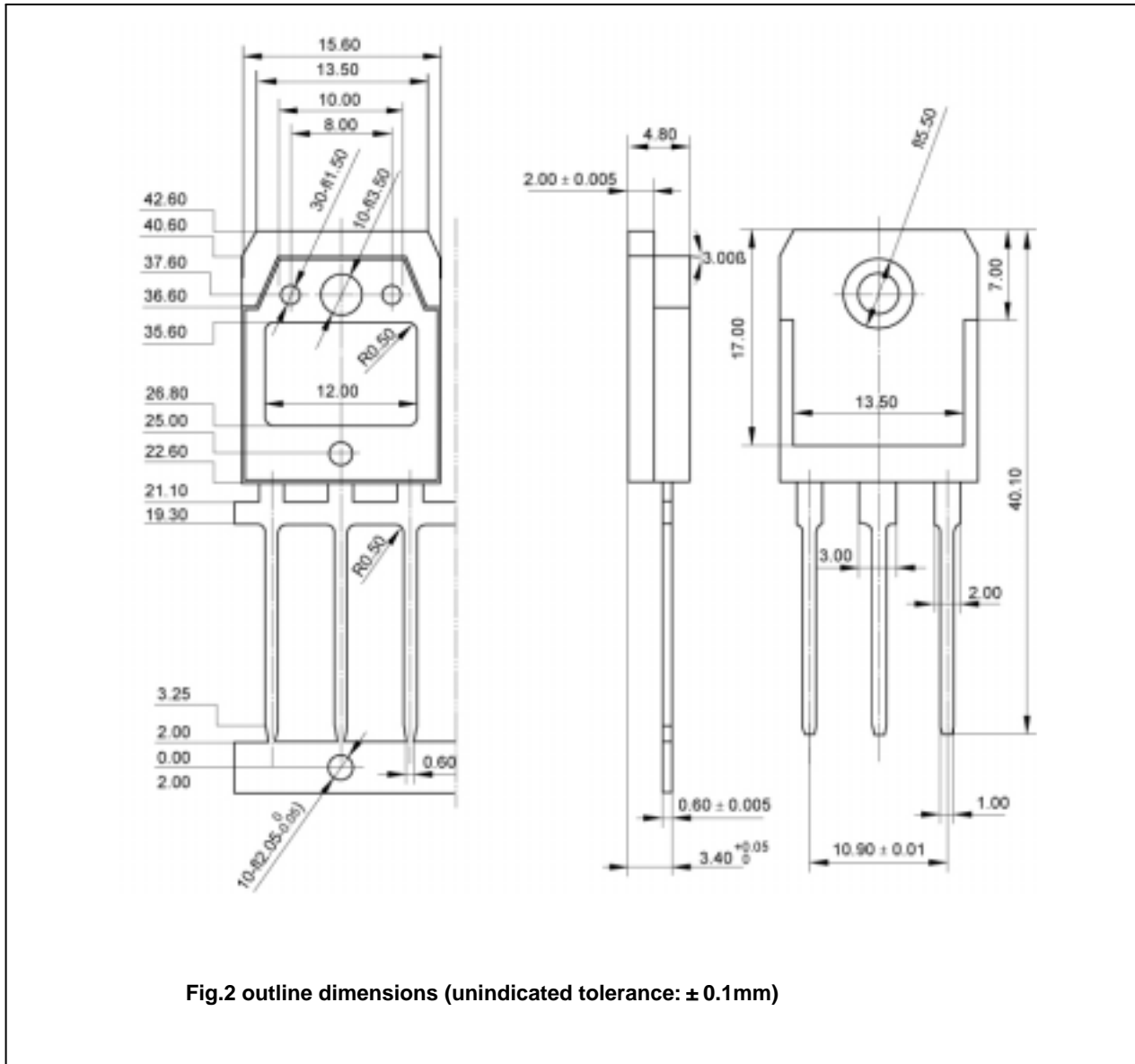

Fig.2 outline dimensions (unindicated tolerance: ± 0.1 mm)