

## Diode Lasers, High Brightness 0.6 to 8.5 W, 8xx nm 24xx Series

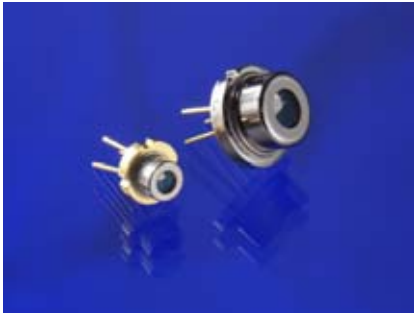

### Key Features

- 35 – 200  $\mu\text{m}$  apertures available
- High-efficiency, MOCVD quantum well design
- Open heat sink packages and encapsulated devices
- High reliability

The 24xx series diode lasers represent a breakthrough in high continuous wave (CW) optical power and ultra high brightness with unsurpassed reliability. The small emitting aperture, combined with low beam divergence, makes the 24xx series the highest brightness family of CW diode lasers available in the industry.

The 24xx series consists of partially coherent broad-area emitters, with relatively uniform emission over the emitting aperture. Operation is multi-longitudinal mode with a spectral envelope width of approximately 2 nm full width half maximum (FWHM). The far field beam divergence in the plane perpendicular to the P/N junction is nearly Gaussian, while the lateral beam profile exhibits a multiple-transverse mode pattern typical of broad-area emitters. The 24xx series offer up to 8.5 W of output from a 200  $\mu\text{m}$  aperture.

The high efficiency of the quantum well structure, combined with low thermal resistance epi-down chip mounting, provides minimum junction temperature at high optical power. Low junction temperature and low thermal resistance packages extend lifetime and increase reliability.

These diodes are mounted on conventional open heat sink packages and encapsulated devices, allowing for easy integration into user systems.

### Applications

- Solid-state laser pumping
- Medical/ophthalmic applications
- Free-space communication
- Beacons/illumination

2

**Dimensions Diagram**

(Specifications in inches [mm] unless otherwise noted.)

Standard Tolerances  
 inches: x.xx = ±0.02  
 x.xxx = ±0.010

mm: x.x = ±0.5  
 x.xx = ±0.25

Package Style: Open Heat Sink (A)

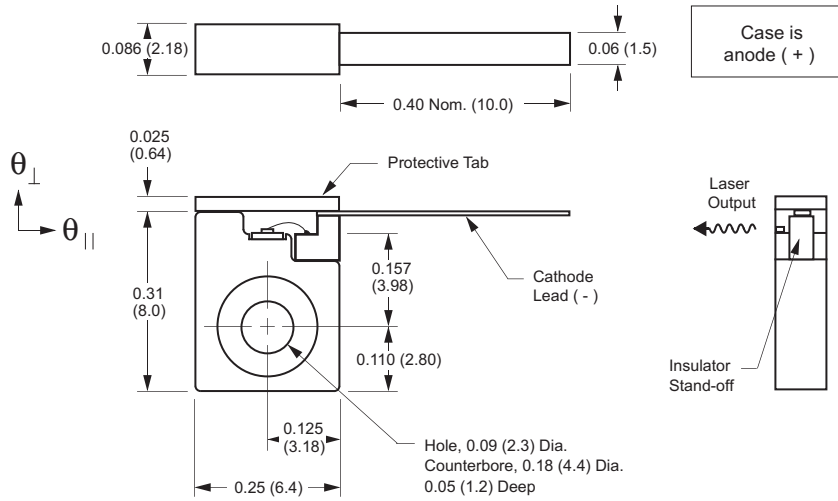

Package Style: SOT-148 Window (G1)

**Pinout**

**Pin Description**

Pin	Description
1	Laser cathode (-)
2	Laser anode, MPD cathode and case ground
3	Monitor photodiode anode (+)

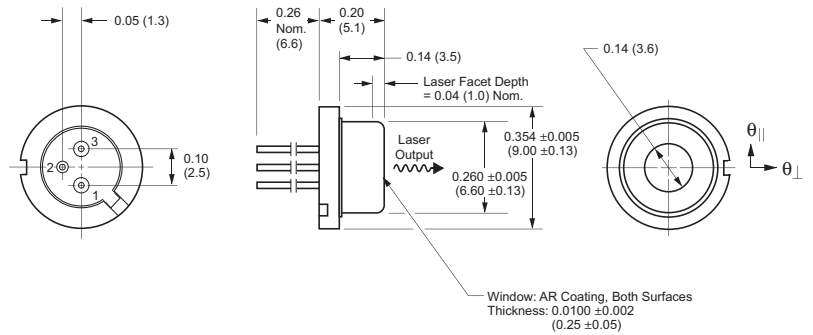

3

Dimensions Diagram

(Specifications in inches [mm] unless otherwise noted.)

Standard Tolerances

inches: x.xx = ±0.02  
x.xxx = ±0.010

mm: x.x = ±0.5  
x.xx = ±0.25

Package Style: TO-56 Window (J1)

Pinout

Pin	Description
1	Laser cathode (-)
2	Laser anode, MPD cathode and case ground
3	Monitor photodiode anode (+)

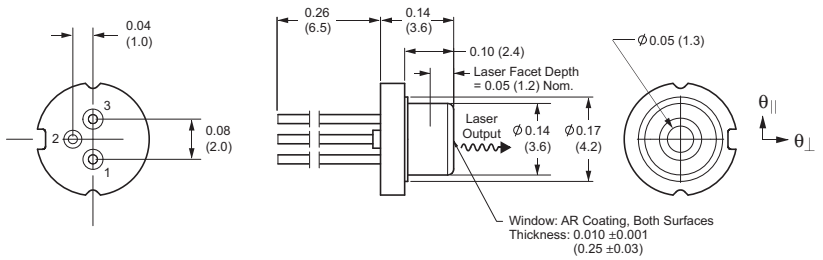

Package Style: Open Heat Sink (Y)

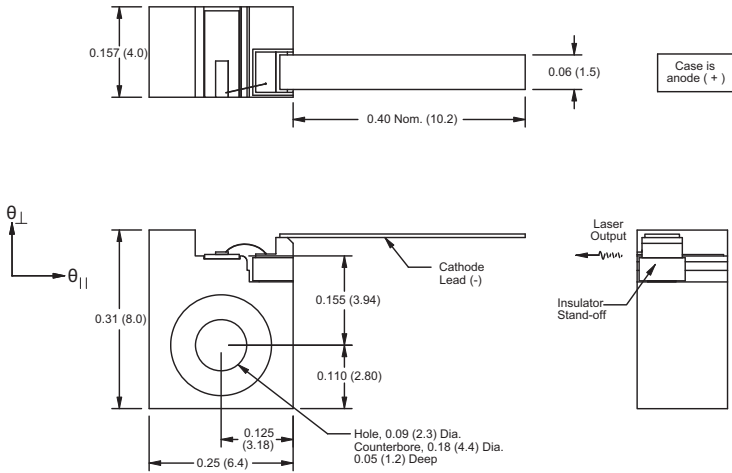

4

**Dimensions Diagram**

(Specifications in mm unless otherwise noted.)

Standard Tolerances  
 mm:     x.x = ±0.5  
           x.xx = ±0.25

Package Style: LX Submount

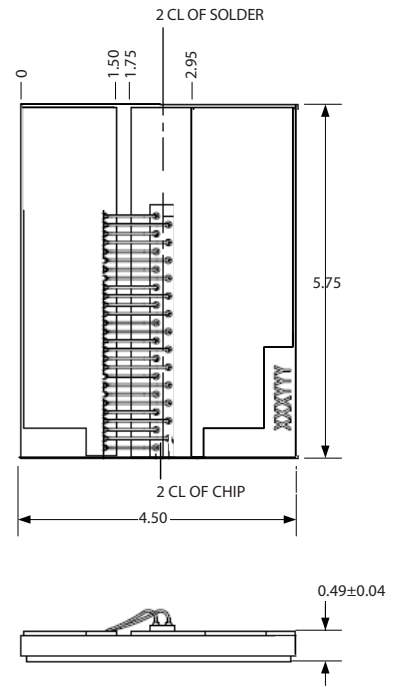
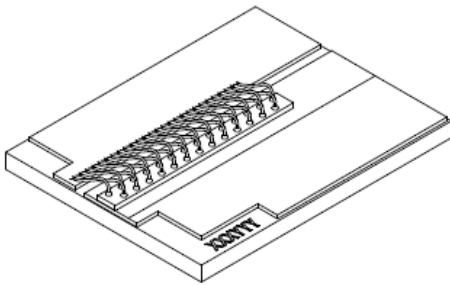

## 5

<b>Available Configurations</b>	<b>2445 Series</b> G-package	<b>2455 series</b> G-package A-block	<b>2465 Series</b> A-block	<b>2475 Series</b> A-block	<b>2495 Series</b> Y-block	<b>2496 Series</b> Y-block LX submount
---------------------------------	---------------------------------	--	-------------------------------	-------------------------------	-------------------------------	--

**Electro-optical Specifications**

Parameter	Symbol	2445-G1 0.6 W			2455-G1 1.2 W			Unit
		Min.	Typ.	Max.	Min.	Typ.	Max.	
<b>Laser Characteristics</b>								
CW output power	$P_o$	–	–	0.6	–	–	1.2	W
Center wavelength and tolerance	$\lambda_c$		808 ( $\pm 2.5$ ) 808 ( $\pm 7$ )			808 ( $\pm 2.5$ ) 808 ( $\pm 7$ )		nm
Spectral width	$\Delta\lambda$	–	2	–	–	2	–	nm
Slope efficiency	$\eta_d = P_o / (I_{op} - I_{th})$	1.00	1.15	–	1.00	1.15	–	W/A
Conversion efficiency	$\eta = P_o / (I_{op} V_{op})$	–	45	–	–	45	–	%
Emitting dimensions	W x H	–	100 x 1	–	–	100 x 1	–	$\mu\text{m}$
FWHM beam divergence								
Parallel to junction	$\theta_{//}$	–	7	10	–	7	10	degrees
Perpendicular to junction	$\theta_{\perp}$	–	30	33	–	30	33	degrees
90% power in angle beam divergence								
Parallel to junction	$\theta_{//,90\%}$	5.6	–	–	5.6	–	–	degrees
Threshold current	$I_{th}$	–	0.32	0.40	–	0.32	0.40	A
Operating current	$I_{op}$	–	0.85	1.00	–	1.35	1.55	A
Operating voltage	$V_{op}$	–	1.8	2.0	–	1.9	2.0	V
Series resistance	$R_s$	–	0.27	–	–	0.27	–	$\Omega$
Thermal resistance	$R_{th}$	–	12	–	–	12	–	$^{\circ}\text{C}/\text{W}$
Recommended case temperature	$T_c$	15	–	30	15	–	30	$^{\circ}\text{C}$
<b>Absolute Maximum and Minimum Ratings</b>								
Breakdown voltage	$V_b$	3	–	–	3	–	–	V
Case operating temperature	$T_{op}$	-20	–	50	-20	–	50	$^{\circ}\text{C}$
Storage temperature range	$T_{stg}$	-40	–	80	-40	–	80	$^{\circ}\text{C}$
Lead soldering temperature	$T_{is}$	–	–	250 (5 sec.)	–	–	250 (5 sec.)	$^{\circ}\text{C}$
<b>Monitor Photodiode</b>								
Sensitivity	–	0.2	–	10	0.2	–	10	$\mu\text{A}/\text{mW}$
Capacitance	–	–	6	–	–	6	–	pF
Breakdown voltage	$V_{bd}$	–	25	–	–	25	–	V
Operating voltage	$V_{op}$	–	10	–	–	10	–	V
<b>Reliability (at <math>P_o</math>, 25<math>^{\circ}\text{C}</math>)</b>								
Mean time to failure	MTTF	–	200,000	–	–	200,000	–	Hr

Note:

Typical value at 25 $^{\circ}\text{C}$  and 0.6 NA collection optics

## 6

## Electro-optical Specifications

Parameter	Symbol	2455-A1.2 W			2465-A 2.0 W			Unit
		Min.	Typ.	Max.	Min.	Typ.	Max.	
<b>Laser Characteristics</b>								
CW output power	$P_o$	–	–	1.2	–	–	2.0	W
Center wavelength and tolerance	$\lambda_c$		808 ( $\pm 2.5$ ) 808 ( $\pm 7$ )			808 ( $\pm 2.5$ ) 808 ( $\pm 7$ )		nm
Spectral width	$\Delta\lambda$	–	2	–	–	2	–	nm
Slope efficiency	$\eta_d = P_o/(I_{op}-I_{th})$	1.00	1.15	–	0.95	1.10	–	W/A
Conversion efficiency	$\eta = P_o/(I_{op}V_{op})$	–	45	–	–	45	–	%
Emitting dimensions	W x H	–	100 x 1	–	–	100 x 1	–	$\mu\text{m}$
FWHM beam divergence								
Parallel to junction	$\theta_{//}$	–	7	11	–	7	11	degrees
Perpendicular to junction	$\theta_{\perp}$	–	30	33	–	30	33	degrees
90% power in angle beam divergence								
Parallel to junction	$\theta_{//,90\%}$	5.6	–	–	5.6	–	–	degrees
Threshold current	$I_{th}$	–	0.32	0.40	–	0.65	0.75	A
Operating current	$I_{op}$	–	1.35	1.55	–	2.40	2.80	A
Operating voltage	$V_{op}$	–	1.9	2.0	–	1.8	2.0	V
Series resistance	$R_s$	–	0.27	–	–	0.09	0.12	$\Omega$
Thermal resistance	$R_{th}$	–	12	–	–	6	–	$^{\circ}\text{C}/\text{W}$
Recommended case temperature	$T_c$	15	–	30	15	–	30	$^{\circ}\text{C}$
<b>Absolute Maximum and Minimum Ratings</b>								
Breakdown voltage	$V_b$	3	–	–	3	–	–	V
Case operating temperature	$T_{op}$	-20	–	50	-20	–	50	$^{\circ}\text{C}$
Storage temperature range	$T_{stg}$	-40	–	80	-40	–	80	$^{\circ}\text{C}$
Lead soldering temperature	$T_{is}$	–	–	250 (5 sec.)	–	–	250 (5 sec.)	$^{\circ}\text{C}$
<b>Reliability (at <math>P_o</math>, 25<math>^{\circ}\text{C}</math>)</b>								
Mean time to failure	MTTF	–	200,000	–	–	200,000	–	Hr

Note:

Typical value at 25 $^{\circ}\text{C}$  and 0.6 NA collection optics

## 7

## Electro-optical Specifications

Parameter	Symbol	2475-A 3.0 W			2495-Y- 5.0 W			Unit
		Min.	Typ.	Max.	Min.	Typ.	Max.	
<b>Laser Characteristics</b>								
CW output power	$P_o$	–	–	3.0	–	–	5.0	W
Center wavelength and tolerance	$\lambda_c$		808 ( $\pm 2.5$ ) 808 ( $\pm 7$ )			808 ( $\pm 3$ ) 808 ( $\pm 7$ )		nm
Spectral width	$\Delta\lambda$	–	2	–	–	2	–	nm
Slope efficiency	$\eta_d = P_o/(I_{op}-I_{th})$	0.95	1.10	–	0.90	1.05	–	W/A
Conversion efficiency	$\eta = P_o/(I_{op}V_{op})$	–	45	–	–	45	–	%
Emitting dimensions	W x H	–	100 x 1	–	–	100 x 1	–	$\mu\text{m}$
FWHM beam divergence								
Parallel to junction	$\theta_{//}$	–	7	11	–	8	11	degrees
Perpendicular to junction	$\theta_{\perp}$	–	30	33	–	30	33	degrees
90% power in angle beam divergence								
Parallel to junction	$\theta_{//,90\%}$	5.6	–	–	5.6	–	–	degrees
Threshold current	$I_{th}$	–	0.65	0.75	–	0.90	1.05	A
Operating current	$I_{op}$	–	3.40	3.90	–	5.80	6.30	A
Operating voltage	$V_{op}$	–	1.9	2.1	–	1.9	2.1	V
Series resistance	$R_s$	–	0.09	0.12	–	0.06	0.09	$\Omega$
Thermal resistance	$R_{th}$	–	6	–	–	5	–	$^{\circ}\text{C}/\text{W}$
Recommended case temperature	$T_c$	15	–	30	15	–	30	$^{\circ}\text{C}$
<b>Absolute Maximum and Minimum Ratings</b>								
Breakdown voltage	$V_b$	3	–	–	3	–	–	V
Case operating temperature	$T_{op}$	-20	–	50	-20	–	50	$^{\circ}\text{C}$
Storage temperature range	$T_{stg}$	-40	–	80	-40	–	80	$^{\circ}\text{C}$
Lead soldering temperature	$T_{is}$	–	–	250 (5 sec.)	–	–	250 (5 sec.)	$^{\circ}\text{C}$
<b>Reliability (at <math>P_o</math>, 25<math>^{\circ}\text{C}</math>)</b>								
Mean time to failure	MTTF	–	100,000	–	–	–	–	Hr

Note:

Typical value at 25 $^{\circ}\text{C}$  and 0.6 NA collection optics

## 8

## Electro-optical Specifications

Parameter	Symbol	2496-Y- 8.5 W			Unit
		Min.	Typ.	Max.	
<b>Laser Characteristics</b>					
CW output power	$P_o$	–	–	8.5	W
Center wavelength and tolerance	$\lambda_c$		808 ( $\pm 3$ ) 808 ( $\pm 7$ )		nm
Spectral width	$\Delta\lambda$	–	2	–	nm
Slope efficiency	$\eta_d = P_o/(I_{op}-I_{th})$	1.05	1.12	–	W/A
Conversion efficiency	$\eta = P_o/(I_{op}V_{op})$	–	45	–	%
Emitting dimensions	W x H	–	200 x 1	–	$\mu\text{m}$
FWHM beam divergence					
Parallel to junction	$\theta_{//}$	–	9	12	degrees
Perpendicular to junction	$\theta_{\perp}$	–	30	33	degrees
Threshold current	$I_{th}$	–	1.9	2.0	A
Operating current	$I_{op}$	–	10.0	10.5	A
Operating voltage	$V_{op}$	–	1.9	2.1	V
Series resistance	$R_s$	–	0.03	–	$\Omega$
Thermal resistance	$R_{th}$	–	4.0	–	$^{\circ}\text{C}/\text{W}$
Recommended case temperature	$T_c$	15	–	30	$^{\circ}\text{C}$
<b>Absolute Maximum and Minimum Ratings</b>					
Breakdown voltage	$V_b$	3	–	–	V
Case operating temperature	$T_{op}$	-20	–	50	$^{\circ}\text{C}$
Storage temperature range	$T_{stg}$	-40	–	80	$^{\circ}\text{C}$
Lead soldering temperature	$T_{is}$	–	–	250 (5 sec.)	$^{\circ}\text{C}$
<b>Reliability (at <math>P_o</math>, 25<math>^{\circ}\text{C}</math>)</b>					
Mean time to failure	MTTF	–	40,000	–	Hr

Note:

Typical value at 25 $^{\circ}\text{C}$  and 0.6 NA collection optics



Typical Optical Characteristics

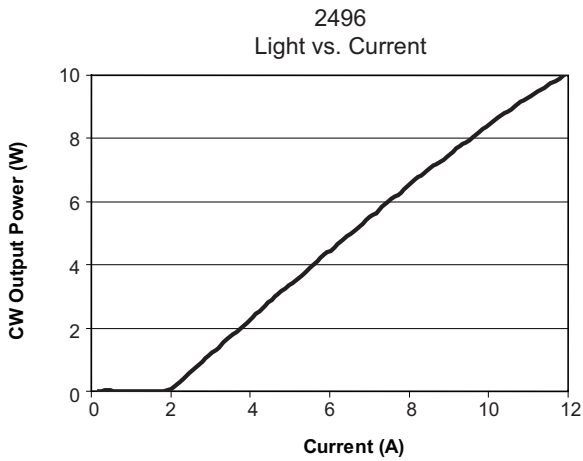
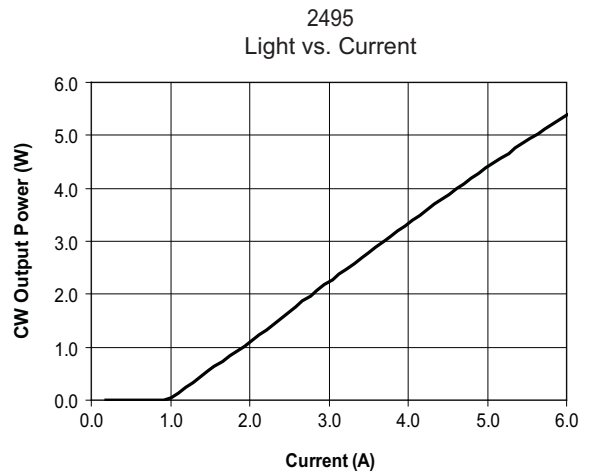
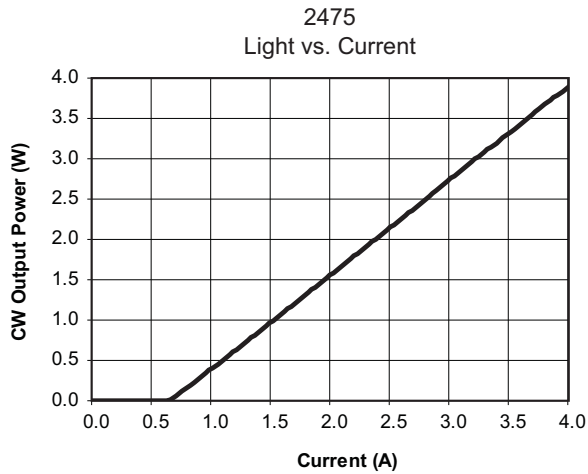
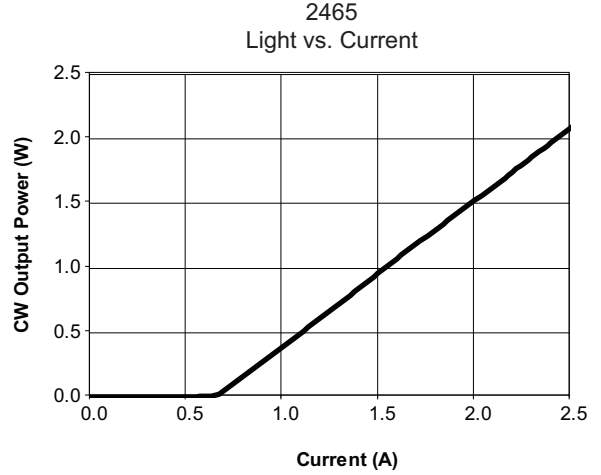
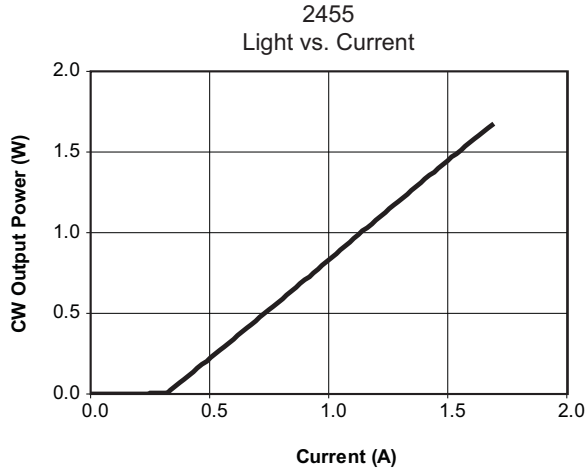

## Typical Optical Characteristics

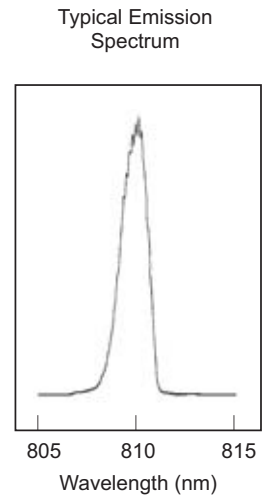
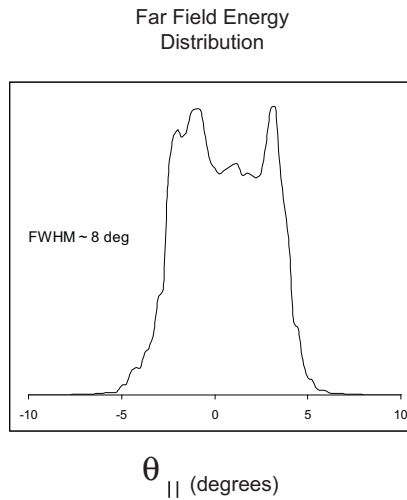
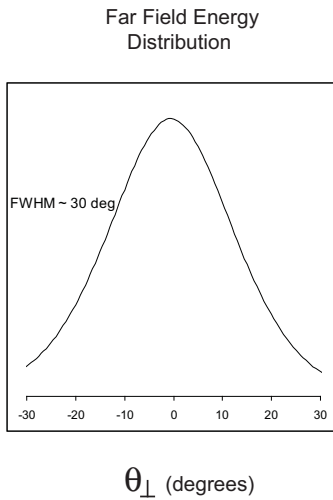

## Ordering Information

For more information on this or other products and their availability, please contact your local JDSU account manager or JDSU directly at 1-800-498-JDSU (5378) in North America and +800-5378-JDSU worldwide, or via e-mail at [customer.service@jdsu.com](mailto:customer.service@jdsu.com).

## Sample: 24-00135

Part Number	Power	Emitter Width	Wavelength	Package
Call for samples	0.2 – 1.2 W	35 – 100 $\mu\text{m}$	808 ( $\pm 2.5$ )	5.6 mm TO-56
Call for samples	0.2 – 1.2 W	35 – 100 $\mu\text{m}$	808 ( $\pm 7$ )	5.6 mm TO-56
24-00135	0.6 W	100 $\mu\text{m}$	808 ( $\pm 2.5$ )	9 mm SOT-148
24-00166	0.6 W	100 $\mu\text{m}$	808 ( $\pm 7$ )	9 mm SOT-148
24-00138	1.2 W	100 $\mu\text{m}$	808 ( $\pm 2.5$ )	9 mm SOT-148
24-00141	1.2 W	100 $\mu\text{m}$	808 ( $\pm 2.5$ )	Open Heat Sink "A"
24-00167	1.2 W	100 $\mu\text{m}$	808 ( $\pm 7$ )	9 mm SOT-148
24-00168	1.2 W	100 $\mu\text{m}$	808 ( $\pm 7$ )	Open Heat Sink "A"
24-00144	2 W	100 $\mu\text{m}$	808 ( $\pm 2.5$ )	Open Heat Sink "A"
24-00169	2 W	100 $\mu\text{m}$	808 ( $\pm 2.5$ )	9 mm SOT-148
24-00170	2 W	100 $\mu\text{m}$	808 ( $\pm 7$ )	Open Heat Sink "A"
24-00171	2 W	100 $\mu\text{m}$	808 ( $\pm 7$ )	9 mm SOT-148
24-00147	3 W	100 $\mu\text{m}$	808 ( $\pm 2.5$ )	Open Heat Sink "A"
24-00172	3 W	100 $\mu\text{m}$	808 ( $\pm 7$ )	Open Heat Sink "A"
24-00150	5 W	100 $\mu\text{m}$	808 ( $\pm 3$ )	Open Heat Sink "Y"
24-00173	5 W	100 $\mu\text{m}$	808 ( $\pm 7$ )	Open Heat Sink "Y"
24-00178	8.5 W	200 $\mu\text{m}$	808 ( $\pm 3$ )	Open Heat Sink "Y"
24-00179	8.5 W	200 $\mu\text{m}$	808 ( $\pm 7$ )	Open Heat Sink "Y"
24-00180	8.5 W	200 $\mu\text{m}$	808 ( $\pm 3$ )	LX submount
24-00181	8.5 W	200 $\mu\text{m}$	808 ( $\pm 7$ )	LX submount

**User Safety**
**Safety and Operating Considerations**

The laser light emitted from this diode laser is invisible and may be harmful to the human eye. Avoid looking directly into the diode laser, into the collimated beam along its optical axis, or directly into the fiber when the device is in operation.

**CAUTION: THE USE OF OPTICAL INSTRUMENTS WITH THIS PRODUCT WILL INCREASE EYE HAZARD.**

Operating the diode laser outside of its maximum ratings may cause device failure or a safety hazard. Power supplies used with the component must be employed such that the maximum peak optical power cannot be exceeded.

CW diode lasers may be damaged by excessive drive current or switching transients. When power supplies are used, the diode laser should be connected with the main power on and the output voltage at zero. The current should be increased slowly while the diode laser output power and the drive current are monitored.

Device degradation accelerates with increased temperature, and therefore careful attention to minimize the case temperature is advised. For example, life expectancy will decrease by a factor of four if the case is operated at 50°C rather than 30°C.

A proper heatsink for the diode laser on a thermal radiator will greatly enhance laser life. Firmly mount the laser on a radiator with a thermal impedance of less than 0.5°C/W for increased reliability.

**ESD PROTECTION** – Electrostatic discharge is the primary cause of unexpected diode laser failure. Take extreme precaution to prevent ESD. Use wrist straps, grounded work surfaces and rigorous antistatic techniques when handling diode lasers.

**Labeling**
**21 CFR 1040.10 Compliance**

Because of the small size of these devices, each of the labels shown is attached to the individual shipping container. They are illustrated here to comply with 21 CFR 1040.10 as applicable under the Radiation Control for Health and Safety Act of 1968.

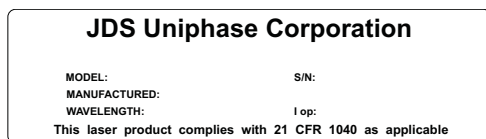
**Serial Number Identification Label**

**Output Power Danger Labels**

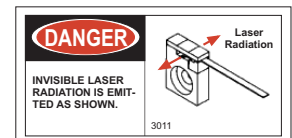
- 2455 Series
- 2465 Series
- 2475 Series
- 2495 Series
- 2496 Series

**Package Aperture Label**

A Package Diodes