

Hardware Option

- NN** - No Jackpost, No Threaded Insert
- PN** - Extended Jackpost for .062" (1.6) PCB, No Threaded Insert
- RN** - Extended Jackpost for .196" (5.0) PCB, No Threaded Insert
- NU** - Threaded Insert Only, No Jackposts
- PU** - Short Jackpost and Threaded Insert

Rear Panel Jackposts with Threaded Insert:

- R6U** - 0.125" (3.2) Panel
- R5U** - 0.094" (2.4) Panel
- R4U** - 0.062" (1.6) Panel
- R3U** - 0.047" (1.2) Panel
- R2U** - 0.031" (0.8) Panel

Jack screw Options:

- M** - Hex Head Jackscrews
- S** - Slot Head Jackscrews

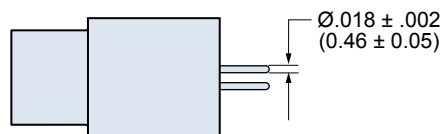

Printed Circuit Board Micro-D Filter Connectors. These vertical mount PCB connectors are ideal for flexible circuit or motherboard applications.

Integral Board Standoffs and Pre-Tinned Tails—These connectors are solder dipped (63/37 SnPb) and feature a full complement of mounting hardware options.

240-031
Micro-D Filter Connectors
Vertical Mount Printed Circuit Board



TABLE I: SHELL FINISH

SYM	MATERIAL	FINISH DESCRIPTION
1	Aluminum	Cadmium
2	Aluminum	Nickel
5	Aluminum	Gold
6	Aluminum	Chem Film
33	Aluminum	Ni-PTFE 1000 Hour Grey™

TABLE II: CAPACITOR ARRAY CODE CAPACITANCE RANGE*

CLASS	PI - CIRCUIT (pF)	C - CIRCUIT (pF)
A	38,000 - 56,000	19,000 - 28,000
B	32,000 - 45,000	16,000 - 22,500
C	18,000 - 33,000	9,000 - 16,500
D	8,000 - 12,000	4,000 - 6,000
E	3,300 - 5,000	1,650 - 2,500
F	800 - 1,300	400 - 650
G	400 - 600	200 - 300

MICRO-D FILTER PIGTAIL DIMENSIONS

Layout	A Max.		B		C Max.		D Max.		E Max.		F	
	In.	mm.	In. ± .003	mm. ± 0.08	In.	mm.	In.	mm.	In.	mm.	In. ± .004	mm. ± 0.10
9P	.785	19.94	.565	14.35	.333	8.46	.184	4.67	.310	7.87	.183	4.65
9S	.785	19.94	.565	14.35	.400	10.16	.250	6.35	.310	7.87	.195	4.95
15P	.935	23.75	.715	18.16	.483	12.27	.184	4.67	.310	7.87	.183	4.65
15S	.935	23.75	.715	18.16	.551	14.00	.250	6.35	.310	7.87	.195	4.95
21P	1.085	27.56	.865	21.97	.633	16.08	.184	4.67	.310	7.87	.183	4.65
21S	1.085	27.56	.865	21.97	.701	17.81	.250	6.35	.310	7.87	.195	4.95
25P	1.185	30.01	.965	24.51	.733	18.62	.184	4.67	.310	7.87	.183	4.65
25S	1.185	30.01	.965	24.51	.801	20.35	.250	6.35	.310	7.87	.195	4.95
31P	1.335	33.91	1.115	28.32	.883	22.43	.184	4.67	.310	7.87	.183	4.65
31S	1.335	33.91	1.115	28.32	.951	24.16	.250	6.35	.310	7.87	.195	4.95
37P	1.485	37.72	1.265	32.13	1.033	26.24	.184	4.67	.310	7.87	.183	4.65
37S	1.485	37.72	1.265	32.13	1.101	27.96	.250	6.35	.310	7.87	.195	4.95

Connector Supplied Without Hardware

Connector Supplied With Threaded Inserts

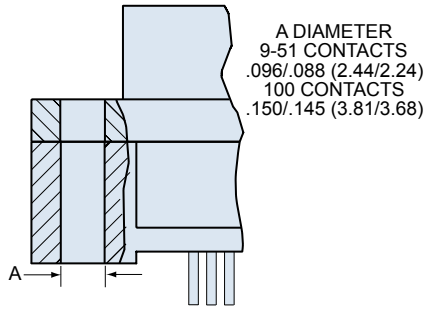

A DIAMETER
9-51 CONTACTS
.096/ .088 (2.44/2.24)
100 CONTACTS
.150/ .145 (3.81/3.68)

NN Style
Thru-Hole, No Hardware

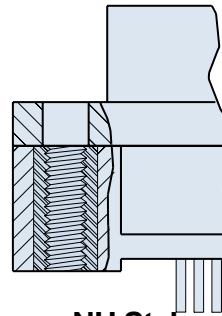

9-51 CONTACTS
NO. 2-56 UNC-2B
100 CONTACTS
NO. 4-40 UNC-2B

NU Style
Threaded Insert

Jackpost and Threaded Insert

Rear Panel Jackpost and Threaded Insert

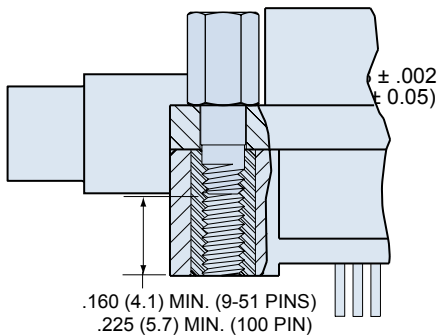

PU Style
Jackpost with Threaded Insert

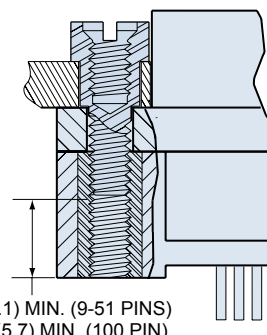

RU Style
Rear Panel Jackpost with Threaded Insert

Extended Jackpost

Jackscrew, Hex

Jackscrew, Slot

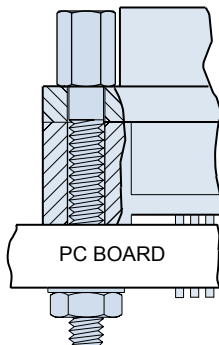

PN Style for .062" PCB
RN Style for .196" PCB

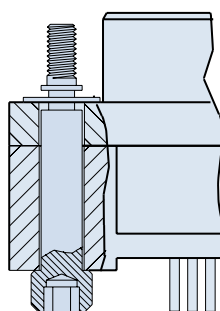

M Style
Hex Head Jackscrew with E-Ring

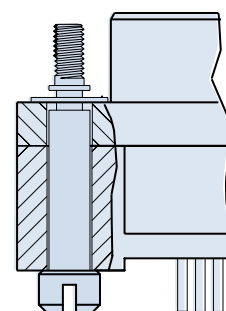

S Style
Slot Head Jackscrew with E-Ring

240-031
Micro-D Filter Connectors
Vertical Mount PCB Pin Connector Layouts



Micro-D
Connectors

PC Tail Diameter .018 ± .002 (0.46 ± 0.05)
Contact numbers shown are for pin connectors. Reverse for socket.

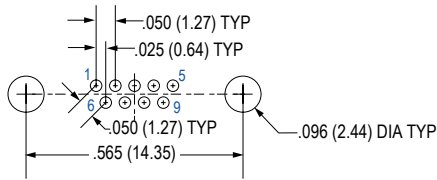

9 Contacts

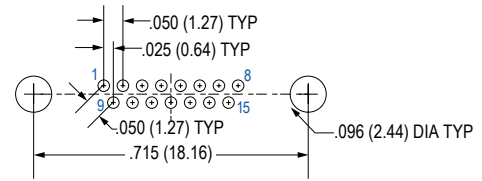

15 Contacts

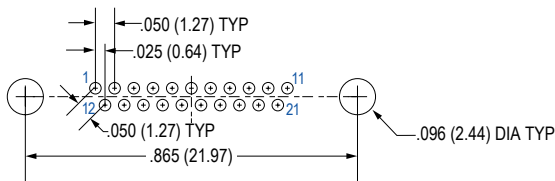

21 Contacts

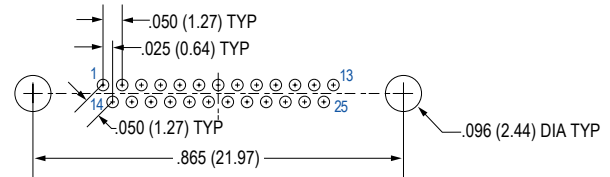

25 Contacts

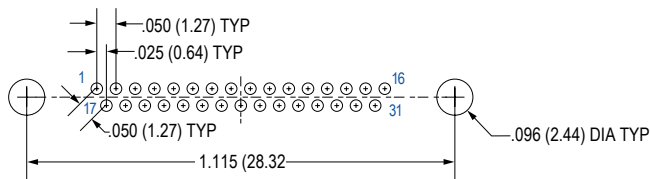

31 Contacts

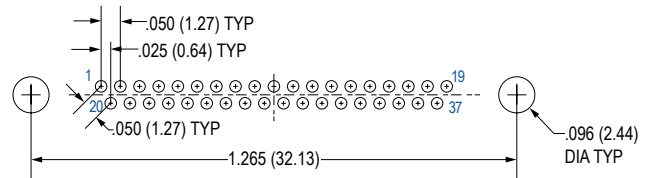

37 Contacts

D