

# Micro-D Filter Connectors Right Angle Printed Circuit Board



**Right Angle Board Mount Filtered Micro-D's.** These connectors feature low-pass EMI filtering in a right angle header for PCB termination.

**Key Features** include gold plated TwistPin contacts, machined aluminum shells, and either Pi or C filter elements. These environmentally sealed connectors are designed to meet the requirements of MIL-DTL-83513.

**.100" x .100" Board Spacing** – These connectors are similar to “CBR” style Micro-D's and share the same board footprint, allowing retrofit to existing boards.

## HOW TO ORDER MICRO-D FILTERED RIGHT ANGLE PCB

F

Series	Shell Finish	Number of Contacts	Contact Type	Filter Type	Filter Class	Hardware Option	Tail Length	
240-034	1 – Cadmium	9	P Pin	C C Filter	A	NN – No Jackpost, No Threaded Insert	Length in Inches	
	2 – Nickel	15			B	PN – Jackpost, No Threaded Insert		
	4 – Black Anodize	21			C	NU – Threaded Insert Only, No Jackposts		
		25	S Socket	P Pi Filter	D	PU – Jackpost and Threaded Insert		
	5 – Gold	31			E	<b>Rear Panel Jackposts With Threaded Inserts</b>		
	6 – Chem Film	37			F			R6U – 0.125" (3.2) Panel
								G
								R4U – 0.062" (1.6) Panel
					R3U – 0.047" (1.2) Panel			
					R2U – 0.031" (0.8) Panel			

### Sample Part Number

240-034 – 2 – 37 S P E PU – .080

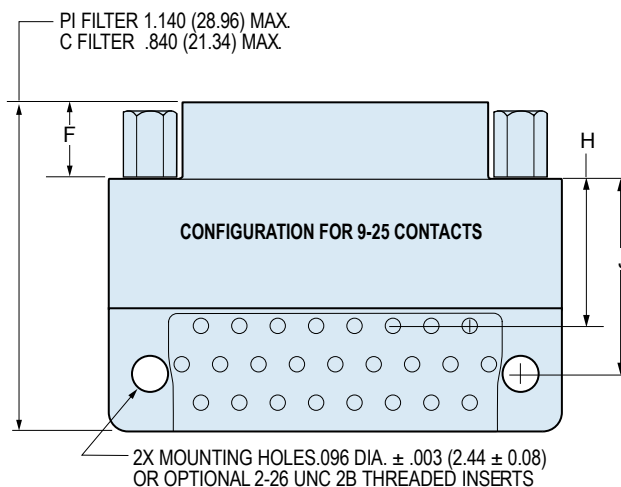
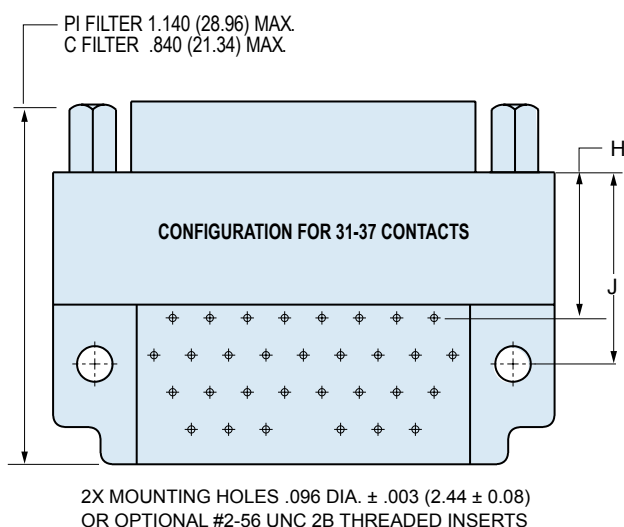
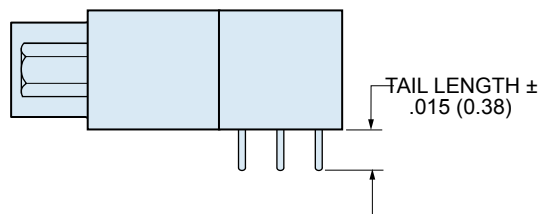
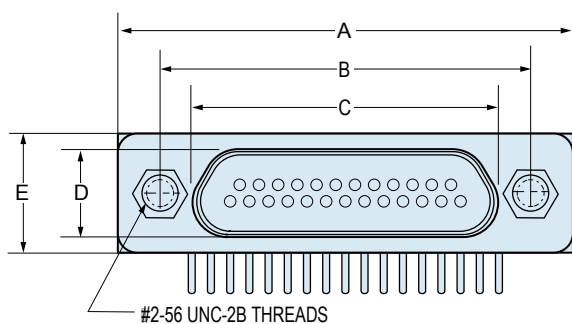

F

## DIMENSIONS

Layout	A Max.		B		C Max.		D Max.		E Max.		F		G Max.		C Filter				Pi Filter			
	In.	mm.	In.	mm.	In.	mm.	In.	mm.	In.	mm.	In.	mm.	In.	mm.	In.	mm.	In.	mm.	In.	mm.	In.	mm.
<b>9P</b>	.785	19.94	.565	14.35	.333	8.46	.184	4.67	.310	7.87	.183	4.65	.420	10.67	.440	11.18	.460	11.68	.740	18.80	.760	19.30
<b>9S</b>	.785	19.94	.565	14.35	.400	10.16	.250	6.35	.310	7.87	.195	4.95	.420	10.67	.440	11.18	.460	11.68	.740	18.80	.760	19.30
<b>15P</b>	.935	23.75	.715	18.16	.483	12.27	.184	4.67	.310	7.87	.183	4.65	.420	10.67	.340	8.64	.460	11.68	.640	16.26	.760	19.30
<b>15S</b>	.935	23.75	.715	18.16	.551	14.00	.250	6.35	.310	7.87	.195	4.95	.420	10.67	.340	8.64	.460	11.68	.640	16.26	.760	19.30
<b>21P</b>	1.085	27.56	.865	21.97	.633	16.08	.184	4.67	.310	7.87	.183	4.65	.420	10.67	.340	8.64	.460	11.68	.640	16.26	.760	19.30
<b>21S</b>	1.085	27.56	.865	21.97	.701	17.81	.250	6.35	.310	7.87	.195	4.95	.420	10.67	.340	8.64	.460	11.68	.640	16.26	.760	19.30
<b>25P</b>	1.185	30.01	.965	24.51	.733	18.62	.184	4.67	.310	7.87	.183	4.65	.420	10.67	.340	8.64	.460	11.68	.640	16.26	.760	19.30
<b>25S</b>	1.185	30.01	.965	24.51	.801	20.35	.250	6.35	.310	7.87	.195	4.95	.420	10.67	.340	8.64	.460	11.68	.640	16.26	.760	19.30
<b>31P</b>	1.335	33.91	1.115	28.32	.883	22.43	.184	4.67	.310	7.87	.183	4.65	.520	13.21	.340	8.64	.460	11.68	.640	16.26	.760	19.30
<b>31S</b>	1.335	33.91	1.115	28.32	.951	24.16	.250	6.35	.310	7.87	.195	4.95	.520	13.21	.340	8.64	.460	11.68	.640	16.26	.760	19.30
<b>37P</b>	1.485	37.72	1.265	32.13	1.033	26.24	.184	4.67	.310	7.87	.183	4.65	.520	13.21	.340	8.64	.460	11.68	.640	16.26	.760	19.30
<b>37S</b>	1.485	37.72	1.265	32.13	1.101	27.96	.250	6.35	.310	7.87	.195	4.95	.520	13.21	.340	8.64	.460	11.68	.640	16.26	.760	19.30

# Micro-D Filter Connectors Right Angle Printed Circuit Board



## MICRO-D FILTER RIGHT ANGLE PCB LAYOUTS— PIN CONNECTOR

PC Tail Diameter  $.018 \pm .002$  ( $0.46 \pm 0.05$ )

Contact numbers shown are for pin connectors.

Patterns shown are for connector mounting side of PC board.

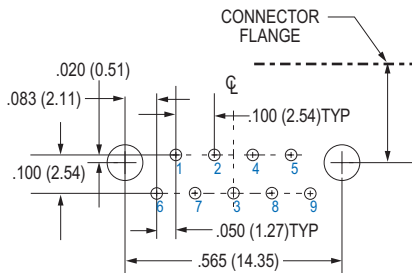

**9 Contacts**

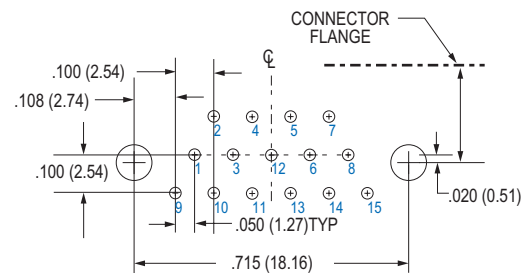

**15 Contacts**

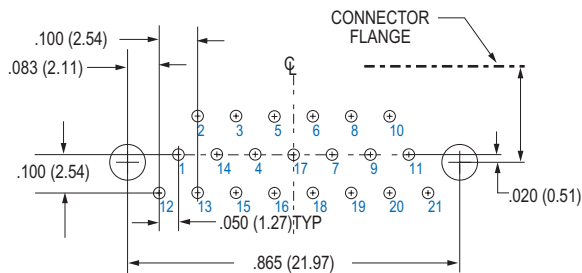

**21 Contacts**

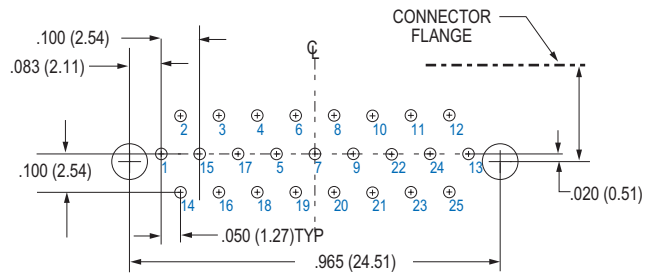

**25 Contacts**

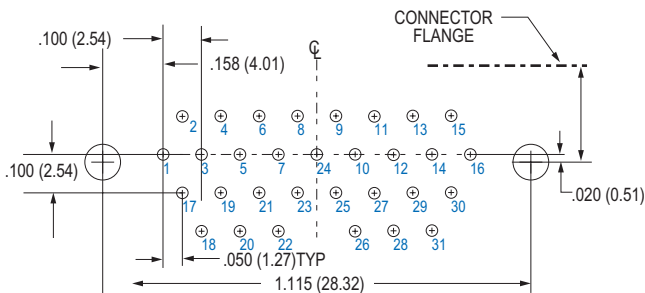

**31 Contacts**

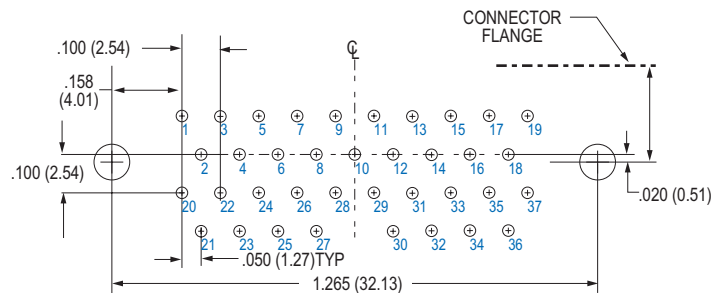

**37 Contacts**

**F**

## MICRO-D FILTER RIGHT ANGLE PCB LAYOUTS— SOCKET CONNECTOR

PC Tail Diameter  $.018 \pm .002$  ( $0.46 \pm 0.05$ )

Contact numbers shown are for socket connectors.

Patterns shown are for connector mounting side of PC board.

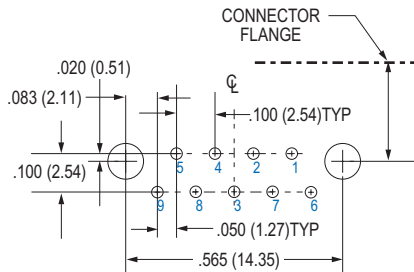

**9 Contacts**

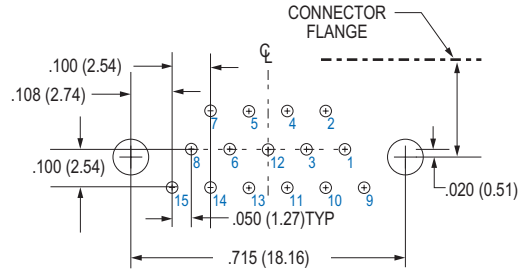

**15 Contacts**

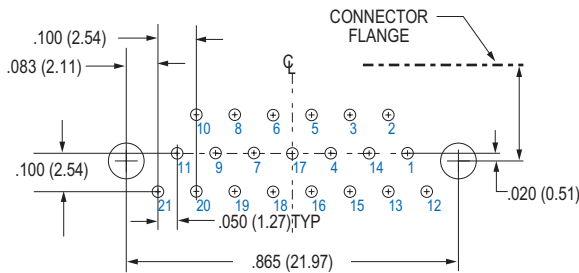

**21 Contacts**

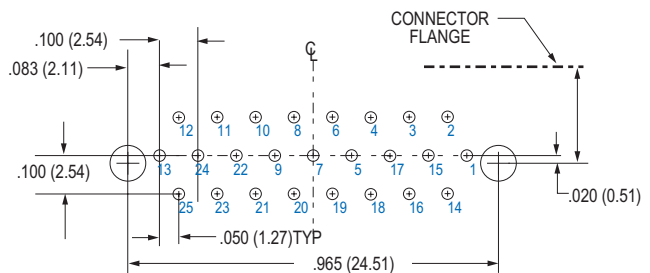

**25 Contacts**

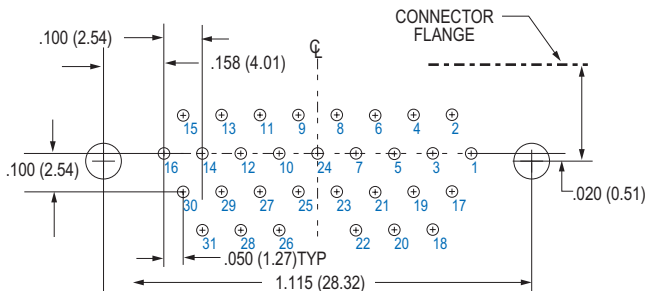

**31 Contacts**

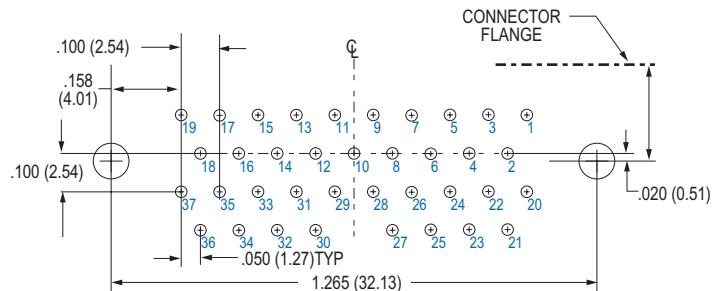

**37 Contacts**