

## Silicon NPN Power Transistors

2SC4511

**DESCRIPTION**

- With TO-220F package
- Complement to type 2SA1725

**APPLICATIONS**

- Audio and general purpose

**PINNING**

PIN	DESCRIPTION
1	Base
2	Collector
3	Emitter

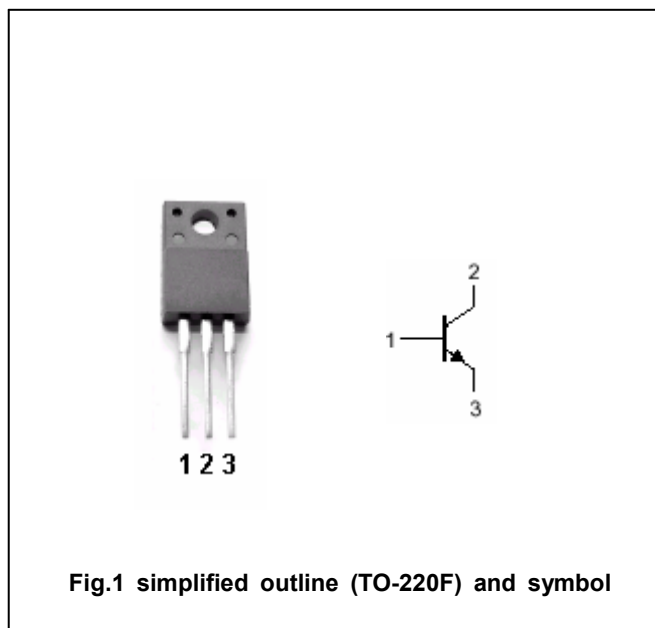
**Absolute maximum ratings (Ta=25℃)**

SYMBOL	PARAMETER	CONDITIONS	VALUE	UNIT
$V_{CBO}$	Collector-base voltage	Open emitter	120	V
$V_{CEO}$	Collector-emitter voltage	Open base	80	V
$V_{EBO}$	Emitter-base voltage	Open collector	6	V
$I_C$	Collector current		6	A
$I_B$	Base current		3	A
$P_C$	Collector dissipation	$T_C=25^\circ\text{C}$	30	W
$T_j$	Junction temperature		150	℃
$T_{stg}$	Storage temperature		-55~150	℃

## Silicon NPN Power Transistors

## 2SC4511

## CHARACTERISTICS

T<sub>j</sub>=25°C unless otherwise specified

SYMBOL	PARAMETER	CONDITIONS	MIN	TYP.	MAX	UNIT
V <sub>(BR)CEO</sub>	Collector-emitter breakdown voltage	I <sub>C</sub> =25mA ; I <sub>B</sub> =0	80			V
V <sub>CEsat</sub>	Collector-emitter saturation voltage	I <sub>C</sub> =2A; I <sub>B</sub> =0.2A			0.5	V
I <sub>CBO</sub>	Collector cut-off current	V <sub>CB</sub> =120V; I <sub>E</sub> =0			10	μA
I <sub>EBO</sub>	Emitter cut-off current	V <sub>EB</sub> =6V; I <sub>C</sub> =0			10	μA
h <sub>FE</sub>	DC current gain	I <sub>C</sub> =2A ; V <sub>CE</sub> =4V	50		180	
C <sub>OB</sub>	Output capacitance	I <sub>E</sub> =0; V <sub>CB</sub> =10V; f=1MHz		110		pF
f <sub>T</sub>	Transition frequency	I <sub>E</sub> =-0.5A ; V <sub>CE</sub> =12V		20		MHz

## Switching times

t <sub>on</sub>	Turn-on time	I <sub>C</sub> =3.0A I <sub>B1</sub> =-I <sub>B2</sub> =0.3A V <sub>CC</sub> =30V ,R <sub>L</sub> =10Ω		0.16		μs
t <sub>s</sub>	Storage time			2.60		μs
t <sub>f</sub>	Fall time			0.34		μs

◆ h<sub>FE</sub> Classifications

O	P	Y
50-100	70-140	90-180

Silicon NPN Power Transistors

2SC4511

PACKAGE OUTLINE

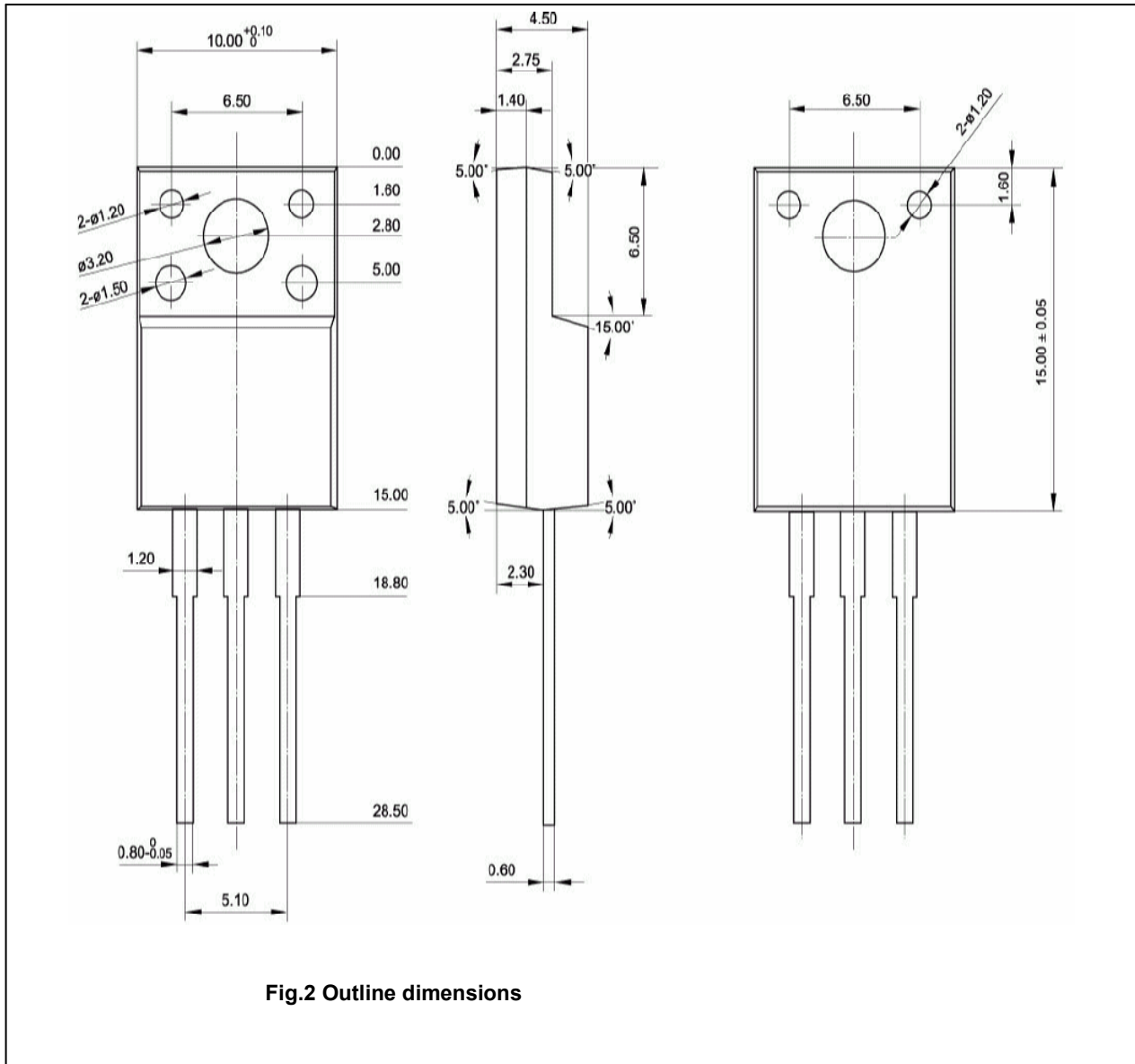

Silicon NPN Power Transistors

2SC4511

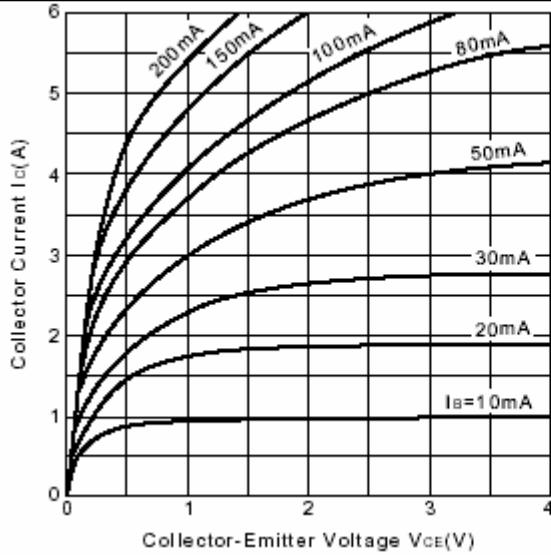

Fig.3 Static Characteristic

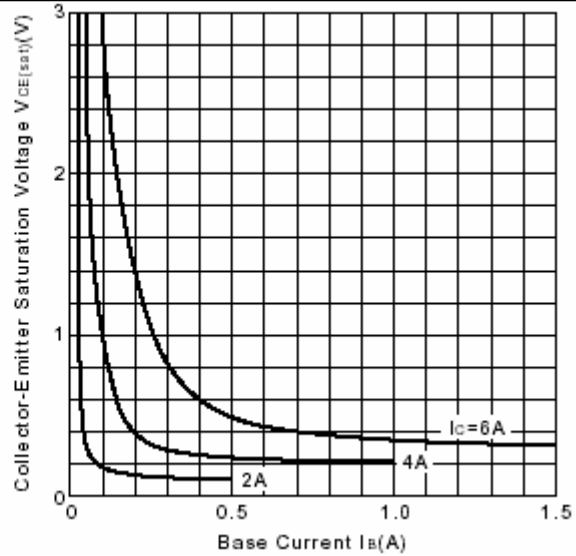

Fig.4  $V_{CE(sat)}$ - $I_B$  Characteristics

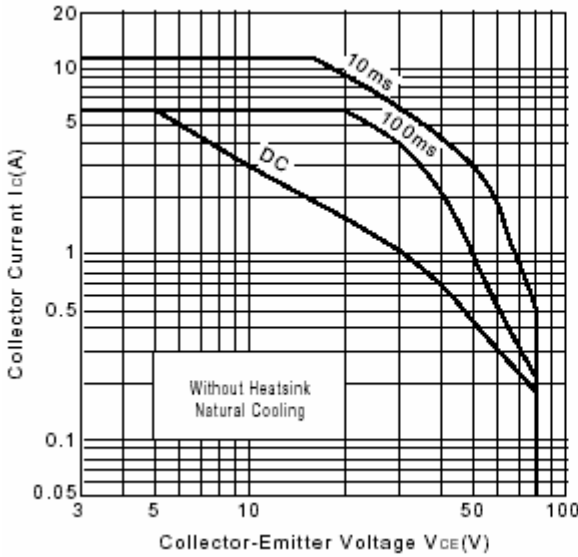

Fig.5 Safe Operating Area

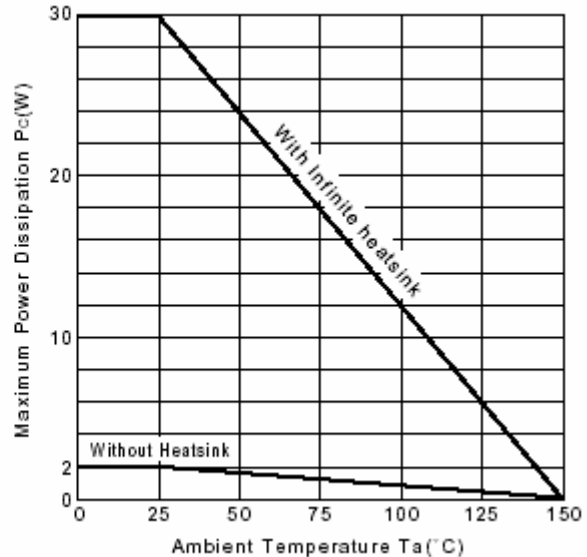

Fig.6  $P_c$ - $T_a$  Derating

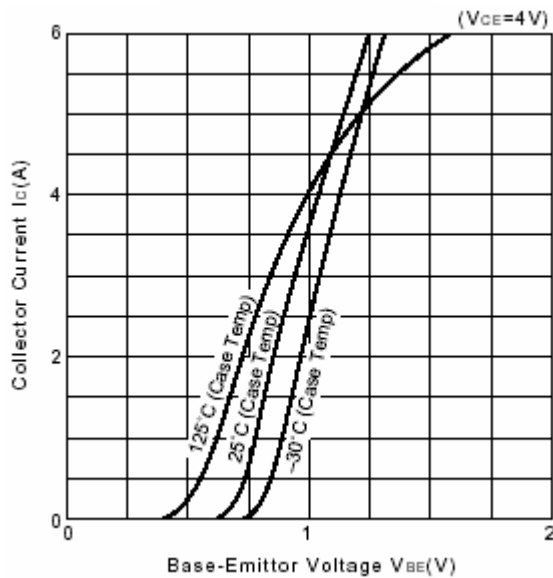

Fig.7  $I_c$ - $V_{BE}$

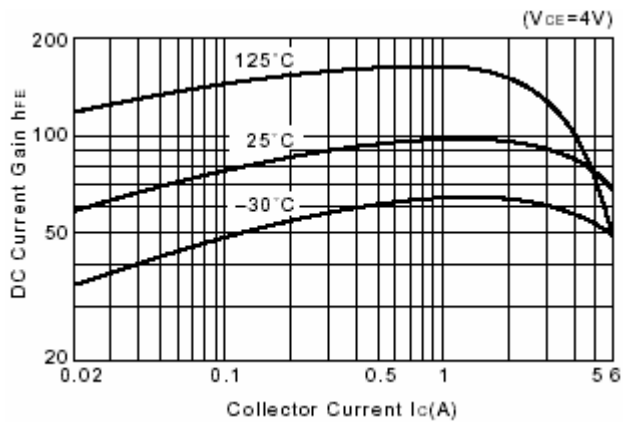

Fig.8 DC current Gain