

Silicon PNP Power Transistors

2SA1096 2SA1096A

DESCRIPTION

- With TO-126 package
- Complement to type 2SC2497/2SC2497A

APPLICATIONS

- For low-frequency power amplification

PINNING

PIN	DESCRIPTION
1	Emitter
2	Collector;connected to mounting base
3	Base

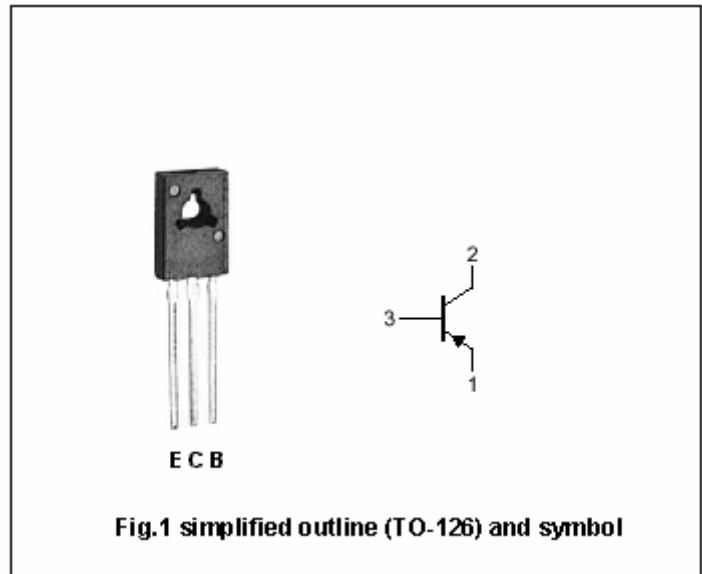

Absolute maximum ratings(Ta=25°C)

SYMBOL	PARAMETER	CONDITIONS	VALUE	UNIT
V _{CB0}	Collector-base voltage	Open emitter	-70	V
V _{CEO}	Collector- emitter voltage	2SA1096	-50	V
		2SA1096A	-60	
V _{EBO}	Emitter-base voltage	Open collector	-5	V
I _C	Collector current		-2	A
I _{CM}	Collector current-peak		-3	A
P _D	Total power dissipation	T _C =25°C	1.2 ^{*1}	W
			5 ^{*2}	
T _j	Junction temperature		150	°C
T _{stg}	Storage temperature		-55~+150	°C

Note) *1: Without heat sink

*2: With a 100 × 100 × 2 mm A1 heat sink

Silicon PNP Power Transistors

2SA1096 2SA1096A

CHARACTERISTICS

T_j=25°C unless otherwise specified

SYMBOL	PARAMETER	CONDITIONS	MIN	TYP.	MAX	UNIT	
V _{(BR)CEO}	Collector-emitter breakdown voltage	2SA1096	I _C =-2mA ; I _B =0	-50			V
		2SA1096A		-60			
V _{(BR)CBO}	Collector-base breakdown voltage	I _C =-1mA ; I _E =0	-70			V	
V _{CEsat}	Collector-emitter saturation voltage	I _C =-1.5A ; I _B =-0.15A			-1.0	V	
V _{BEsat}	Base-emitter saturation voltage	I _C =-1.5A ; I _B =-0.15A			-1.5	V	
I _{CEO}	Collector cut-off current	V _{CE} =-10V ; I _B =0			-1	μ A	
I _{CBO}	Collector cut-off current	V _{CB} =-20V ; I _E =0			-100	μ A	
I _{EBO}	Emitter cut-off current	V _{EB} =-5V ; I _C =0			-10	μ A	
h _{FE}	DC current gain	I _C =-1A ; V _{CE} =-5V	80		220		
C _{OB}	Output capacitance	I _E =0 ; V _{CB} =-20V, f=1MHz		55		pF	
f _T	Transition frequency	I _E =-0.5A ; V _{CB} =-5V, f=200MHz		150		MHz	

◆ h_{FE} Classifications

Q	R
80-160	120-220

Silicon PNP Power Transistors

2SA1096 2SA1096A

PACKAGE OUTLINE

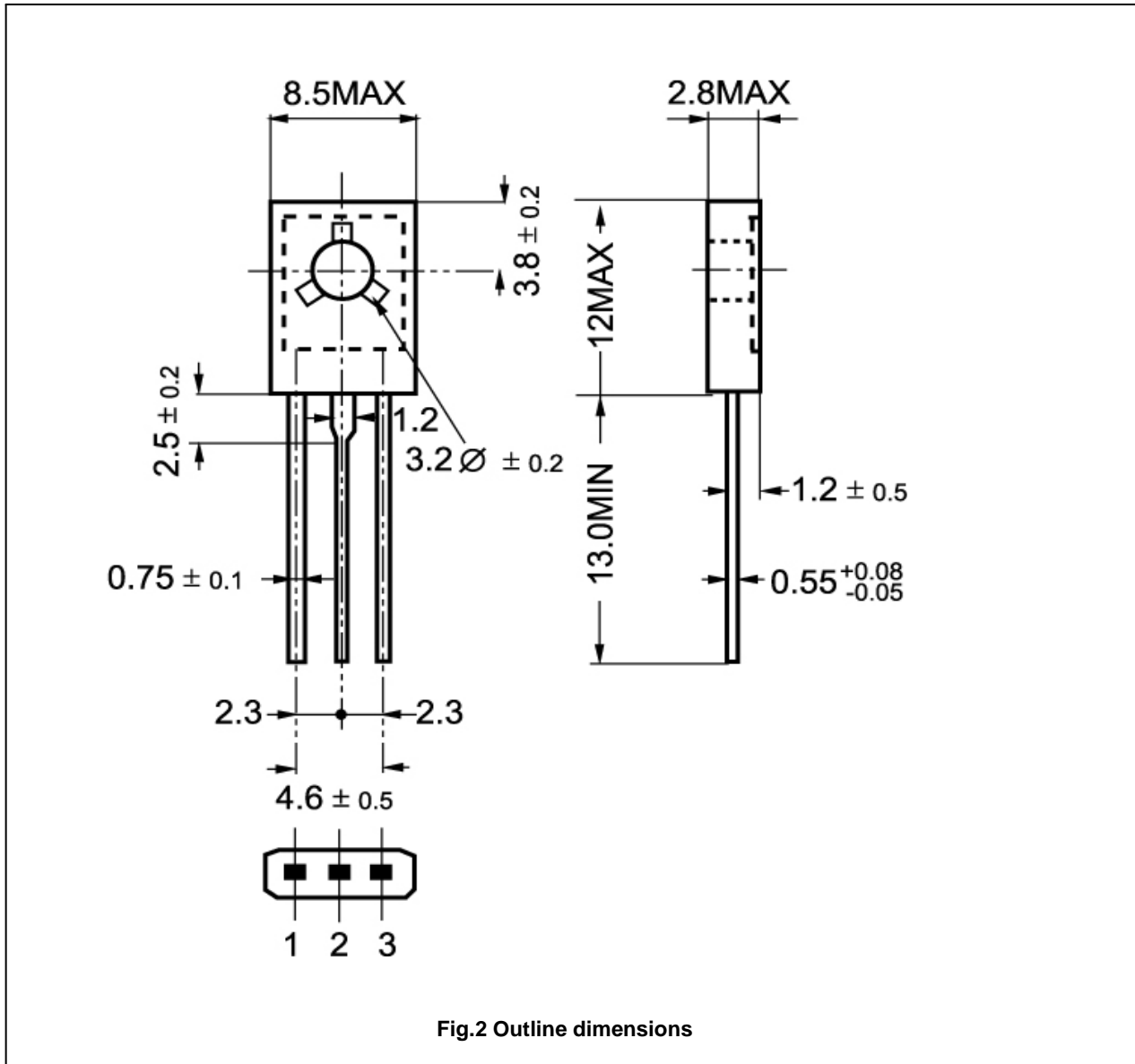

Silicon PNP Power Transistors

2SA1096 2SA1096A

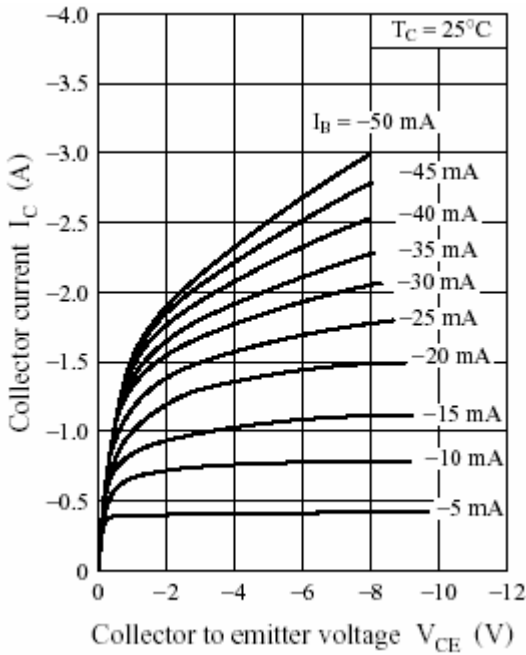

Fig.3 Static Characteristic

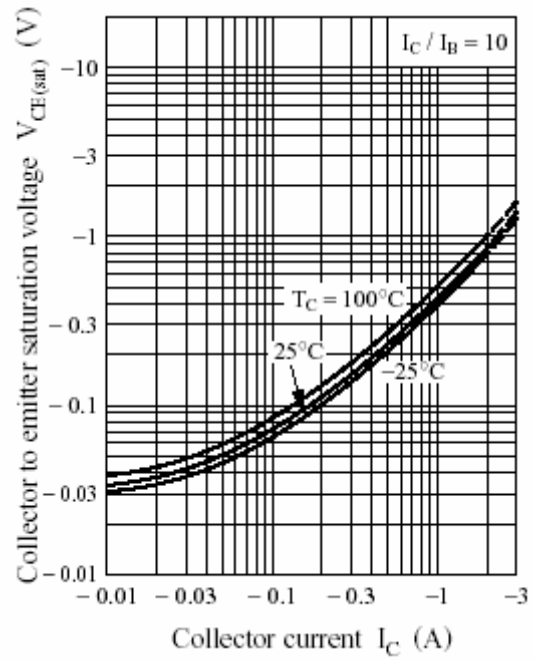

Fig.4 Collector-Emitter Saturation Voltage

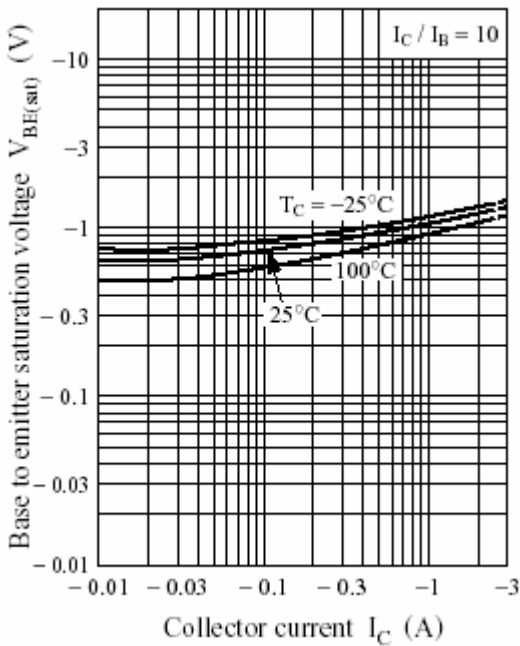

Fig.5 Base-Emitter Saturation Voltage

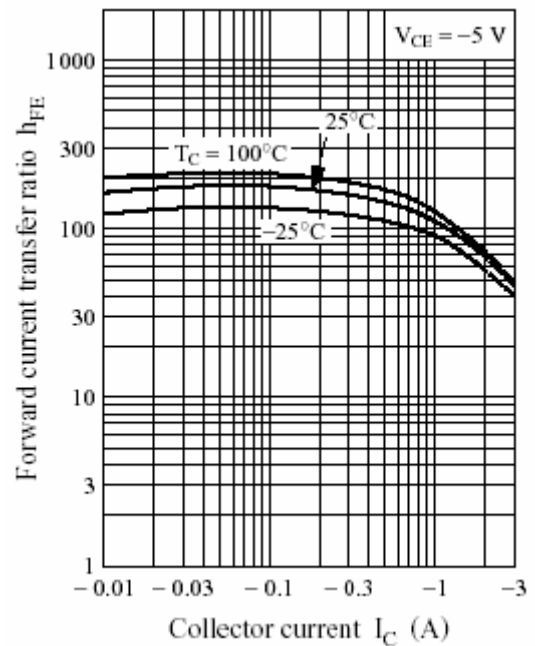

Fig.6 DC current Gain

Silicon PNP Power Transistors

2SA1096 2SA1096A

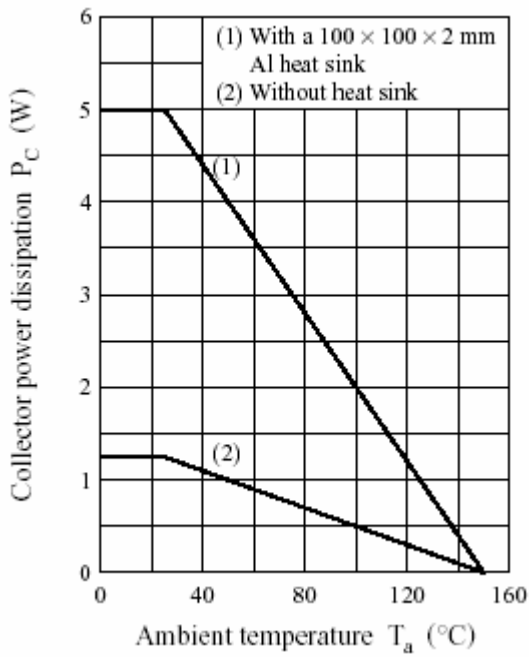

Fig.7 Power Derating

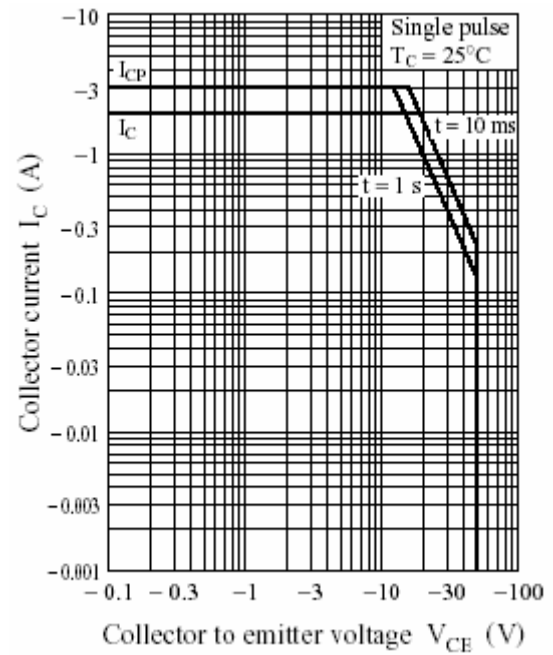

Fig.8 Safe Operating Area