

Micro-D Filter Connectors Right Angle Printed Circuit Board



Right Angle Board Mount Filtered Micro-D's. These connectors feature low-pass EMI filtering in a right angle header for PCB termination.

Key Features include gold plated TwistPin contacts, machined aluminum shells, and either Pi or C filter elements. These environmentally sealed connectors are designed to meet the requirements of MIL-DTL-83513.

.100" x .100" Board Spacing – These connectors are similar to “CBR” style Micro-D's and share the same board footprint, allowing retrofit to existing boards.

HOW TO ORDER MICRO-D FILTERED RIGHT ANGLE PCB

F

Series	Shell Finish	Number of Contacts	Contact Type	Filter Type	Filter Class	Hardware Option	Tail Length				
240-034	1 – Cadmium	9	P Pin	C C Filter	A	NN – No Jackpost, No Threaded Insert	.080				
	2 – Nickel	15			B	PN – Jackpost, No Threaded Insert	.110				
	4 – Black Anodize	21			C	NU – Threaded Insert Only, No Jackposts	.125				
		25	S Socket	P Pi Filter	D	PU – Jackpost and Threaded Insert	.150				
	5 – Gold	31			E	Rear Panel Jackposts With Threaded Inserts	.190				
	6 – Chem Film	37			F		R6U – 0.125" (3.2) Panel R5U – 0.094" (2.4) Panel R4U – 0.062" (1.6) Panel R3U – 0.047" (1.2) Panel R2U – 0.031" (0.8) Panel	.250			
								Length in Inches			
	Sample Part Number										
	240-034	– 2	– 37	S	P	E	PU	– .080			

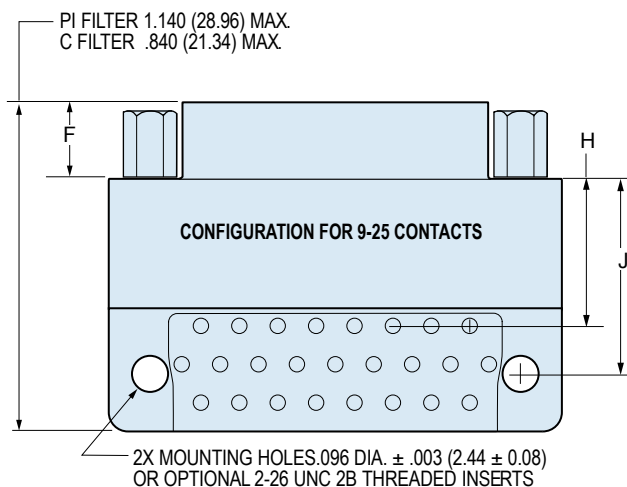
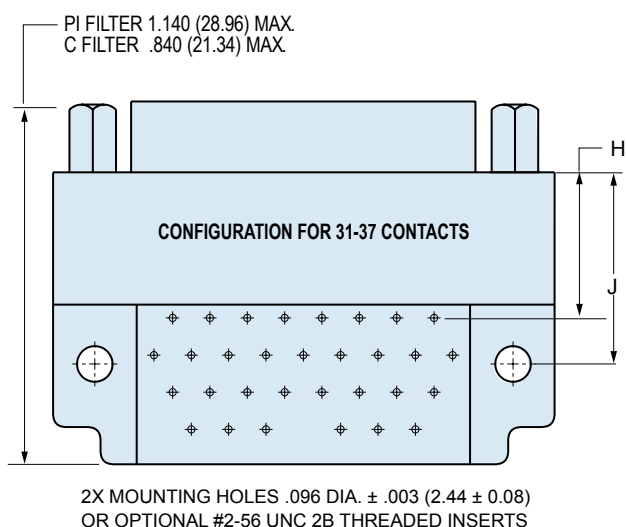
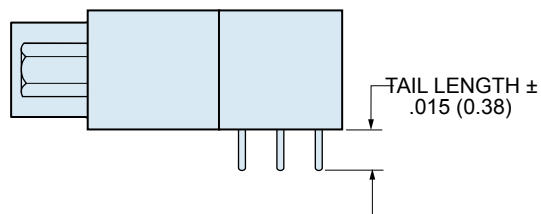
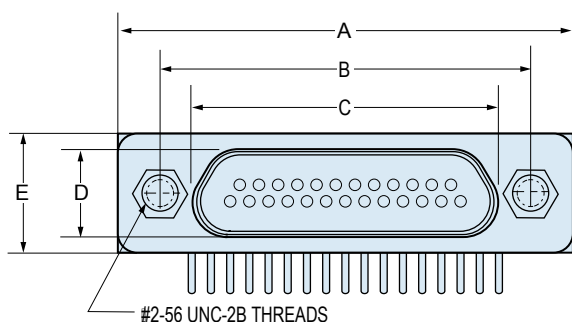

F

DIMENSIONS

Layout	A Max.		B		C Max.		D Max.		E Max.		F		G Max.		C Filter				Pi Filter			
	In.	mm.	In.	mm.	In.	mm.	In.	mm.	In.	mm.	In.	mm.	In.	mm.	In.	mm.	In.	mm.	In.	mm.	In.	mm.
			±.003	±0.08							±.004	±0.10			±.010	±0.25	±.010	±0.25	±.010	±0.25	±.010	±0.25
9P	.785	19.94	.565	14.35	.333	8.46	.184	4.67	.310	7.87	.183	4.65	.420	10.67	.440	11.18	.460	11.68	.740	18.80	.760	19.30
9S	.785	19.94	.565	14.35	.400	10.16	.250	6.35	.310	7.87	.195	4.95	.420	10.67	.440	11.18	.460	11.68	.740	18.80	.760	19.30
15P	.935	23.75	.715	18.16	.483	12.27	.184	4.67	.310	7.87	.183	4.65	.420	10.67	.340	8.64	.460	11.68	.640	16.26	.760	19.30
15S	.935	23.75	.715	18.16	.551	14.00	.250	6.35	.310	7.87	.195	4.95	.420	10.67	.340	8.64	.460	11.68	.640	16.26	.760	19.30
21P	1.085	27.56	.865	21.97	.633	16.08	.184	4.67	.310	7.87	.183	4.65	.420	10.67	.340	8.64	.460	11.68	.640	16.26	.760	19.30
21S	1.085	27.56	.865	21.97	.701	17.81	.250	6.35	.310	7.87	.195	4.95	.420	10.67	.340	8.64	.460	11.68	.640	16.26	.760	19.30
25P	1.185	30.01	.965	24.51	.733	18.62	.184	4.67	.310	7.87	.183	4.65	.420	10.67	.340	8.64	.460	11.68	.640	16.26	.760	19.30
25S	1.185	30.01	.965	24.51	.801	20.35	.250	6.35	.310	7.87	.195	4.95	.420	10.67	.340	8.64	.460	11.68	.640	16.26	.760	19.30
31P	1.335	33.91	1.115	28.32	.883	22.43	.184	4.67	.310	7.87	.183	4.65	.520	13.21	.340	8.64	.460	11.68	.640	16.26	.760	19.30
31S	1.335	33.91	1.115	28.32	.951	24.16	.250	6.35	.310	7.87	.195	4.95	.520	13.21	.340	8.64	.460	11.68	.640	16.26	.760	19.30
37P	1.485	37.72	1.265	32.13	1.033	26.24	.184	4.67	.310	7.87	.183	4.65	.520	13.21	.340	8.64	.460	11.68	.640	16.26	.760	19.30
37S	1.485	37.72	1.265	32.13	1.101	27.96	.250	6.35	.310	7.87	.195	4.95	.520	13.21	.340	8.64	.460	11.68	.640	16.26	.760	19.30

Micro-D Filter Connectors Right Angle Printed Circuit Board



MICRO-D FILTER RIGHT ANGLE PCB LAYOUTS— PIN CONNECTOR

PC Tail Diameter $.018 \pm .002$ (0.46 ± 0.05)

Contact numbers shown are for pin connectors.

Patterns shown are for connector mounting side of PC board.

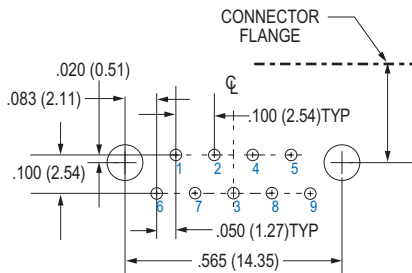

9 Contacts

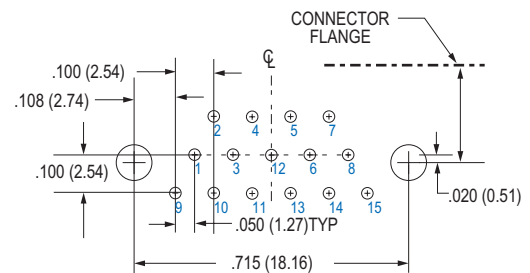

15 Contacts

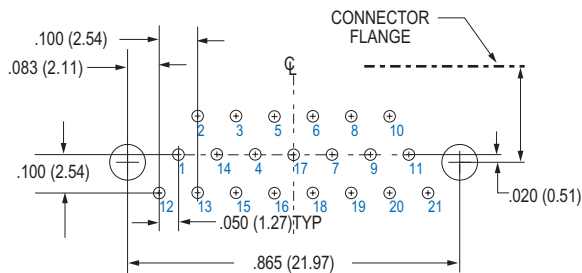

21 Contacts

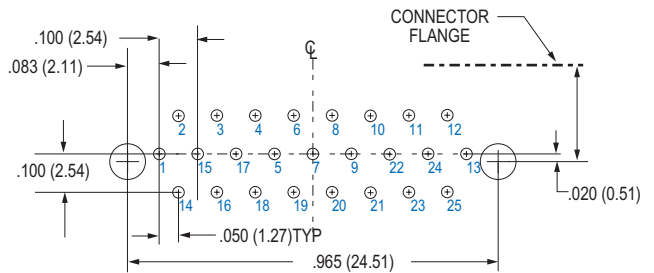

25 Contacts

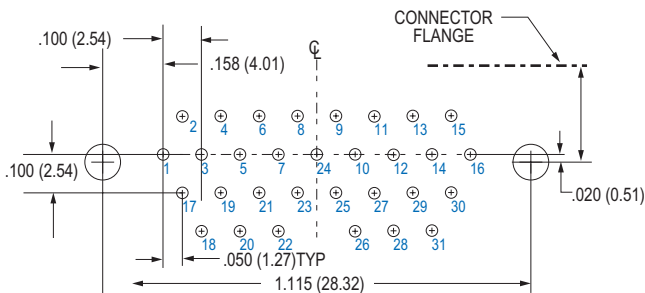

31 Contacts

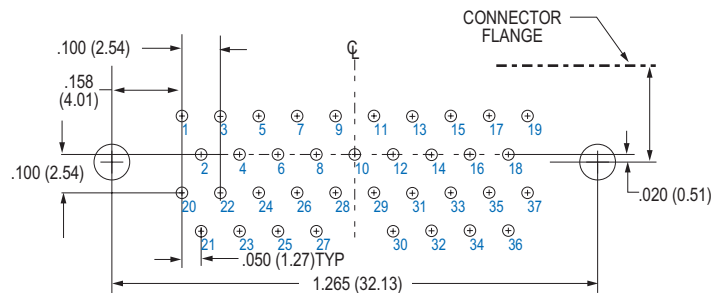

37 Contacts



MICRO-D FILTER RIGHT ANGLE PCB LAYOUTS— SOCKET CONNECTOR

PC Tail Diameter $.018 \pm .002$ (0.46 ± 0.05)

Contact numbers shown are for socket connectors.

Patterns shown are for connector mounting side of PC board.

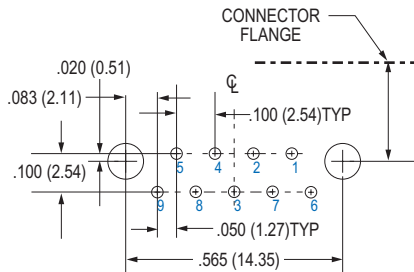

9 Contacts

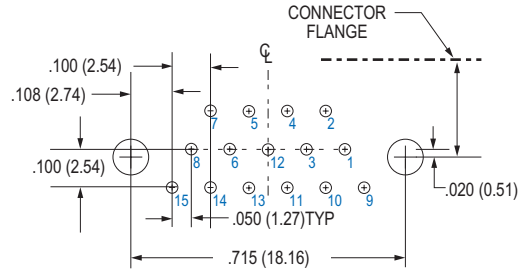

15 Contacts

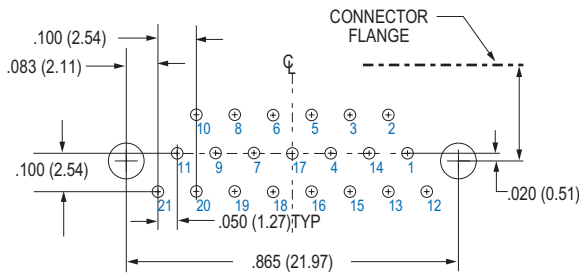

21 Contacts

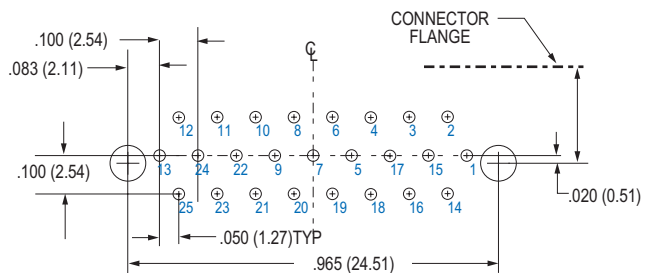

25 Contacts

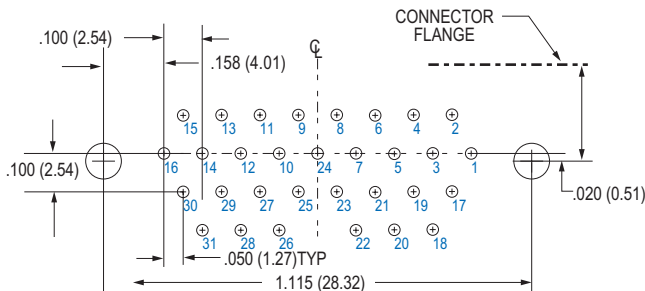

31 Contacts

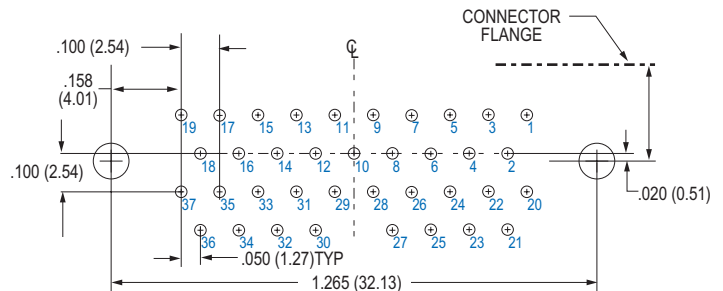

37 Contacts