

## Silicon PNP Power Transistors

2SA1771

## DESCRIPTION

- With TO-220F package
- Low collector saturation voltage
- High speed switching time

## APPLICATIONS

- High current switching

## PINNING

PIN	DESCRIPTION
1	Base
2	Collector
3	Emitter

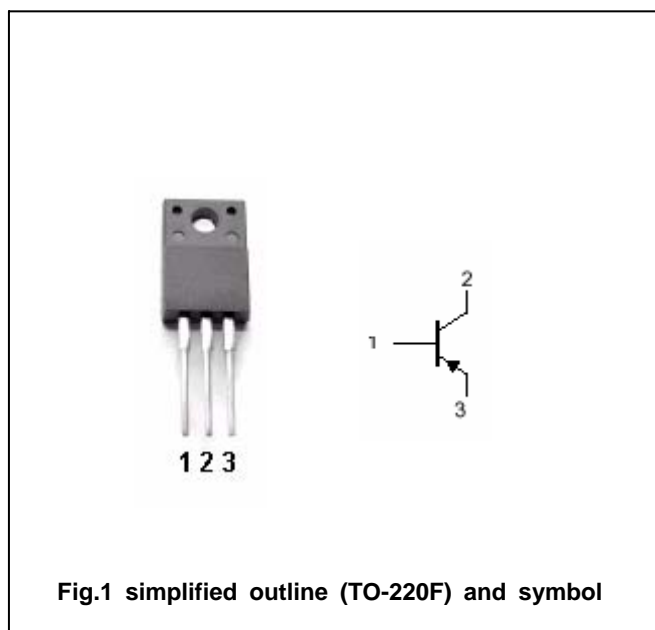

## Absolute maximum ratings (Ta=25°C)

SYMBOL	PARAMETER	CONDITIONS	MAX	UNIT
$V_{CBO}$	Collector-base voltage	Open emitter	-80	V
$V_{CEO}$	Collector-emitter voltage	Open base	-80	V
$V_{EBO}$	Emitter-base voltage	Open collector	-14	V
$I_C$	Collector current		-12	A
$I_B$	Base current		-1.2	A
$P_C$	Collector dissipation	$T_C=25^\circ\text{C}$	30	W
$T_j$	Junction temperature		150	$^\circ\text{C}$
$T_{stg}$	Storage temperature		-55~150	$^\circ\text{C}$

## Silicon PNP Power Transistors

## 2SA1771

## CHARACTERISTICS

T<sub>j</sub>=25°C unless otherwise specified

SYMBOL	PARAMETER	CONDITIONS	MIN	TYP.	MAX	UNIT
V <sub>(BR)CEO</sub>	Collector-emitter breakdown voltage	I <sub>C</sub> =-50mA ; I <sub>B</sub> =0	-80			V
V <sub>CEsat</sub>	Collector-emitter saturation voltage	I <sub>C</sub> =-6A ; I <sub>B</sub> =-0.3A			-0.4	V
V <sub>BEsat</sub>	Base-emitter saturation voltage	I <sub>C</sub> =-6A ; I <sub>B</sub> =-0.3A			-1.2	V
I <sub>CBO</sub>	Collector cut-off current	V <sub>CB</sub> =-80V ; I <sub>E</sub> =0			-10	μ A
I <sub>EBO</sub>	Emitter cut-off current	V <sub>EB</sub> =-14V ; I <sub>C</sub> =0			-10	μ A
h <sub>FE-1</sub>	DC current gain	I <sub>C</sub> =-1A ; V <sub>CE</sub> =-1V	100		320	
h <sub>FE-2</sub>	DC current gain	I <sub>C</sub> =-6A ; V <sub>CE</sub> =-1V	40			
f <sub>T</sub>	Transition frequency	I <sub>C</sub> =-1A ; V <sub>CE</sub> =-5V		50		MHz
C <sub>OB</sub>	Collector output capacitance	f=1MHz ; V <sub>CB</sub> =-10V		300		pF

t <sub>on</sub>	Turn-on time	I <sub>B1</sub> =-I <sub>B2</sub> =-0.3A ; V <sub>CC</sub> =-30V R <sub>L</sub> =5 Ω Duty cycle ≤ 1%		0.2		μ s
t <sub>s</sub>	Storage time			0.6		μ s
t <sub>f</sub>	Fall time			0.1		μ s

Silicon PNP Power Transistors

2SA1771

PACKAGE OUTLINE

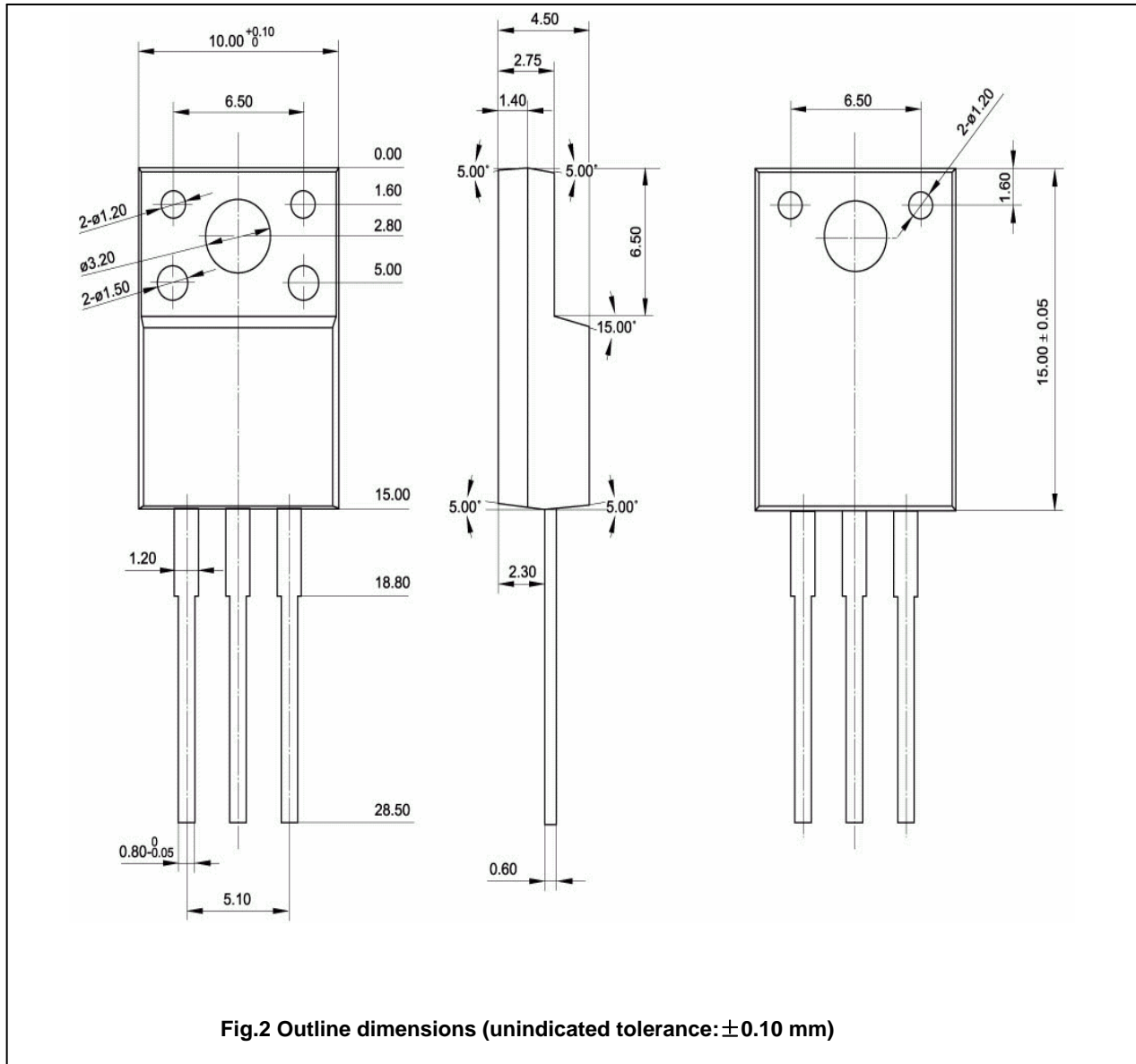

Silicon PNP Power Transistors

2SA1771

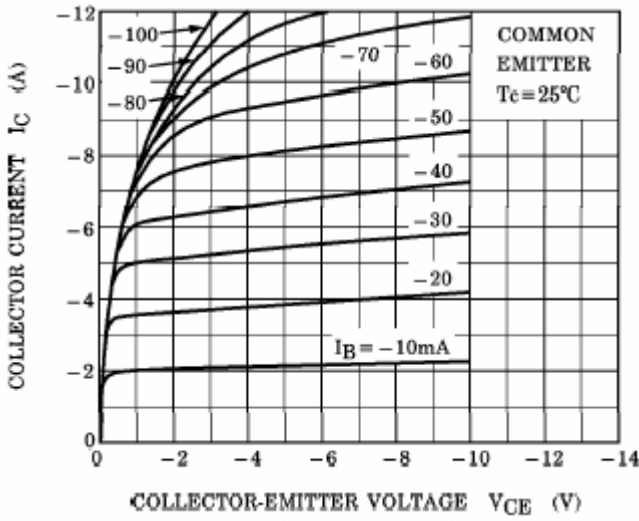

Fig.3 Static Characteristic

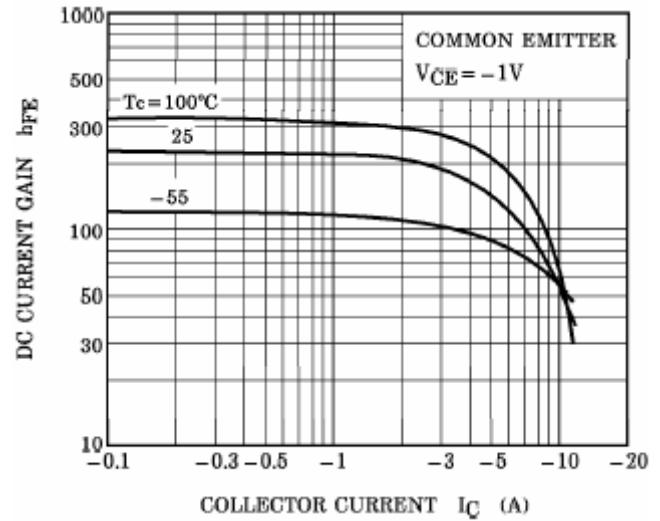

Fig.4 DC current Gain

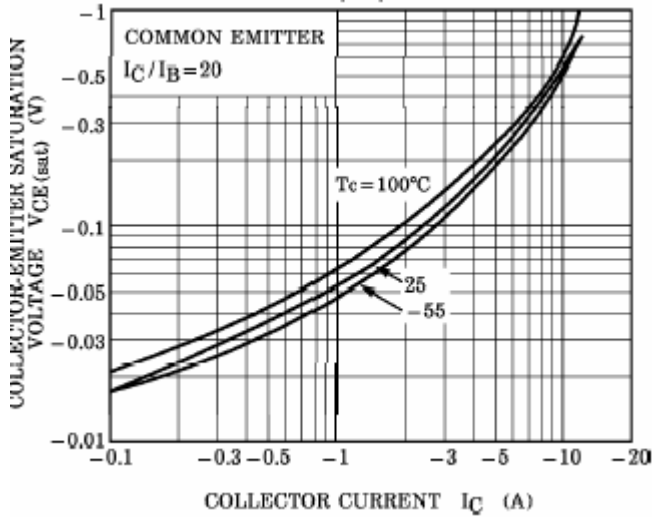

Fig.5 Collector-Emitter Saturation Voltage

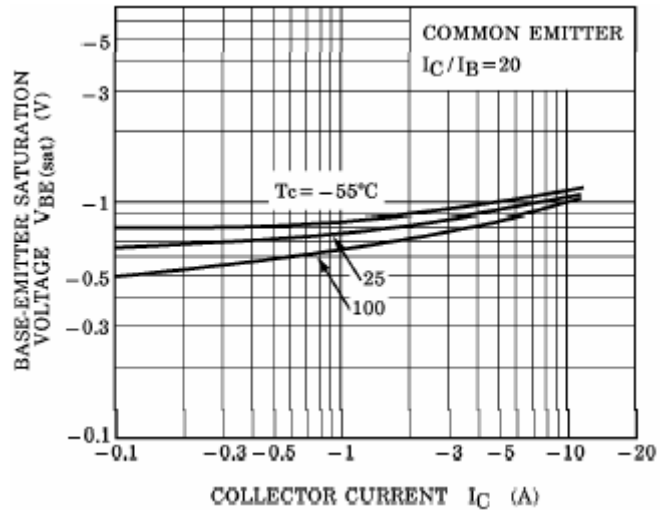

Fig.6 Base-Emitter Saturation Voltage

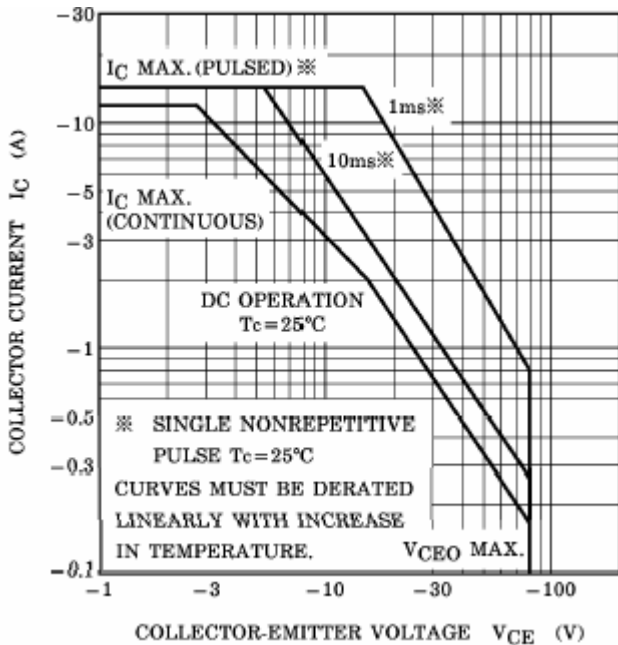

Fig.7 Safe Operating Area