

Silicon NPN Power Transistors

2SC1568

DESCRIPTION

- With TO-126 package
- Complement to type 2SA900
- Low collector saturation voltage

APPLICATIONS

- For low voltage type medium output power amplification

PINNING

PIN	DESCRIPTION
1	Emitter
2	Collector
3	Base

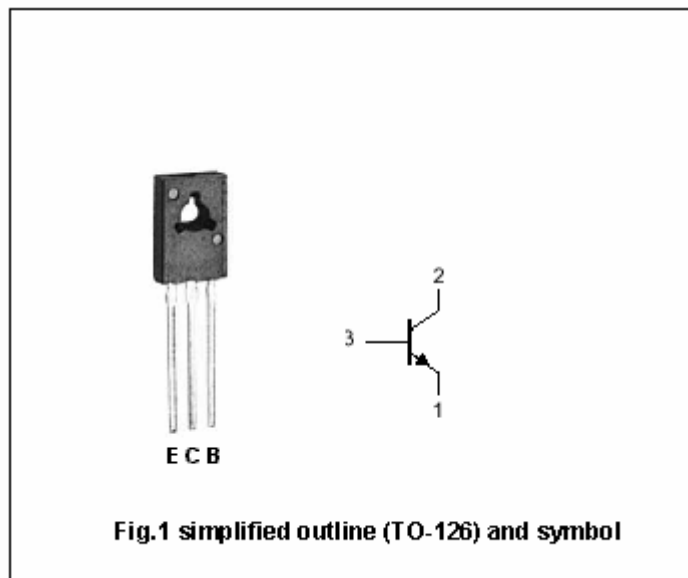
**Absolute maximum ratings (Ta=25°C)**

SYMBOL	PARAMETER	CONDITIONS	VALUE	UNIT
V _{CBO}	Collector-base voltage	Open emitter	18	V
V _{CEO}	Collector-emitter voltage	Open base	18	V
V _{EBO}	Emitter-base voltage	Open collector	5	V
I _C	Collector current		1	A
I _{CM}	Collector current-peak		2	A
P _C	Collector power dissipation	T _a =25°C	1.2	W
T _j	Junction temperature		150	°C
T _{stg}	Storage temperature		-55~150	°C

Silicon NPN Power Transistors

2SC1568

CHARACTERISTICS

T_j=25°C unless otherwise specified

SYMBOL	PARAMETER	CONDITIONS	MIN	TYP.	MAX	UNIT
V _{CEsat}	Collector-emitter saturation voltage	I _C =1A ; I _B =50m A			0.5	V
V _{BEsat}	Base-emitter saturation voltage	I _C =0.5A ; I _B =50m A			1.2	V
V _{(BR)CBO}	Collector-base breakdown voltage	I _C =10μA ; I _E =0	18			V
V _{(BR)CEO}	Collector-emitter breakdown voltage	I _C =1mA ; I _B =0	18			V
V _{(BR)EBO}	Emitter-base breakdown voltage	I _E =10μA ; I _C =0	5			V
h _{FE-1}	DC current gain	I _C =500mA ; V _{CE} =2V	90		280	
h _{FE-2}	DC current gain	I _C =1.5A ; V _{CE} =2V	50			
I _{CBO}	Collector cut-off current	V _{CB} =10V ; I _E =0			1	μA
I _{CEO}	Collector cut-off current	V _{CE} =18V ; I _B =0			10	μA
C _{OB}	Output capacitance	I _E =0 ; V _{CB} =6V ; f=1MHz		12		pF
f _T	Transition frequency	I _E =-50mA ; V _{CB} =6V ; f=200MHz		150		MHz

◆ h_{FE-1} classifications

Q	R	S
90-155	130-210	180-280

Silicon NPN Power Transistors

2SC1568

PACKAGE OUTLINE

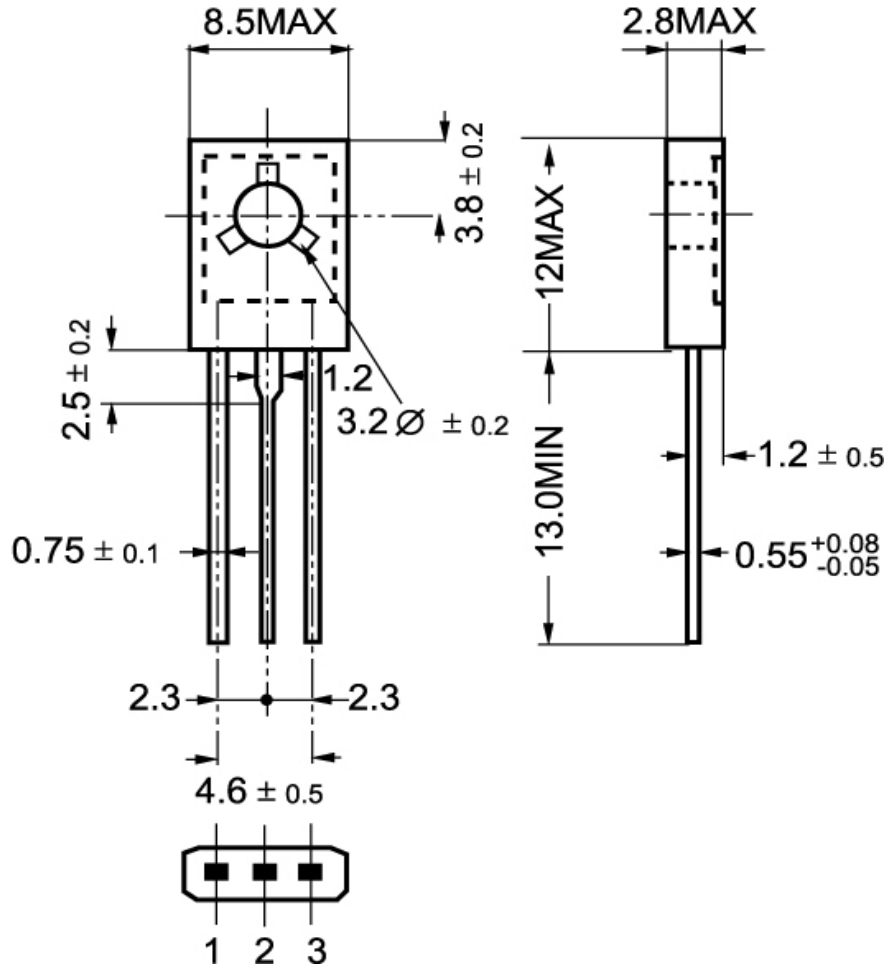

Fig.2 outline dimensions

Silicon NPN Power Transistors

2SC1568

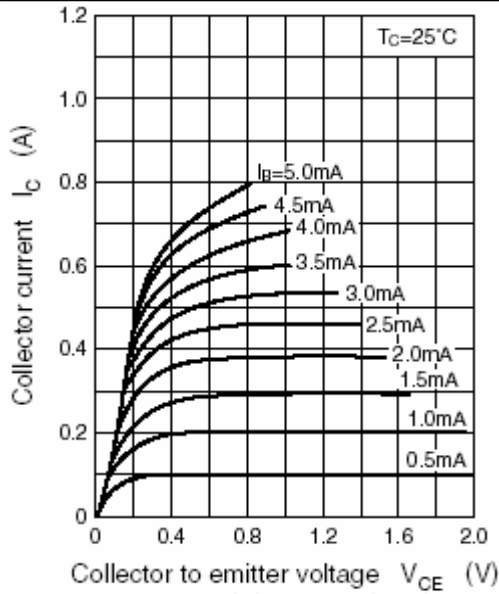

Fig.3 Static Characteristic

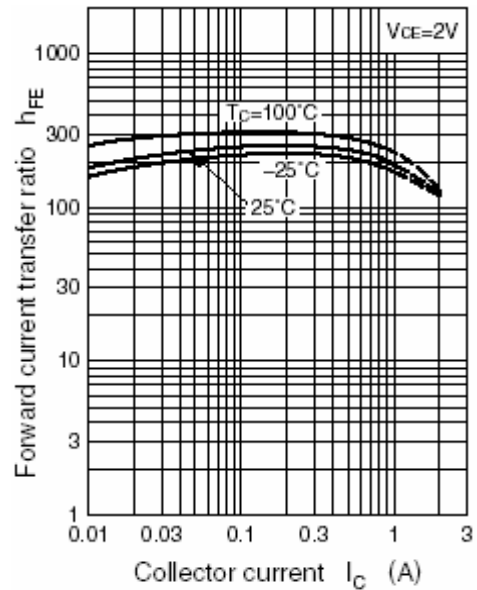

Fig.4 DC current Gain

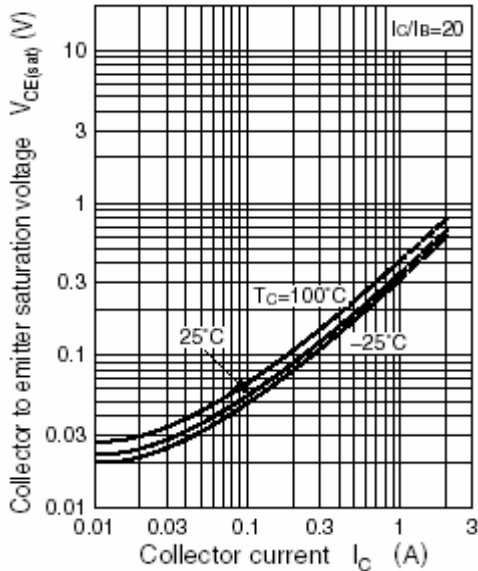

Fig.5 Collector-Emitter Saturation Voltage

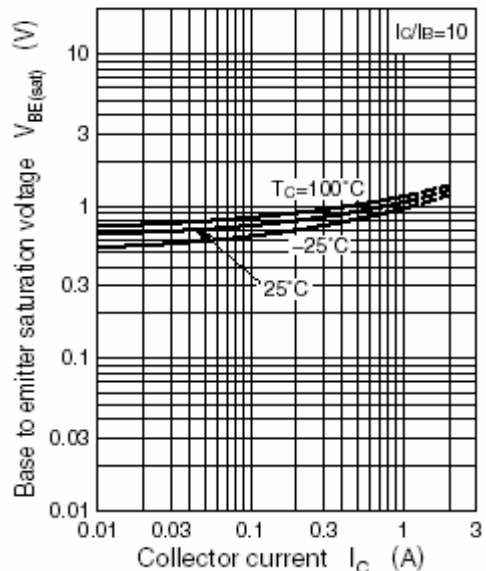

Fig.6 Base-Emitter Saturation Voltage

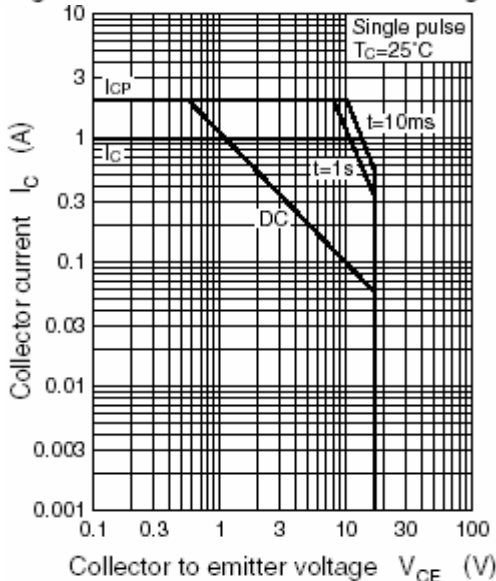

Fig.7 Safe Operating Area