

# Micro-D Filter Connectors Vertical Printed Circuit Board



**Printed Circuit Board Micro-D Filter Connectors.** These vertical mount PCB connectors are ideal for flexible circuit or motherboard applications.

**Key Features include** gold plated TwistPin contacts, machined aluminum shells, and either Pi or C filter elements. These environmentally sealed connectors are designed to meet the requirements of MIL-DTL-83513.

**Integral Board Standoffs and Pre-Tinned Tails**—These connectors are solder dipped (63/37 SnPb) and feature a full complement of mounting hardware options.

## HOW TO ORDER MICRO-D FILTER VERTICAL MOUNT PCB CONNECTORS

Series	Shell Finish	Number of Contacts	Contact Type	Filter Type	Filter Class	PC Tail Length	Hardware Option
240-031	1 – Cadmium	9	P Pin	C C Filter	A	1 – .110 Inches (2.79)	<b>NN</b> – No Jackpost, No Threaded Insert <b>PN</b> – Extended Jackpost for .062" (1.6) PCB, No Threaded Insert <b>RN</b> – Extended Jackpost for .196" (5.0) PCB, No Threaded Insert <b>NU</b> – Threaded Insert Only, No Jackposts <b>PU</b> – Short Jackpost and Threaded Insert  <b>Rear Panel Jackposts With Threaded Inserts</b> <b>R6U</b> – 0.125" (3.2) Panel <b>R5U</b> – 0.094" (2.4) Panel <b>R4U</b> – 0.062" (1.6) Panel <b>R3U</b> – 0.047" (1.2) Panel <b>R2U</b> – 0.031" (0.8) Panel  <b>JackscREW Options</b> <b>M</b> – Hex Head Jackscrews <b>S</b> – Slot Head Jackscrews
	2 – Nickel	15			B		
	4 – Black Anodize	21	S Socket	P Pi Filter	C	2 – .250 Inches (6.35)	
		25			D		
	5 – Gold	31			E		
	6 – Chem Film	37			F		
				G			
<b>Sample Part Number</b>							
240-031	2	– 25	P	C	D	1	PN

F

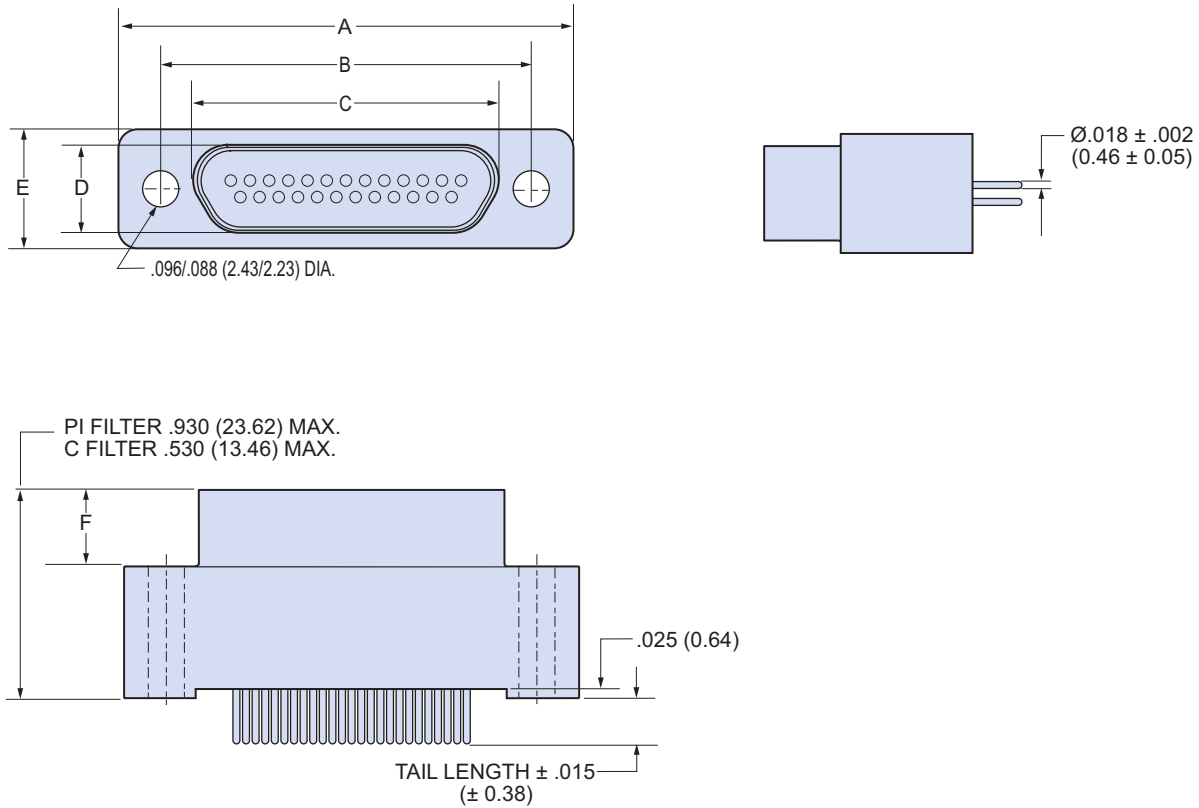

## MICRO-D FILTER VERTICAL PCB DIMENSIONS

Layout	A Max.		B		C Max.		D Max.		E Max.		F	
	In.	mm.	In. ± .003	mm. ± 0.08	In.	mm.	In.	mm.	In.	mm.	In. ± .004	mm. ± 0.10
<b>9P</b>	.785	19.94	.565	14.35	.333	8.46	.184	4.67	.310	7.87	.183	4.65
<b>9S</b>	.785	19.94	.565	14.35	.400	10.16	.250	6.35	.310	7.87	.195	4.95
<b>15P</b>	.935	23.75	.715	18.16	.483	12.27	.184	4.67	.310	7.87	.183	4.65
<b>15S</b>	.935	23.75	.715	18.16	.551	14.00	.250	6.35	.310	7.87	.195	4.95
<b>21P</b>	1.085	27.56	.865	21.97	.633	16.08	.184	4.67	.310	7.87	.183	4.65
<b>21S</b>	1.085	27.56	.865	21.97	.701	17.81	.250	6.35	.310	7.87	.195	4.95
<b>25P</b>	1.185	30.01	.965	24.51	.733	18.62	.184	4.67	.310	7.87	.183	4.65
<b>25S</b>	1.185	30.01	.965	24.51	.801	20.35	.250	6.35	.310	7.87	.195	4.95
<b>31P</b>	1.335	33.91	1.115	28.32	.883	22.43	.184	4.67	.310	7.87	.183	4.65
<b>31S</b>	1.335	33.91	1.115	28.32	.951	24.16	.250	6.35	.310	7.87	.195	4.95
<b>37P</b>	1.485	37.72	1.265	32.13	1.033	26.24	.184	4.67	.310	7.87	.183	4.65
<b>37S</b>	1.485	37.72	1.265	32.13	1.101	27.96	.250	6.35	.310	7.87	.195	4.95

MICRO-D FILTER VERTICAL PCB HARDWARE OPTIONS

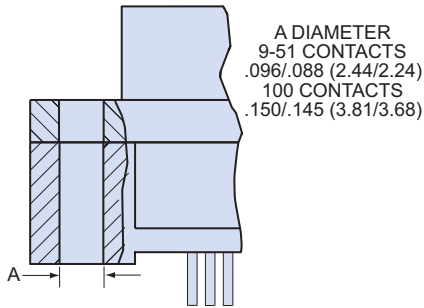

**NN Style**

Connector Supplied Without Hardware  
Thru-Hole, No Hardware



**NU Style**

Connector Supplied With Threaded Inserts



**PU Style**

Jackpost with Threaded Insert



**RU Style**

Rear Panel Jackpost with Threaded Insert



**Extended Jackpost**  
**PN Style for .062" PCB**  
**RN Style for .196" PCB**

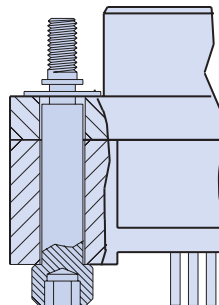

**M Style**

Hex Head Jackscrew with E-Ring



**S Style**

Slot Head Jackscrew with E-Ring

F

## MICRO-D FILTER VERTICAL PCB LAYOUTS— PIN CONNECTOR SHOWN

PC Tail Diameter  $.018 \pm .002$  ( $0.46 \pm 0.05$ )

Contact numbers shown are for pin connectors. Reverse for socket.

Patterns shown are for connector mounting side of PC board.



**9 Contacts**

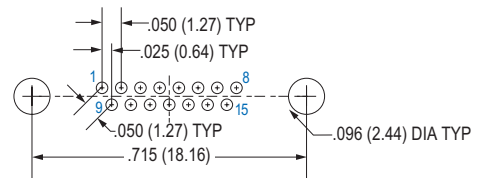

**15 Contacts**

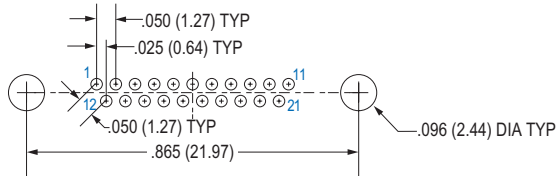

**21 Contacts**

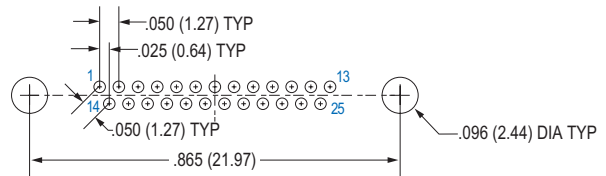

**25 Contacts**

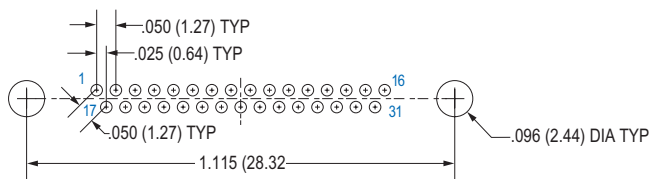

**31 Contacts**

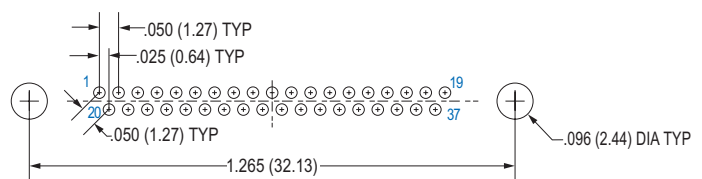

**37 Contacts**