

# 2N3055A (NPN), MJ15015 (NPN), MJ15016 (PNP)

MJ15015 and MJ15016 are Preferred Devices

## Complementary Silicon High-Power Transistors

These PowerBase™ complementary transistors are designed for high power audio, stepping motor and other linear applications. These devices can also be used in power switching circuits such as relay or solenoid drivers, dc-to-dc converters, inverters, or for inductive loads requiring higher safe operating area than the 2N3055.

### Features

- Current-Gain – Bandwidth-Product @  $I_C = 1.0 \text{ A dc}$   
 $f_T = 0.8 \text{ MHz (Min) – NPN}$   
 $= 2.2 \text{ MHz (Min) – PNP}$
- Safe Operating Area – Rated to 60 V and 120 V, Respectively
- Pb-Free Packages are Available\*

### MAXIMUM RATINGS (Note 1)

Rating	Symbol	Value	Unit
Collector-Emitter Voltage 2N3055A MJ15015, MJ15016	$V_{CEO}$	60 120	Vdc
Collector-Base Voltage 2N3055A MJ15015, MJ15016	$V_{CBO}$	100 200	Vdc
Collector-Emitter Voltage Base Reversed Biased 2N3055A MJ15015, MJ15016	$V_{CEV}$	100 200	Vdc
Emitter-Base Voltage	$V_{EBO}$	7.0	Vdc
Collector Current – Continuous	$I_C$	15	A dc
Base Current	$I_B$	7.0	A dc
Total Device Dissipation @ $T_C = 25^\circ\text{C}$ Derate above $25^\circ\text{C}$ 2N3055A	$P_D$	115 0.65	W W/ $^\circ\text{C}$
Total Device Dissipation @ $T_C = 25^\circ\text{C}$ Derate above $25^\circ\text{C}$ MJ15015, MJ15016		180 1.03	
Operating and Storage Junction Temperature Range	$T_J, T_{stg}$	-65 to +200	$^\circ\text{C}$

### THERMAL CHARACTERISTICS

Characteristics	Symbol	Max	Max	Unit
Thermal Resistance, Junction-to-Case	$R_{\theta JC}$	1.52	0.98	$^\circ\text{C/W}$

Stresses exceeding Maximum Ratings may damage the device. Maximum Ratings are stress ratings only. Functional operation above the Recommended Operating Conditions is not implied. Extended exposure to stresses above the Recommended Operating Conditions may affect device reliability.

1. Indicates JEDEC Registered Data. (2N3055A)

\*For additional information on our Pb-Free strategy and soldering details, please download the ON Semiconductor Soldering and Mounting Techniques Reference Manual, SOLDERRM/D.



ON Semiconductor®

<http://onsemi.com>

**15 AMPERE  
COMPLEMENTARY SILICON  
POWER TRANSISTORS  
60, 120 VOLTS – 115, 180 WATTS**

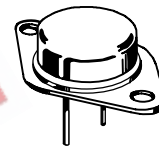

TO-204AA (TO-3)  
CASE 1-07  
STYLE 1

### MARKING DIAGRAMS



2N3055A = Device Code

MJ1501x = Device Code

x = 5 or 6

G = Pb-Free Package

A = Assembly Location

Y = Year

WW = Work Week

MEX = Country of Origin

### ORDERING INFORMATION

See detailed ordering and shipping information in the package dimensions section on page 5 of this data sheet.

Preferred devices are recommended choices for future use and best overall value.

## 2N3055A (NPN), MJ15015 (NPN), MJ15016 (PNP)

### ELECTRICAL CHARACTERISTICS ( $T_C = 25^\circ\text{C}$ unless otherwise noted)

Characteristic	Symbol	Min	Max	Unit
----------------	--------	-----	-----	------

#### OFF CHARACTERISTICS (Note 2)

Collector–Emitter Sustaining Voltage (Note 3) ( $I_C = 200\text{ mA}$ , $I_B = 0$ )	2N3055A MJ15015, MJ15016	$V_{CEO(sus)}$	60 120	– –	Vdc
Collector Cutoff Current ( $V_{CE} = 30\text{ Vdc}$ , $V_{BE(off)} = 0\text{ Vdc}$ ) ( $V_{CE} = 60\text{ Vdc}$ , $V_{BE(off)} = 0\text{ Vdc}$ )	2N3055A MJ15015, MJ15016	$I_{CEO}$	– –	0.7 0.1	mA
Collector Cutoff Current (Note 3) ( $V_{CEV} = \text{Rated Value}$ , $V_{BE(off)} = 1.5\text{ Vdc}$ )	2N3055A MJ15015, MJ15016	$I_{CEV}$	– –	5.0 1.0	mA
Collector Cutoff Current ( $V_{CEV} = \text{Rated Value}$ , $V_{BE(off)} = 1.5\text{ Vdc}$ , $T_C = 150^\circ\text{C}$ )	2N3055A MJ15015, MJ15016	$I_{CEV}$	– –	30 6.0	mA
Emitter Cutoff Current ( $V_{EB} = 7.0\text{ Vdc}$ , $I_C = 0$ )	2N3055A MJ15015, MJ15016	$I_{EBO}$	– –	5.0 0.2	mA

#### SECOND BREAKDOWN (Note 3)

Second Breakdown Collector Current with Base Forward Biased ( $t = 0.5\text{ s}$ non-repetitive) ( $V_{CE} = 60\text{ Vdc}$ )	2N3055A MJ15015, MJ15016	$I_{S/b}$	1.95 3.0	– –	A
---	-----------------------------	-----------	-------------	--------	---

#### ON CHARACTERISTICS (Note 2 and 3)

DC Current Gain ( $I_C = 4.0\text{ A}$ , $V_{CE} = 2.0\text{ Vdc}$ ) ( $I_C = 4.0\text{ A}$ , $V_{CE} = 4.0\text{ Vdc}$ ) ( $I_C = 10\text{ A}$ , $V_{CE} = 4.0\text{ Vdc}$ )	$h_{FE}$	10 20 5.0	70 70 –	–
Collector–Emitter Saturation Voltage ( $I_C = 4.0\text{ A}$ , $I_B = 400\text{ mA}$ ) ( $I_C = 10\text{ A}$ , $I_B = 3.3\text{ A}$ ) ( $I_C = 15\text{ A}$ , $I_B = 7.0\text{ A}$ )	$V_{CE(sat)}$	– – –	1.1 3.0 5.0	Vdc
Base–Emitter On Voltage ( $I_C = 4.0\text{ A}$ , $V_{CE} = 4.0\text{ Vdc}$ )	$V_{BE(on)}$	0.7	1.8	Vdc

#### DYNAMIC CHARACTERISTICS (Note 3)

Current–Gain – Bandwidth Product ( $I_C = 1.0\text{ A}$ , $V_{CE} = 4.0\text{ Vdc}$ , $f = 1.0\text{ MHz}$ )	2N3055A, MJ15015 MJ15016	$f_T$	0.8 2.2	6.0 18	MHz
Output Capacitance ( $V_{CB} = 10\text{ Vdc}$ , $I_E = 0$ , $f = 1.0\text{ MHz}$ )		$C_{ob}$	60	600	pF

#### SWITCHING CHARACTERISTICS (2N3055A only) (Note 3)

RESISTIVE LOAD					
Delay Time	( $V_{CC} = 30\text{ Vdc}$ , $I_C = 4.0\text{ A}$ , $I_{B1} = I_{B2} = 0.4\text{ A}$ , $t_p = 25\text{ }\mu\text{s}$ Duty Cycle $\leq 2\%$ )	$t_d$	–	0.5	$\mu\text{s}$
Rise Time		$t_r$	–	4.0	$\mu\text{s}$
Storage Time		$t_s$	–	3.0	$\mu\text{s}$
Fall Time		$t_f$	–	6.0	$\mu\text{s}$

2. Pulse Test: Pulse Width = 300  $\mu\text{s}$ , Duty Cycle  $\leq 2\%$ .

3. Indicates JEDEC Registered Data. (2N3055A)

## 2N3055A (NPN), MJ15015 (NPN), MJ15016 (PNP)

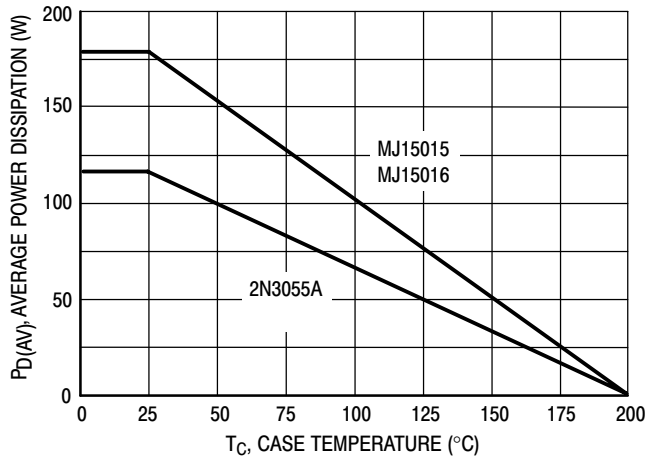

Figure 1. Power Derating

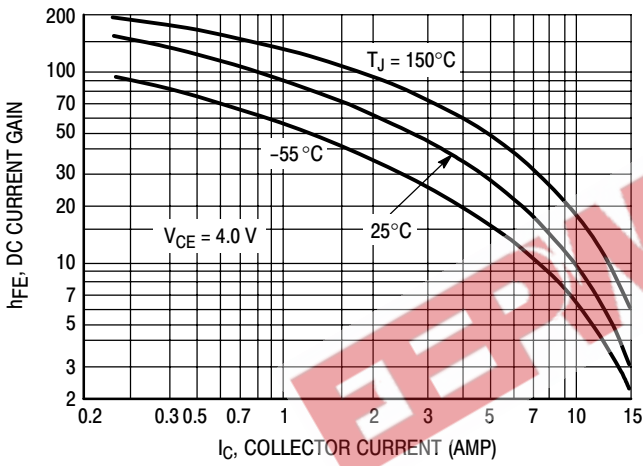

Figure 2. DC Current Gain

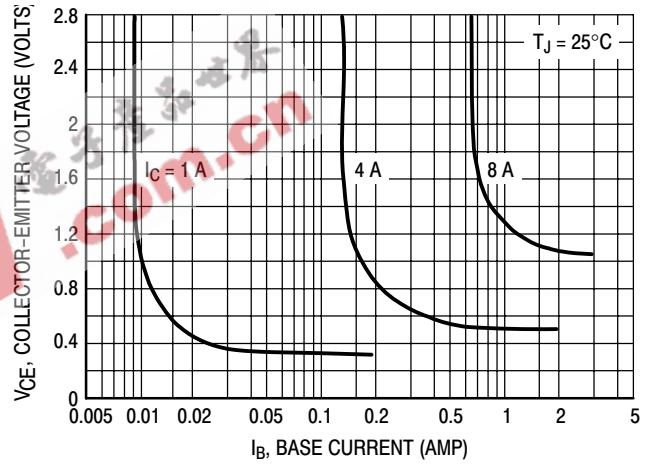

Figure 3. Collector Saturation Region

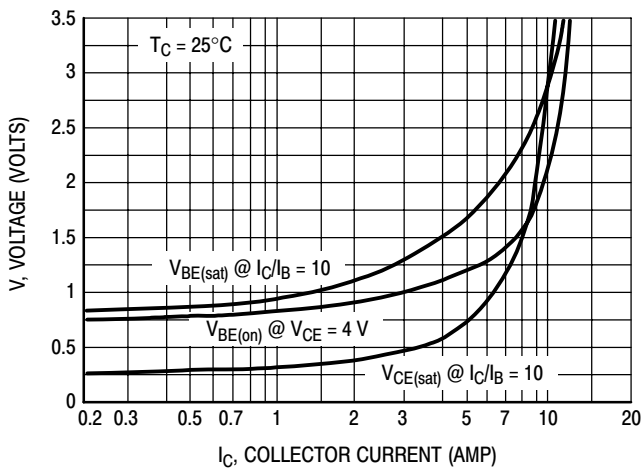

Figure 4. "On" Voltages

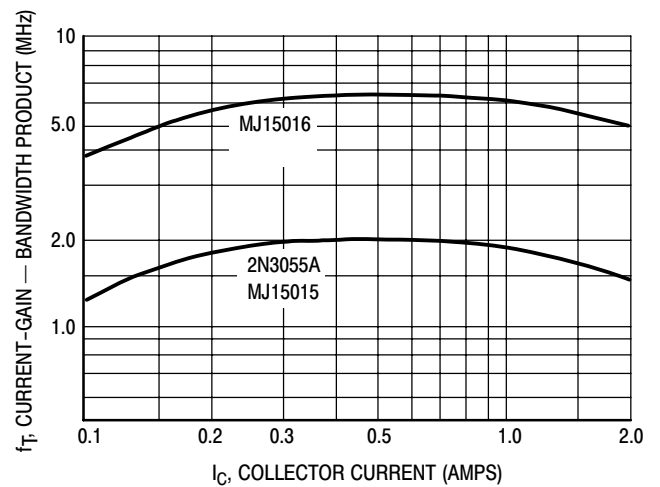
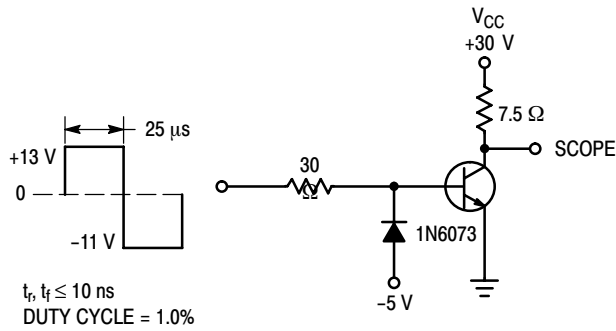
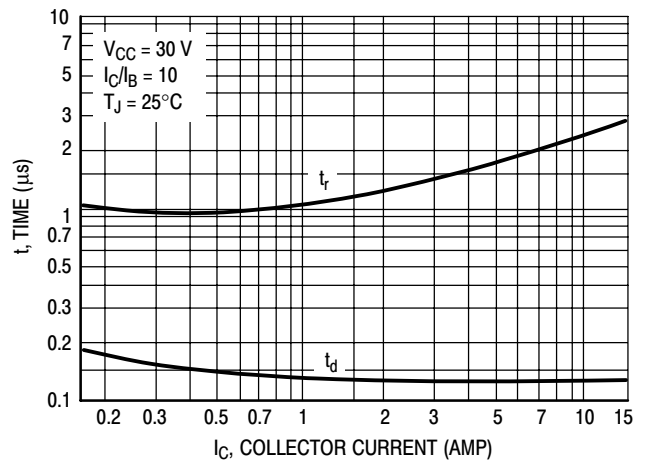

Figure 5. Current-Gain — Bandwidth Product

## 2N3055A (NPN), MJ15015 (NPN), MJ15016 (PNP)



**Figure 6. Switching Times Test Circuit  
(Circuit shown is for NPN)**



**Figure 7. Turn-On Time**

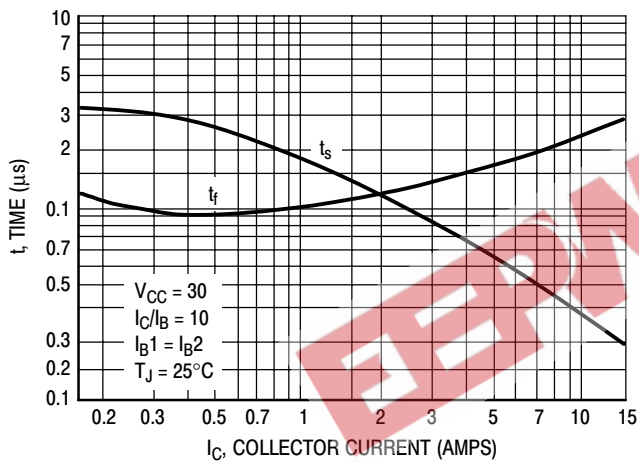

**Figure 8. Turn-Off Times**

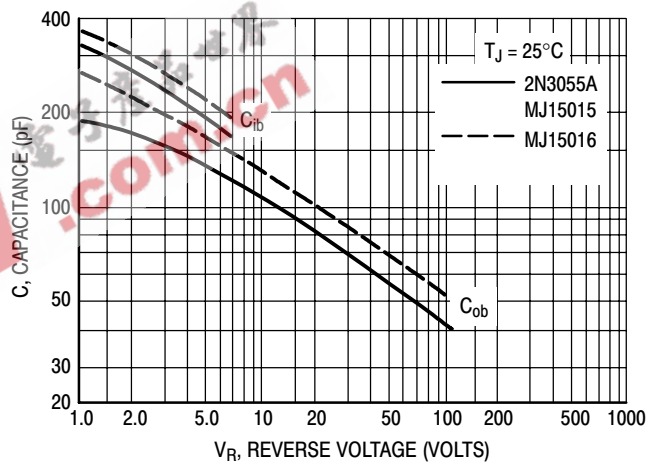

**Figure 9. Capacitances**

## 2N3055A (NPN), MJ15015 (NPN), MJ15016 (PNP)

### COLLECTOR CUT-OFF REGION

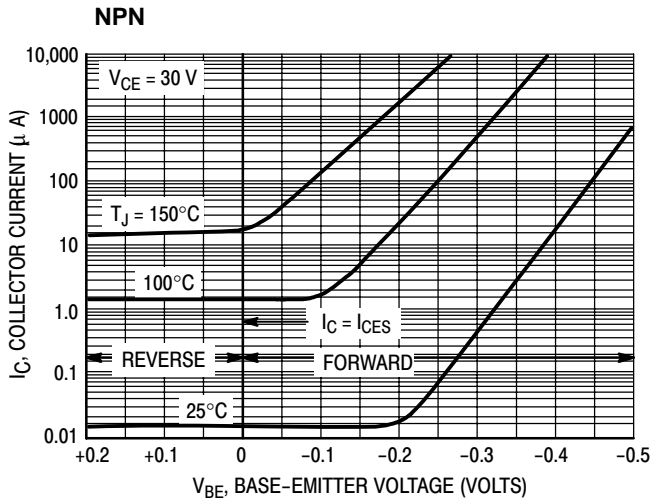

Figure 10. 2N3055A, MJ15015

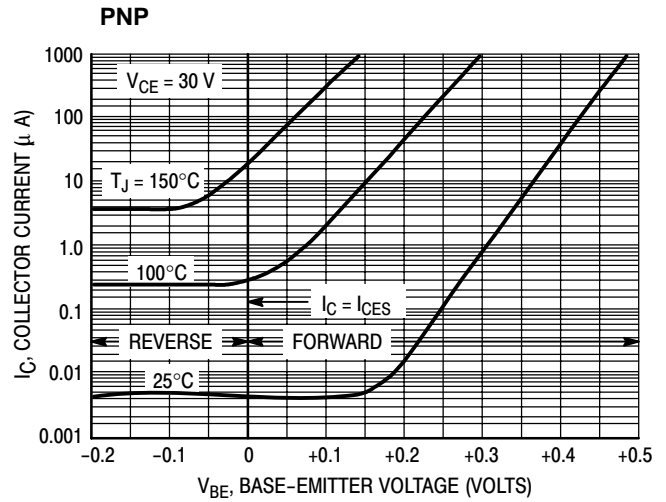

Figure 11. MJ15016

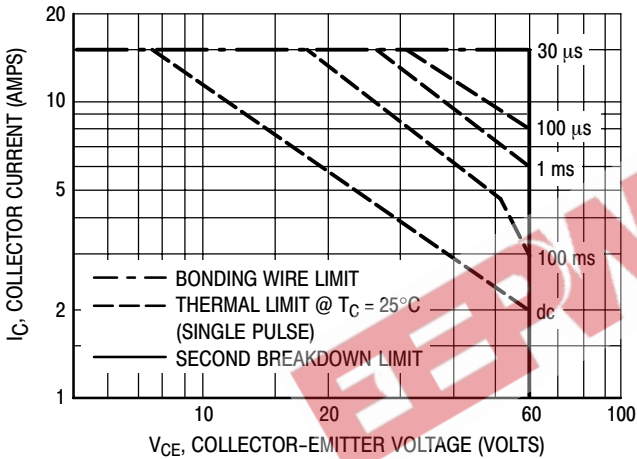

Figure 12. Forward Bias Safe Operating Area  
2N3055A

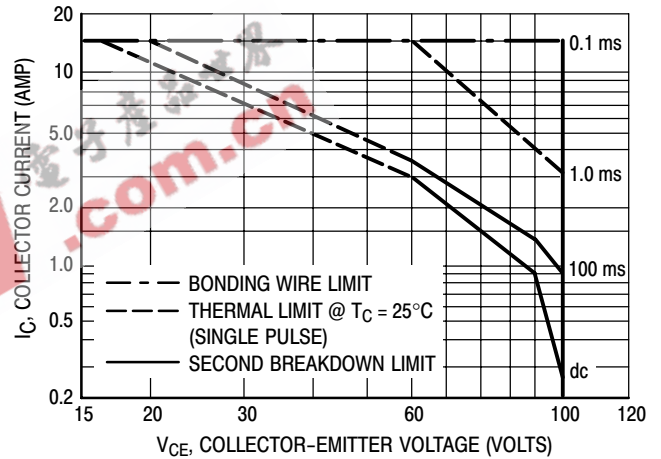

Figure 13. Forward Bias Safe Operating Area  
MJ15015, MJ15016

There are two limitations on the power handling ability of a transistor: average junction temperature and second breakdown. Safe Operating area curves indicate  $I_C - V_{CE}$  limits of the transistor that must be observed for reliable operation; i.e., the transistor must not be subjected to greater dissipation than the curves indicate.

The data of Figures 12 and 13 is based on  $T_C = 25^\circ\text{C}$ ;  $T_{J(pk)}$  is variable depending on power level. Second breakdown pulse limits are valid for duty cycles to 10% but must be derated for temperature according to Figure 1.

#### ORDERING INFORMATION

Device	Package	Shipping
2N3055A	TO-204	100 Units / Tray
2N3055AG	TO-204 (Pb-Free)	
MJ15015	TO-204	100 Units / Tray
MJ15015G	TO-204 (Pb-Free)	
MJ15016	TO-204	
MJ15016G	TO-204 (Pb-Free)	

# 2N3055A (NPN), MJ15015 (NPN), MJ15016 (PNP)

## PACKAGE DIMENSIONS

TO-204 (TO-3)  
CASE 1-07  
ISSUE Z

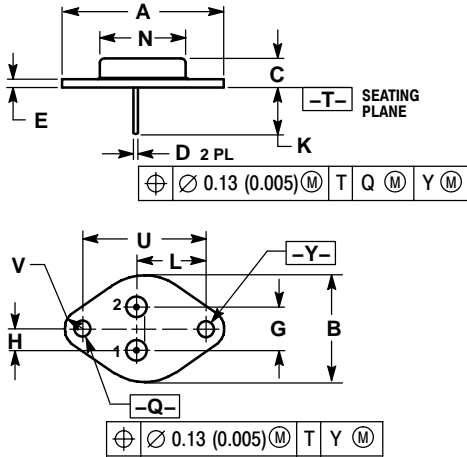

### NOTES:

1. DIMENSIONING AND TOLERANCING PER ANSI Y14.5M, 1982.
2. CONTROLLING DIMENSION: INCH.
3. ALL RULES AND NOTES ASSOCIATED WITH REFERENCED TO-204AA OUTLINE SHALL APPLY.

DIM	INCHES		MILLIMETERS	
	MIN	MAX	MIN	MAX
A	1.550 REF		39.37 REF	
B	---	1.050	---	26.67
C	0.250	0.335	6.35	8.51
D	0.038	0.043	0.97	1.09
E	0.055	0.070	1.40	1.77
G	0.430 BSC		10.92 BSC	
H	0.215 BSC		5.46 BSC	
K	0.440	0.480	11.18	12.19
L	0.665 BSC		16.89 BSC	
N	---	0.830	---	21.08
Q	0.151	0.165	3.84	4.19
U	1.187 BSC		30.15 BSC	
V	0.131	0.188	3.33	4.77

### STYLE 1:

1. BASE
  2. EMITTER
- CASE: COLLECTOR

PowerBase is a trademark of Semiconductor Components Industries, LLC.

ON Semiconductor and  are registered trademarks of Semiconductor Components Industries, LLC (SCILLC). SCILLC reserves the right to make changes without further notice to any products herein. SCILLC makes no warranty, representation or guarantee regarding the suitability of its products for any particular purpose, nor does SCILLC assume any liability arising out of the application or use of any product or circuit, and specifically disclaims any and all liability, including without limitation special, consequential or incidental damages. "Typical" parameters which may be provided in SCILLC data sheets and/or specifications can and do vary in different applications and actual performance may vary over time. All operating parameters, including "Typicals" must be validated for each customer application by customer's technical experts. SCILLC does not convey any license under its patent rights nor the rights of others. SCILLC products are not designed, intended, or authorized for use as components in systems intended for surgical implant into the body, or other applications intended to support or sustain life, or for any other application in which the failure of the SCILLC product could create a situation where personal injury or death may occur. Should Buyer purchase or use SCILLC products for any such unintended or unauthorized application, Buyer shall indemnify and hold SCILLC and its officers, employees, subsidiaries, affiliates, and distributors harmless against all claims, costs, damages, and expenses, and reasonable attorney fees arising out of, directly or indirectly, any claim of personal injury or death associated with such unintended or unauthorized use, even if such claim alleges that SCILLC was negligent regarding the design or manufacture of the part. SCILLC is an Equal Opportunity/Affirmative Action Employer. This literature is subject to all applicable copyright laws and is not for resale in any manner.

### PUBLICATION ORDERING INFORMATION

#### LITERATURE FULFILLMENT:

Literature Distribution Center for ON Semiconductor  
P.O. Box 61312, Phoenix, Arizona 85082-1312 USA  
Phone: 480-829-7710 or 800-344-3860 Toll Free USA/Canada  
Fax: 480-829-7709 or 800-344-3867 Toll Free USA/Canada  
Email: orderlit@onsemi.com

N. American Technical Support: 800-282-9855 Toll Free  
USA/Canada

Japan: ON Semiconductor, Japan Customer Focus Center  
2-9-1 Kamimeguro, Meguro-ku, Tokyo, Japan 153-0051  
Phone: 81-3-5773-3850

ON Semiconductor Website: <http://onsemi.com>

Order Literature: <http://www.onsemi.com/litorder>

For additional information, please contact your local Sales Representative.