



2SA1020

PNP SILICON TRANSISTOR

SILICON PNP EPITAXIAL TRANSISTOR

DESCRIPTION

The UTC 2SA1020 is designed for power amplifier and power switching applications.

FEATURES

*Low collector saturation voltage:

$$V_{CE(SAT)} = -0.5V(\text{max.}) \quad (I_C = -1A)$$

*High speed switching time: $t_{STG} = 1.0\mu s(\text{Typ.})$

*Complement to UTC 2SC2655

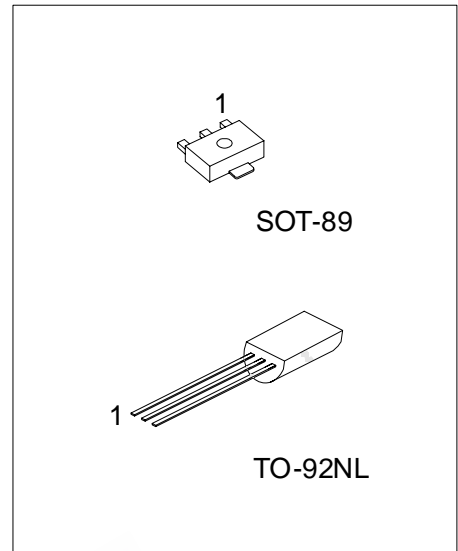

*Pb-free plating product number: 2SA1020L

ORDERING INFORMATION

Order Number		Package	Pin Assignment			Packing
Normal	Lead Free Plating		1	2	3	
2SA1020-x-AB3-R	2SA1020L-x-AB3-R	SOT-89	B	C	E	Tape Reel
2SA1020-x-T9N-B	2SA1020L-x-T9N-B	TO-92NL	E	C	B	Tape Box
2SA1020-x-T9N-K	2SA1020L-x-T9N-K	TO-92NL	E	C	B	Bulk

<p>2SA1020L-x-AB3-R</p> <p>(1) Packing Type (2) Package Type (3) Rank (4) Lead Plating</p>	<p>(1) B: Tape Box, K: Bulk, R: Tape Reel (2) AB3: SOT-89, T9N: TO-92NL (3) x: refer to Classification of h_{FE1} (4) L: Lead Free Plating Blank: Pb/Sn</p>
--	--

2SA1020

PNP SILICON TRANSISTOR

■ ABSOLUTE MAXIMUM RATINGS (Ta=25°C, unless otherwise specified)

PARAMETER		SYMBOL	RATINGS	UNIT
Collector-Base Voltage		V_{CBO}	-50	V
Collector-Emitter Voltage		V_{CEO}	-50	V
Emitter-Base Voltage		V_{EBO}	-5	V
Collector Current		I_C	-2	A
Collector Power Dissipation	TO-92NL	P_C	900	mW
	SOT-89		500	mW
Junction Temperature		T_J	150	°C
Storage Temperature		T_{STG}	-55 ~ +150	°C

Note Absolute maximum ratings are those values beyond which the device could be permanently damaged.

Absolute maximum ratings are stress ratings only and functional device operation is not implied.

■ ELECTRICAL CHARACTERISTICS (Ta=25°C, unless otherwise specified)

PARAMETER		SYMBOL	TEST CONDITIONS	MIN	TYP	MAX	UNIT
Collector to Emitter Breakdown Voltage		BV_{CEO}	$I_C = -10mA, I_B = 0$	-50			V
Collector Cut-off Current		I_{CBO}	$V_{CB} = -50V, I_E = 0$			-1.0	μA
Emitter Cut-off Current		I_{EBO}	$V_{EB} = -5V, I_C = 0$			-1.0	μA
DC Current Gain	h_{FE1}		$V_{CE} = -2V, I_C = -0.5A$	70		240	
	h_{FE2}		$V_{CE} = -2V, I_C = -1.5A$	40			
Collector to Emitter Saturation Voltage		$V_{CE(SAT)}$	$I_C = -1A, I_B = -0.05A$			-0.5	V
Base to Emitter Saturation Voltage		$V_{BE(SAT)}$	$I_C = -1A, I_B = -0.05A$			-1.2	V
Transition Frequency		f_T	$V_{CE} = -2V, I_C = -0.5A$		100		MHz
Collector Output Capacitance		C_{ob}	$V_{CB} = -10V, I_E = 0, f = 1MHz$		40		pF
Switching Time	Turn-on Time	t_{ON}			0.1		μs
	Storage Time	t_{STG}			1.0		μs
	Fall Time	t_F				0.1	

■ CLASSIFICATION OF h_{FE1}

RANK	O	Y
RANGE	70 - 140	120 - 240

TYPICAL CHARACTERISTICS

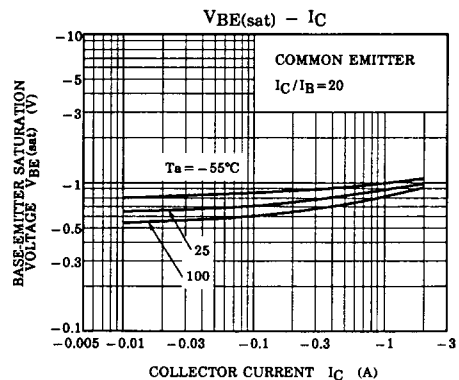
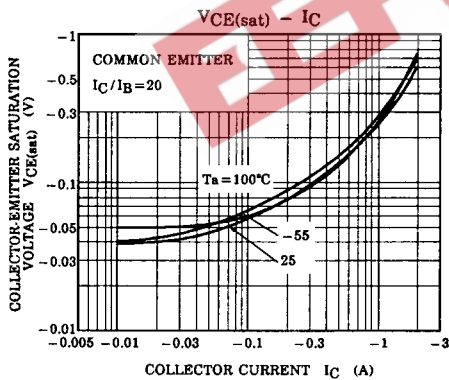
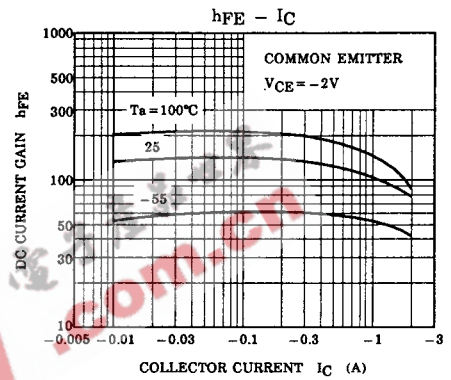
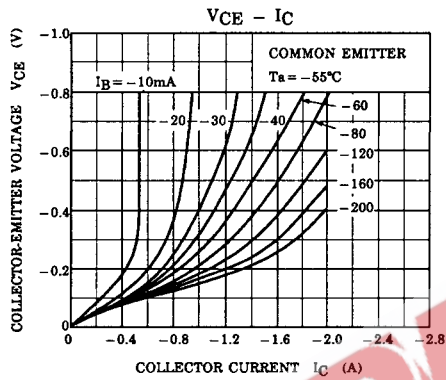
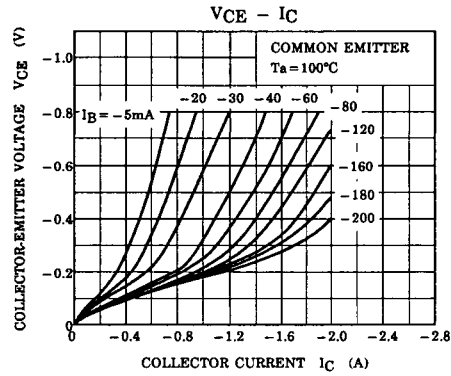
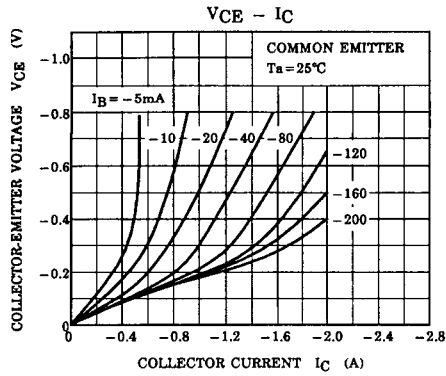

■ TYPICAL CHARACTERISTICS(Cont.)

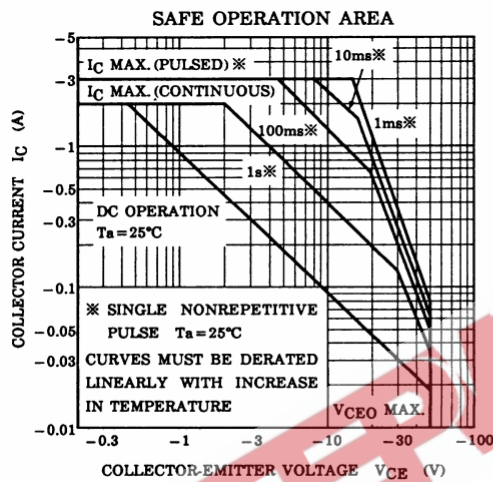
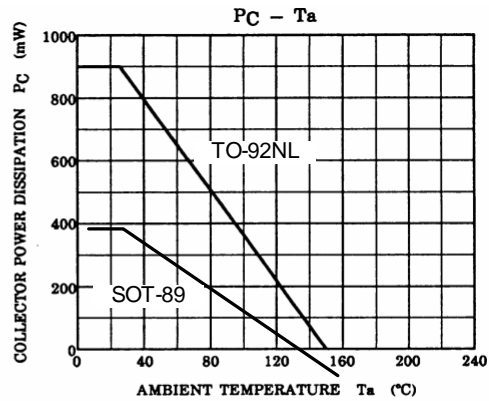
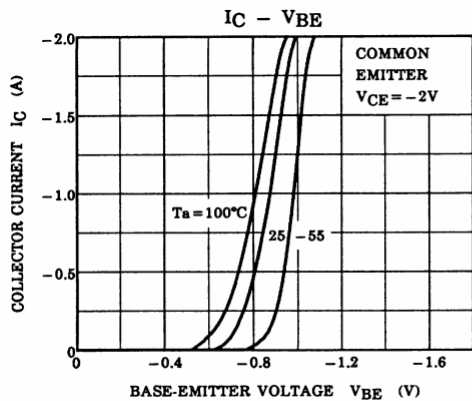

UTC assumes no responsibility for equipment failures that result from using products at values that exceed, even momentarily, rated values (such as maximum ratings, operating condition ranges, or other parameters) listed in products specifications of any and all UTC products described or contained herein. UTC products are not designed for use in life support appliances, devices or systems where malfunction of these products can be reasonably expected to result in personal injury. Reproduction in whole or in part is prohibited without the prior written consent of the copyright owner. The information presented in this document does not form part of any quotation or contract, is believed to be accurate and reliable and may be changed without notice.