

# 2SA1493

Silicon PNP Epitaxial Planar Transistor (Complement to type 2SC3857)

Application : Audio and General Purpose

**Absolute maximum ratings** (Ta=25°C)

Symbol	2SA1493	Unit
V <sub>CB0</sub>	-200	V
V <sub>CE0</sub>	-200	V
V <sub>EB0</sub>	-6	V
I <sub>c</sub>	-15	A
I <sub>B</sub>	-5	A
P <sub>c</sub>	150(T <sub>C</sub> =25°C)	W
T <sub>j</sub>	150	°C
T <sub>stg</sub>	-55 to +150	°C

**Electrical Characteristics** (Ta=25°C)

Symbol	Conditions	2SA1493	Unit
I <sub>CB0</sub>	V <sub>CB</sub> =-200V	-100max	μA
I <sub>EB0</sub>	V <sub>EB</sub> =-6V	-100max	μA
V(BR)CEO	I <sub>c</sub> =-50mA	-200min	V
h <sub>FE</sub>	V <sub>CE</sub> =-4V, I <sub>c</sub> =-5A	50min*	
V <sub>CE(sat)</sub>	I <sub>c</sub> =-10A, I <sub>B</sub> =-1A	-3.0max	V
f <sub>r</sub>	V <sub>CE</sub> =-12V, I <sub>E</sub> =0.5A	20typ	MHz
COB	V <sub>CB</sub> =-10V, f=1MHz	400typ	pF

\*h<sub>FE</sub> Rank  $\bar{O}$ (50to100), P(70to140), Y(90to180)

**External Dimensions MT-200**

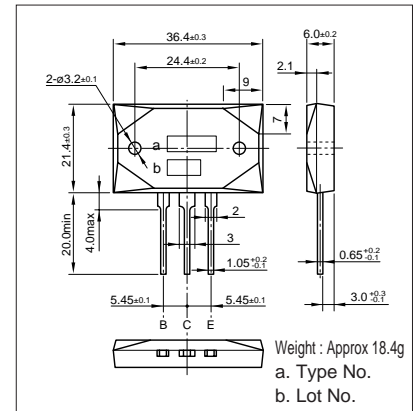

**Typical Switching Characteristics (Common Emitter)**

V <sub>CC</sub> (V)	R <sub>L</sub> (Ω)	I <sub>c</sub> (A)	V <sub>BB1</sub> (V)	V <sub>BB2</sub> (V)	I <sub>B1</sub> (mA)	I <sub>B2</sub> (mA)	t <sub>on</sub> (μs)	t <sub>stg</sub> (μs)	t <sub>f</sub> (μs)
-60	12	-5	-10	5	-500	500	0.3typ	0.9typ	0.2typ

**I<sub>c</sub>-V<sub>CE</sub> Characteristics (Typical)**

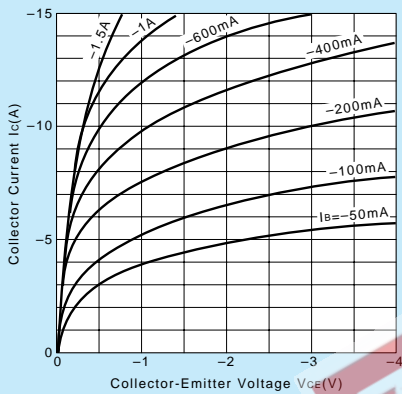

**V<sub>CE(sat)</sub>-I<sub>B</sub> Characteristics (Typical)**

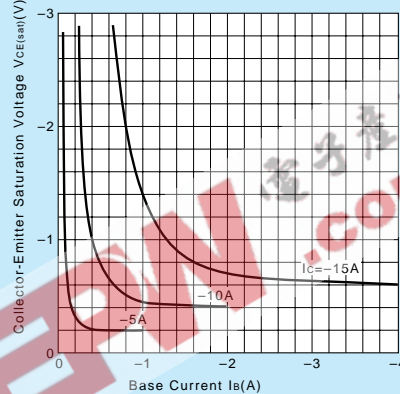

**I<sub>c</sub>-V<sub>BE</sub> Temperature Characteristics (Typical)**

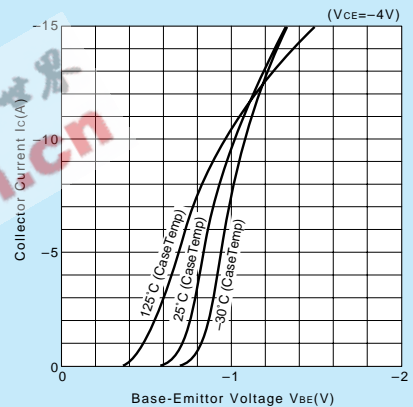

**h<sub>FE</sub>-I<sub>c</sub> Characteristics (Typical)**

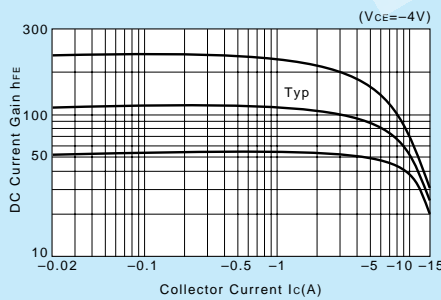

**h<sub>FE</sub>-I<sub>c</sub> Temperature Characteristics (Typical)**

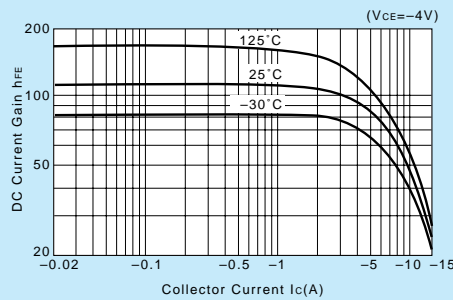

**θ<sub>j-a</sub>-t Characteristics**

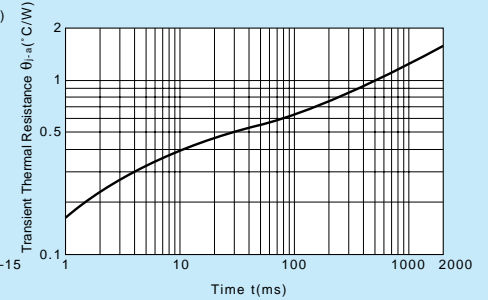

**f<sub>t</sub>-I<sub>E</sub> Characteristics (Typical)**

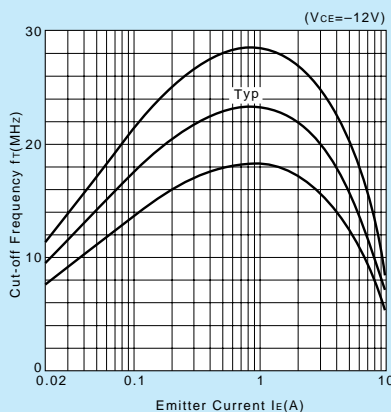

**Safe Operating Area (Single Pulse)**

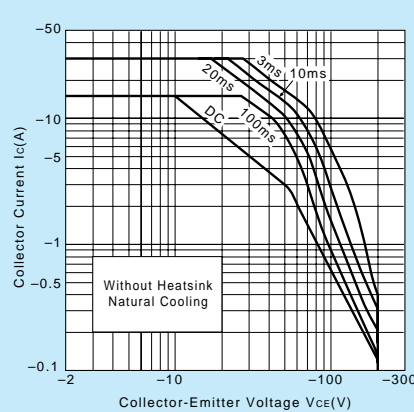

**P<sub>c</sub>-T<sub>a</sub> Derating**

