

2SA1796 (TE7T4)

-7A PNP

OUTLINE DIMENSIONS

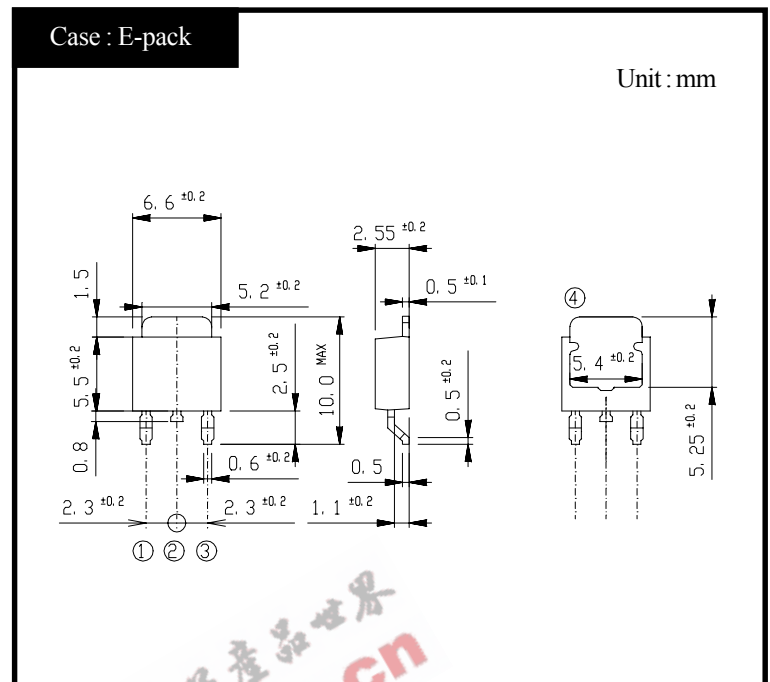

RATINGS

● Absolute Maximum Ratings

Item	Symbol	Conditions	Ratings	Unit
Storage Temperature	T_{stg}		-55~150	°C
Junction Temperature	T_j		150	°C
Collector to Base Voltage	V_{CBO}		-60	V
Collector to Emitter Voltage	V_{CEO}		-40	V
Emitter to Base Voltage	V_{EBO}		-7	V
Collector Current DC	I_C		-7	A
Collector Current Peak	I_{CP}		-14	A
Base Current DC	I_B		-1.5	A
Base Current Peak	I_{BP}		-2	A
Total Transistor Dissipation	P_T	$T_c = 25^\circ\text{C}$	10	W

● Electrical Characteristics ($T_c=25^\circ\text{C}$)

Item	Symbol	Conditions	Ratings	Unit
Collector to Emitter Sustaining Voltage	$V_{CEO(sus)}$	$I_C = -0.1\text{A}$	Min -40	V
Collector Cutoff Current	I_{CBO}	At rated Voltage	Max -0.1	mA
	I_{CEO}		Max -0.1	
Emitter Cutoff Current	I_{EBO}	At rated Voltage	Max -0.1	mA
DC Current Gain	h_{FE}	$V_{CE} = -2\text{V}, I_C = -3.5\text{A}$	Min 70	
Collector to Emitter Saturation Voltage	$V_{CE(sat)}$	$I_C = -3.5\text{A}$	Max -0.3	V
Base to Emitter Saturation Voltage	$V_{BE(sat)}$	$I_B = -0.2\text{A}$	Max -1.2	V
Thermal Resistance	θ_{jc}	Junction to case	Max 12.5	°C/W
Transition Frequency	f_T	$V_{CE} = -10\text{V}, I_C = -0.7\text{A}$	TYP 50	MHz
Turn on Time	t_{on}	$I_C = -3.5\text{A}$ $I_{B1} = -0.35\text{A}, I_{B2} = -0.35\text{A}$ $R_L = 8\Omega, V_{BB2} = -4\text{V}$	Max 0.3	μs
Storage Time	t_s		Max 1.5	
Fall Time	t_f		Max 0.5	

2SA1796

$h_{FE} - I_c$

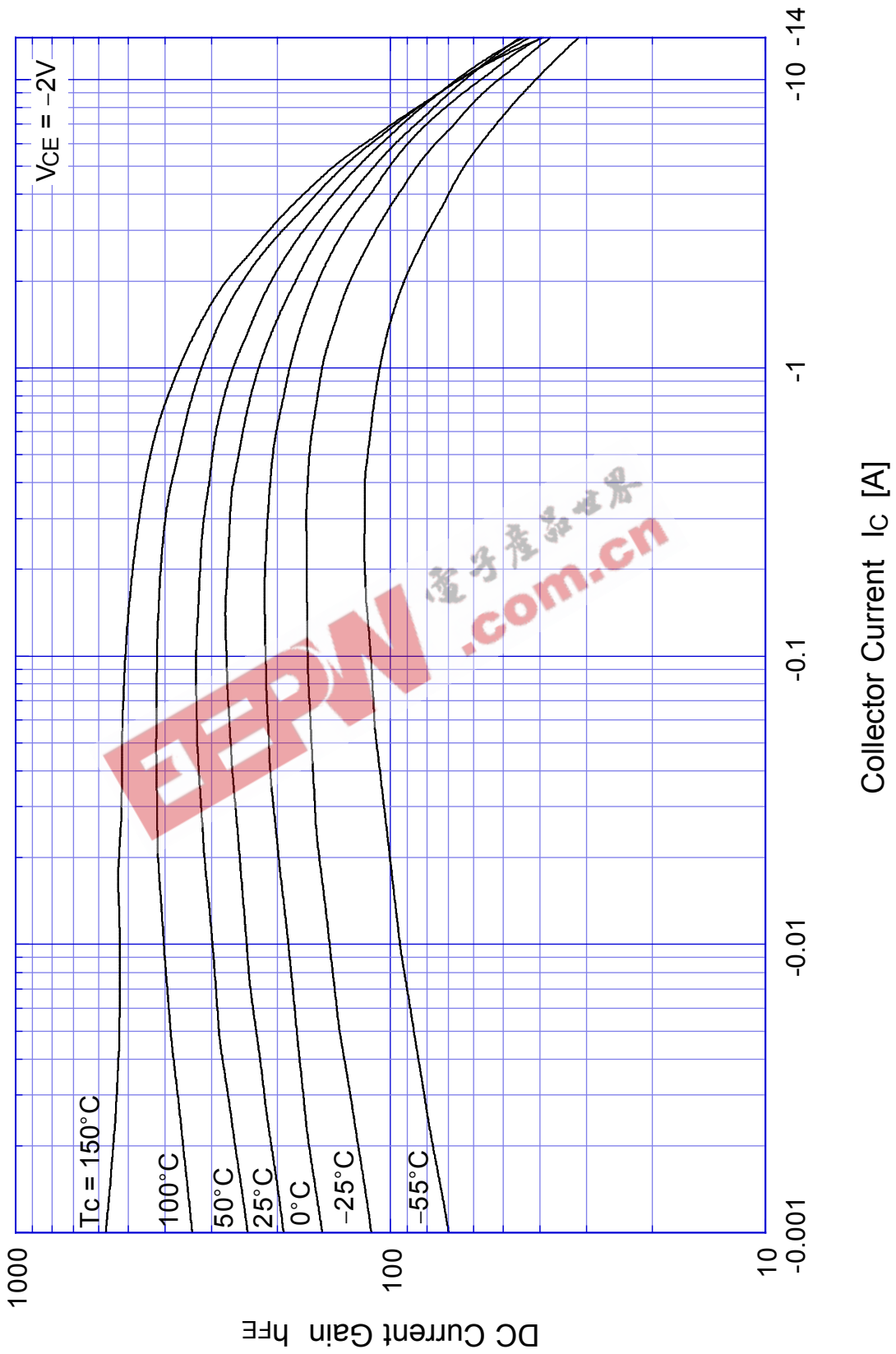

2SA1796 Saturation Voltage

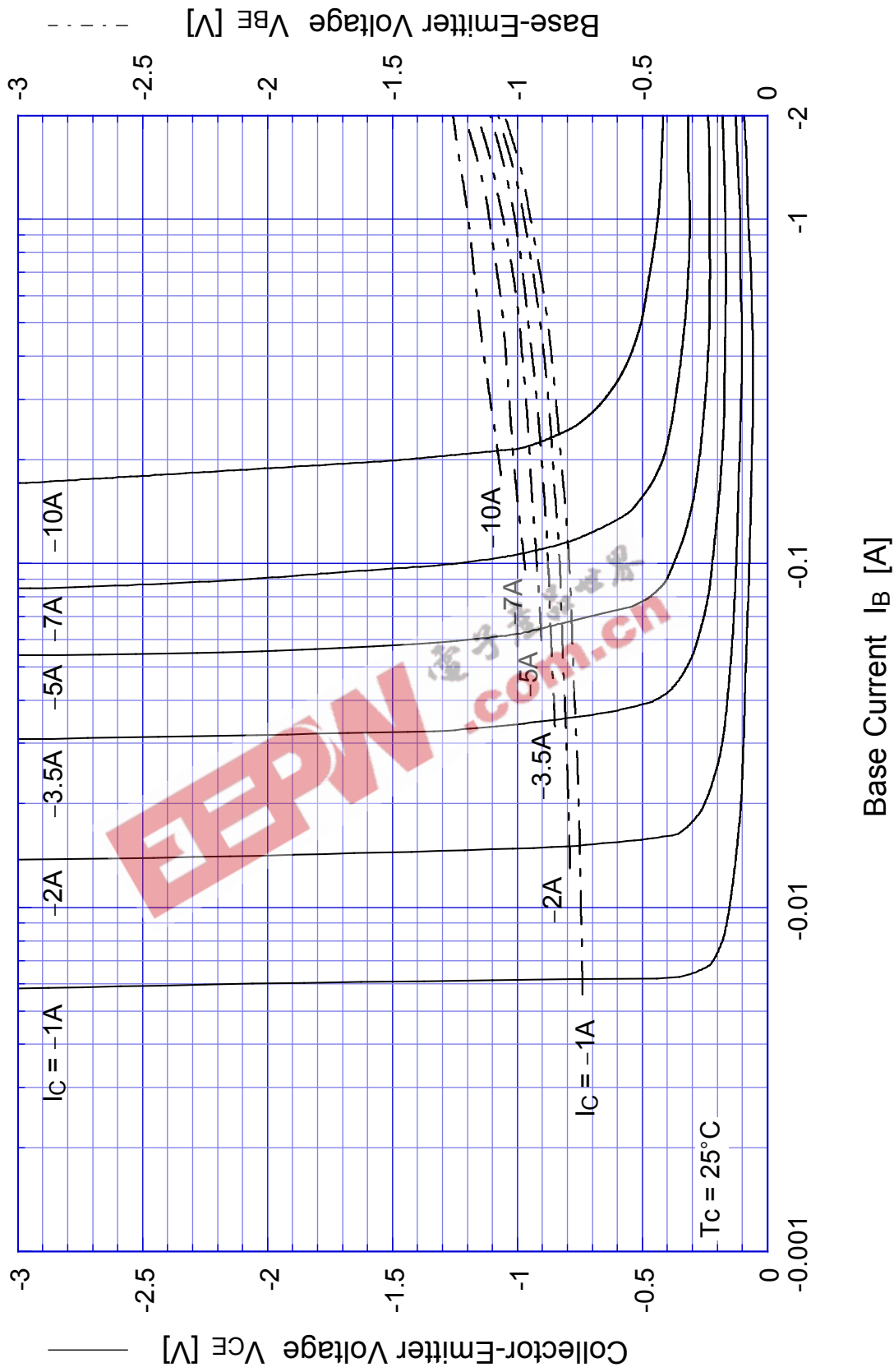

2SA1796

Switching Time - I_C

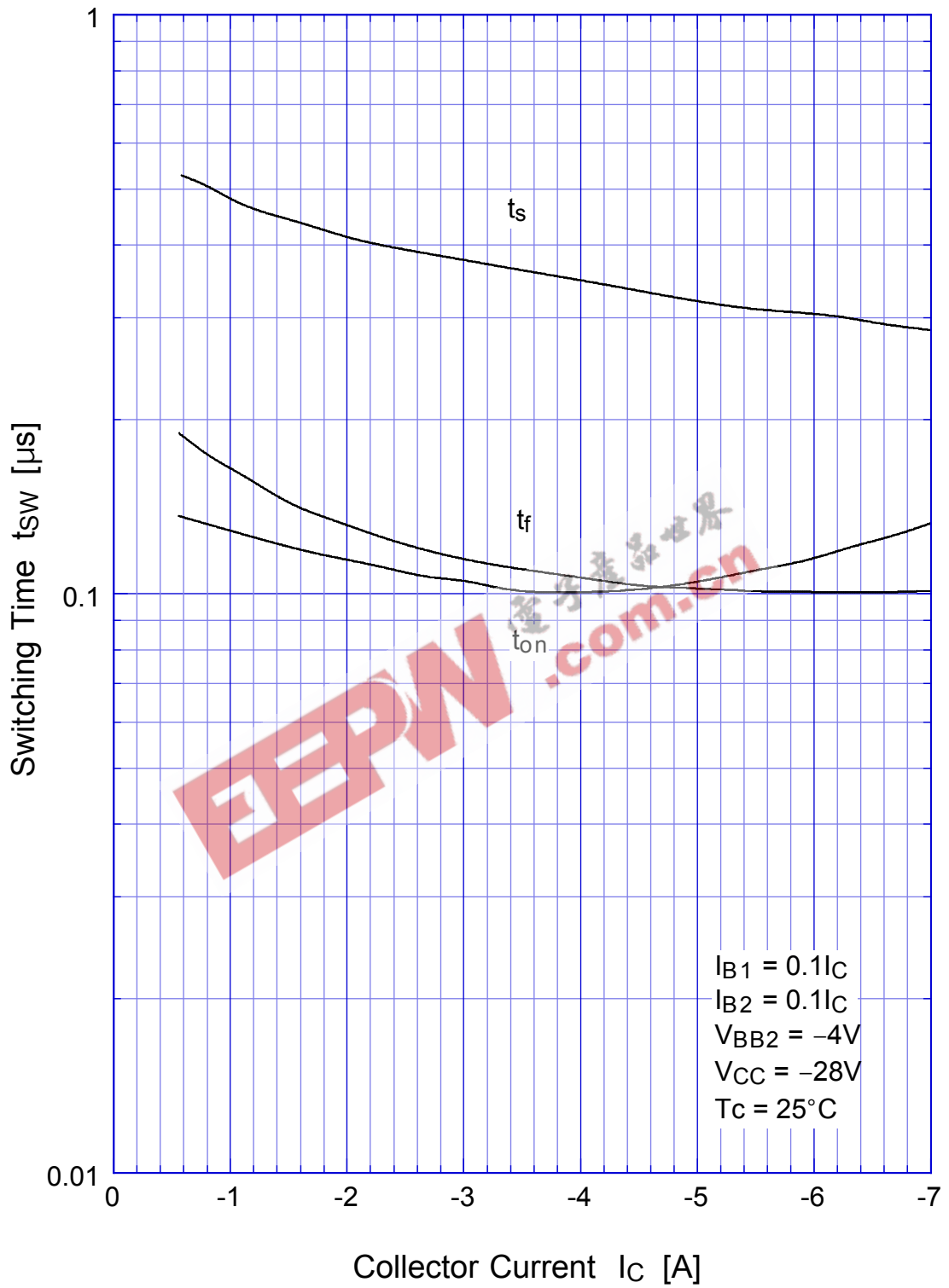

2SA1796

Switching Time - Tc

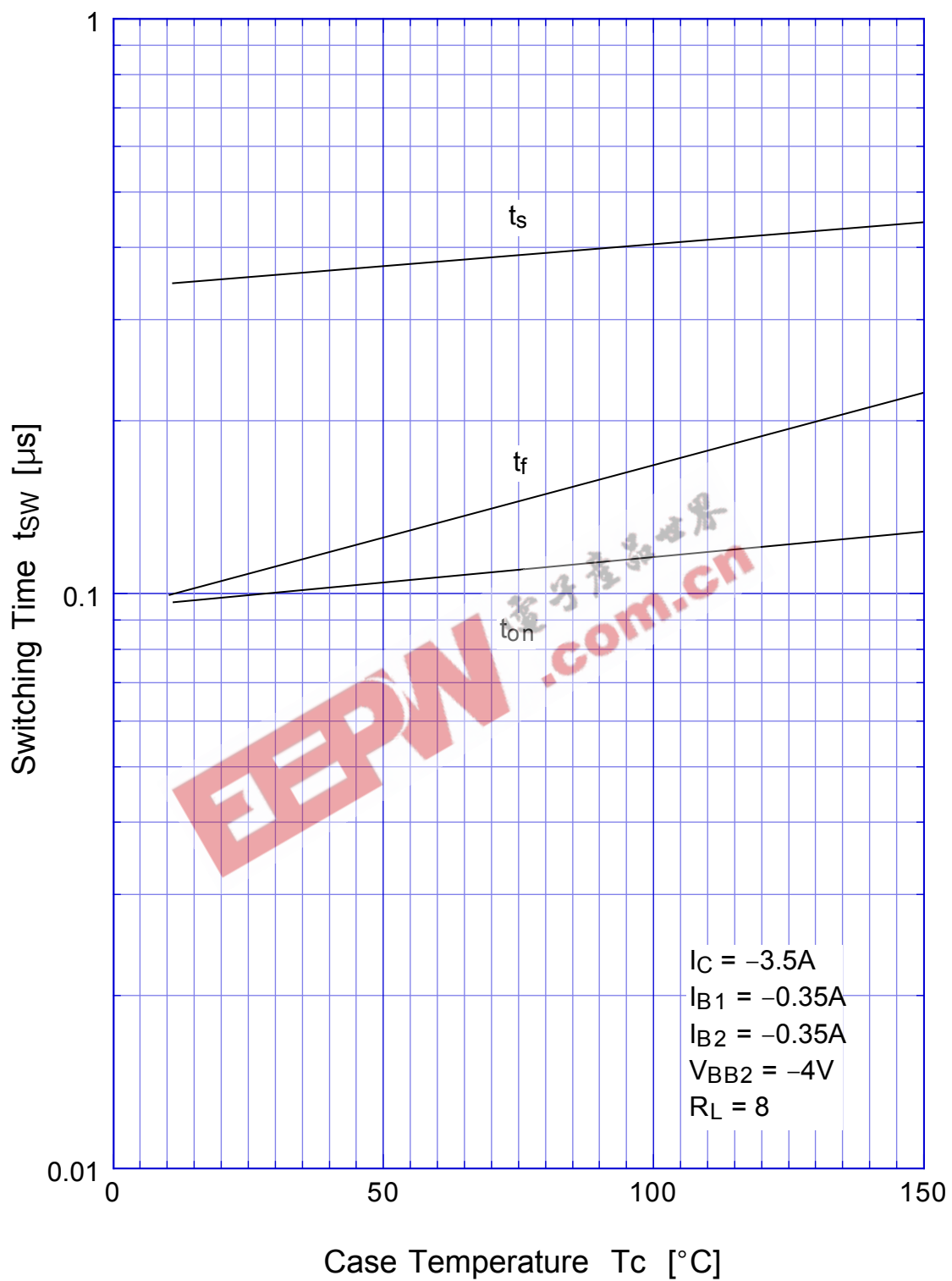

2SA1796 Transient Thermal Impedance

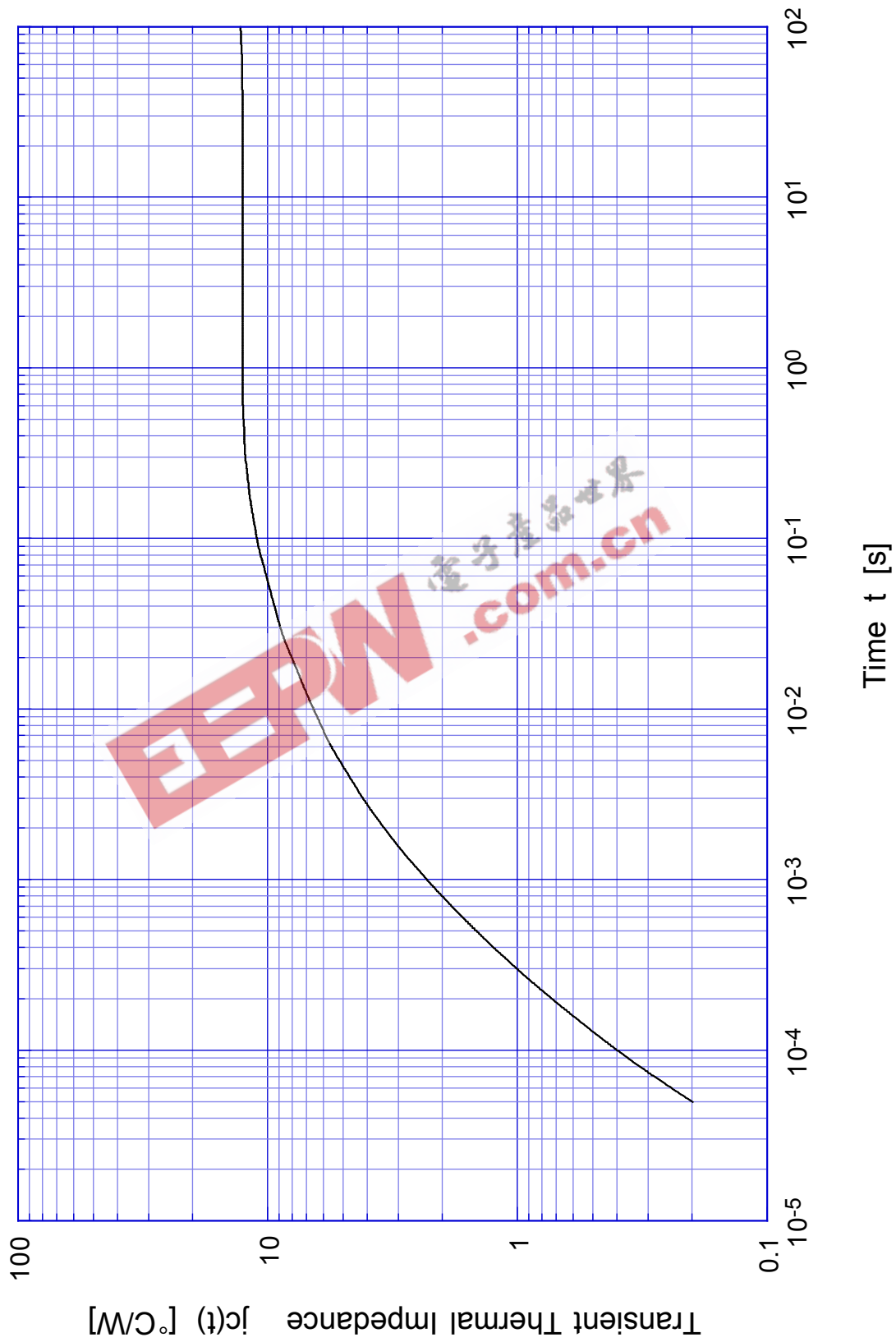

2SA1796

Forward Bias SOA

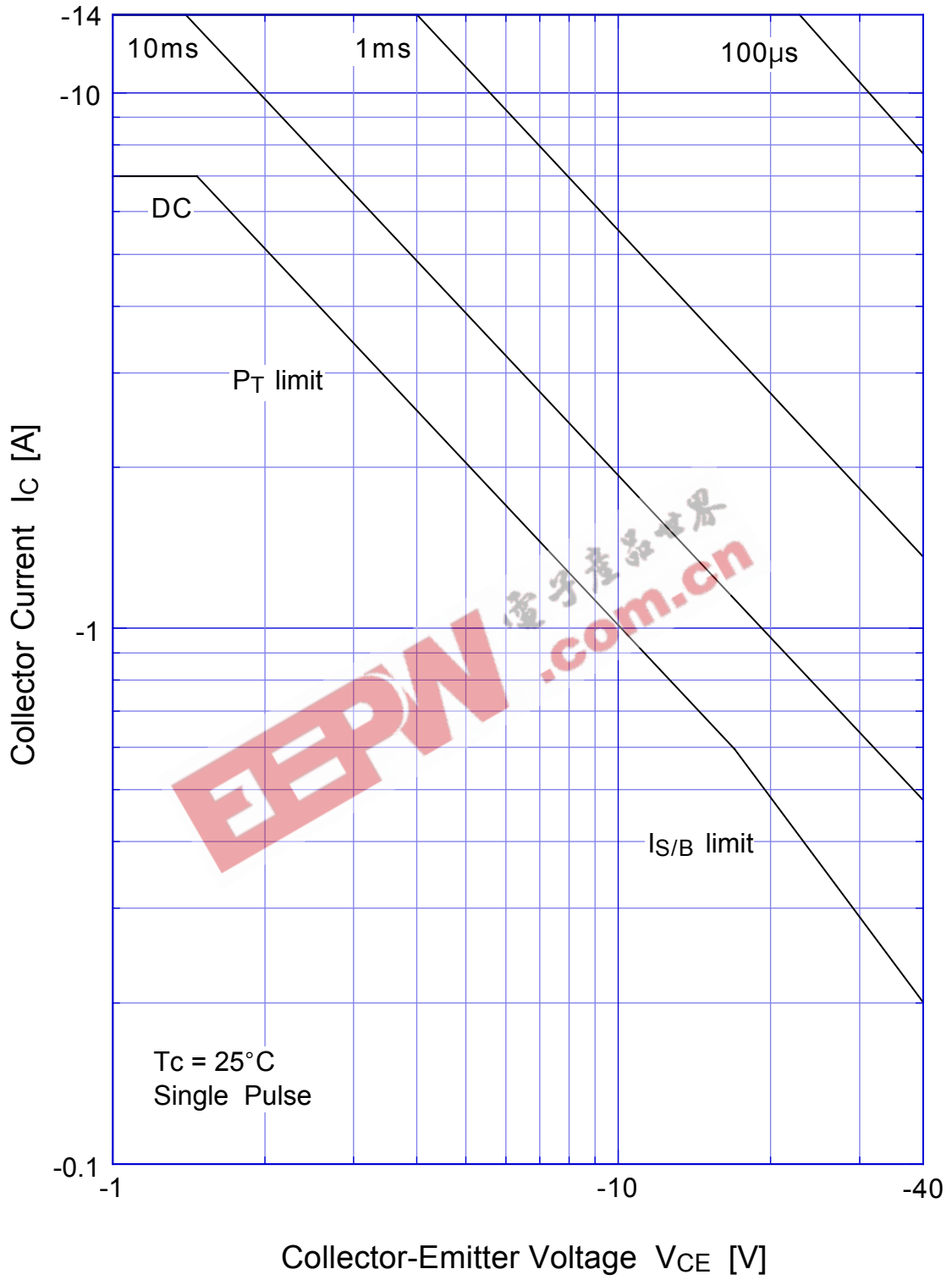

2SA1796 Collector Current Derating

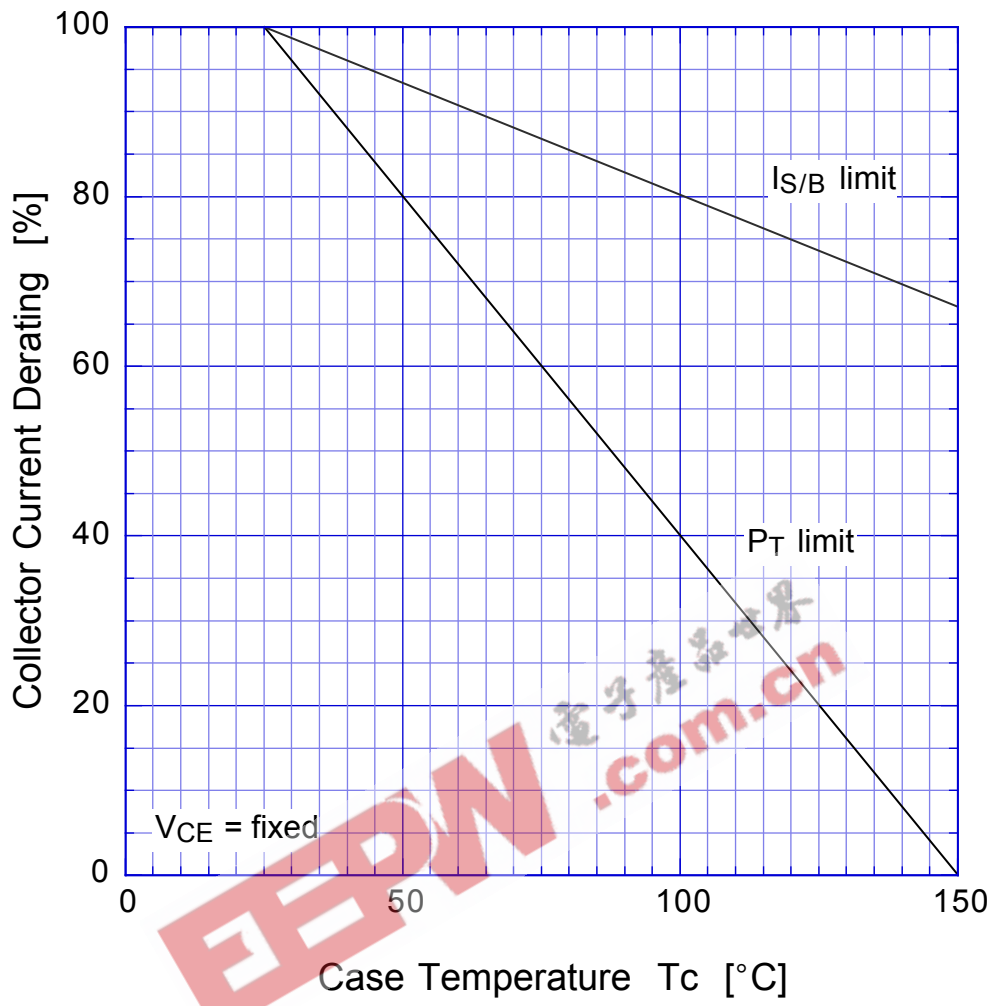

2SA1796

Reverse Bias SOA

