



2SA733

PNP SILICON TRANSISTOR

LOW FREQUENCY AMPLIFIER PNP EPITAXIAL SILICON TRANSISTOR

DESCRIPTION

The UTC **2SA733** is a low frequency amplifier.

FEATURES

- * Collector-Emitter voltage:
BV_{CBO}=-50V
- * Collector current up to -150mA
- * High h_{FE} linearity
- * Complimentary to 2SC945

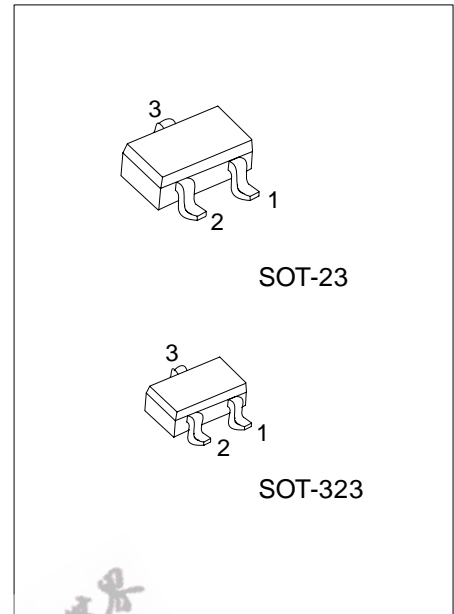

*Pb-free plating product number:2SA733L

ORDERING INFORMATION

Order Number		Package	Pin Assignment			Packing
Normal	Lead Free Plating		1	2	3	
2SA733-x-AE3-R	2SA733L-x-AE3-R	SOT-23	E	C	B	Tape Reel
2SA733-x-AL3-R	2SA733L-x-AL3-R	SOT-323	E	C	B	Tape Reel

<p>2SA733L-x-AE3-R</p>	<p>(1) R: Tape Reel (2) AE3: SOT-23, AL3: SOT-323 (3) x: refer to Classification of h_{FE} (4) L: Lead Free Plating, Blank: Pb/Sn</p>
------------------------	---

MARKING

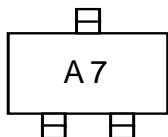

■ ABSOLUTE MAXIMUM RATING (Ta=25 , unless otherwise specified)

PARAMETER	SYMBOL	RATINGS	UNIT
Collector-Base Voltage	V _{CBO}	-60	V
Collector-Emitter Voltage	V _{CEO}	-50	V
Emitter-Base Voltage	V _{EBO}	-5	V
Collector Dissipation(Ta=25)	P _C	250	mW
Collector Current	I _C	-150	mA
Junction Temperature	T _J	125	
Storage Temperature	T _{STG}	-55 ~ +150	

Note Absolute maximum ratings are those values beyond which the device could be permanently damaged.

Absolute maximum ratings are stress ratings only and functional device operation is not implied.

■ ELECTRICAL CHARACTERISTICS (Ta=25 , unless otherwise specified)

PARAMETER	SYMBOL	TEST CONDITIONS	MIN	TYP	MAX	UNIT
Collector-Base Breakdown Voltage	BV _{CBO}	I _C =-100μA, I _E =0	-60			V
Collector-Emitter Breakdown Voltage	BV _{CEO}	I _C =-10mA, I _B =0	-50			V
Collector-Emitter Saturation Voltage	V _{CE(SAT)}	I _C =-100mA, I _B =-10mA		-0.1	-0.3	V
Collector Cut-Off Current	I _{CBO}	V _{CB} =-40V, I _E =0			-100	nA
Emitter Cut-Off Current	I _{EBO}	V _{EB} =-3V, I _C =0			-100	nA
DC Current Gain(note)	h _{FE}	V _{CE} =-6V, I _C =-1mA	90		600	
Current Gain Bandwidth Product	f _T	V _{CE} =-10V, I _C =-50mA	100	190		MHz
Output Capacitance	C _{ob}	V _{CB} =-10V, I _E =0, f=1MHz		2.0	3.0	pF
Noise Figure	NF	I _C =-0.1mA, V _{CE} =-6V R _G =10kΩ, f=100Hz		4.0	6.0	dB

■ CLASSIFICATION OF h_{FE}

RANK	R	Q	P	K
RANGE	90-180	135-270	200-400	300-600

TYPICAL CHARACTERISTICS

Fig.1 Static Characteristics

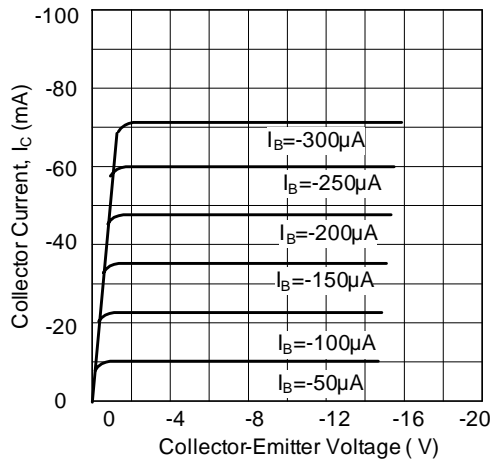

Fig.2 DC Current Gain

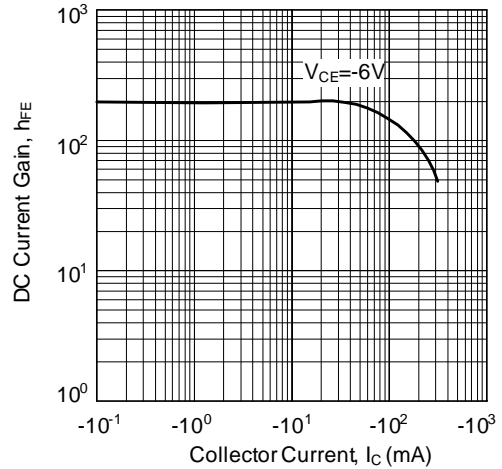

Fig.3 Base-Emitter on Voltage

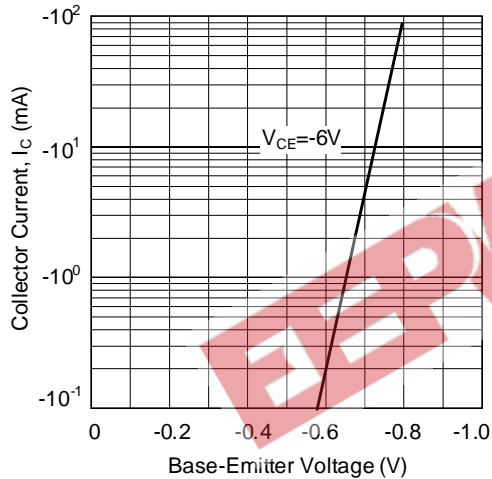

Fig.4 Saturation Voltage

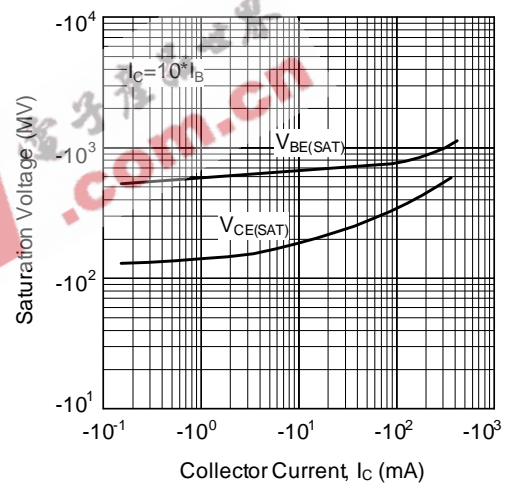

Fig.5 Current Gain-Bandwidth Product

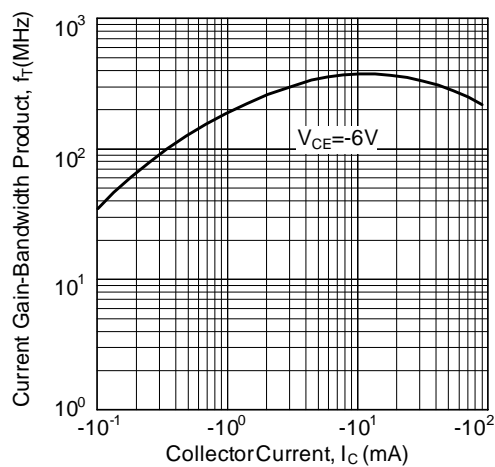
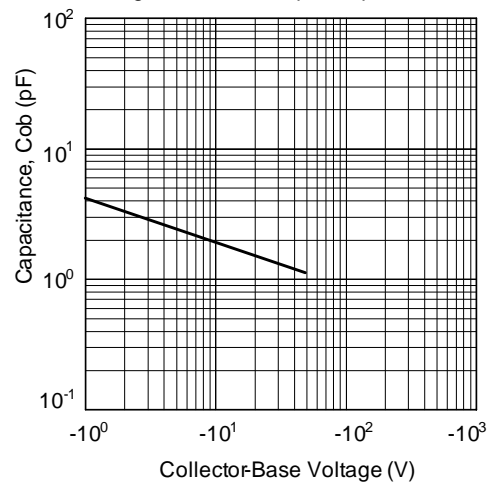

Fig.6 Collector Output Capacitance



EEPW 电子產品世界
.com.cn

UTC assumes no responsibility for equipment failures that result from using products at values that exceed, even momentarily, rated values (such as maximum ratings, operating condition ranges, or other parameters) listed in products specifications of any and all UTC products described or contained herein. UTC products are not designed for use in life support appliances, devices or systems where malfunction of these products can be reasonably expected to result in personal injury. Reproduction in whole or in part is prohibited without the prior written consent of the copyright owner. The information presented in this document does not form part of any quotation or contract, is believed to be accurate and reliable and may be changed without notice.