

# 2SA1598

(TP7T4)

## -7A PNP

### OUTLINE DIMENSIONS

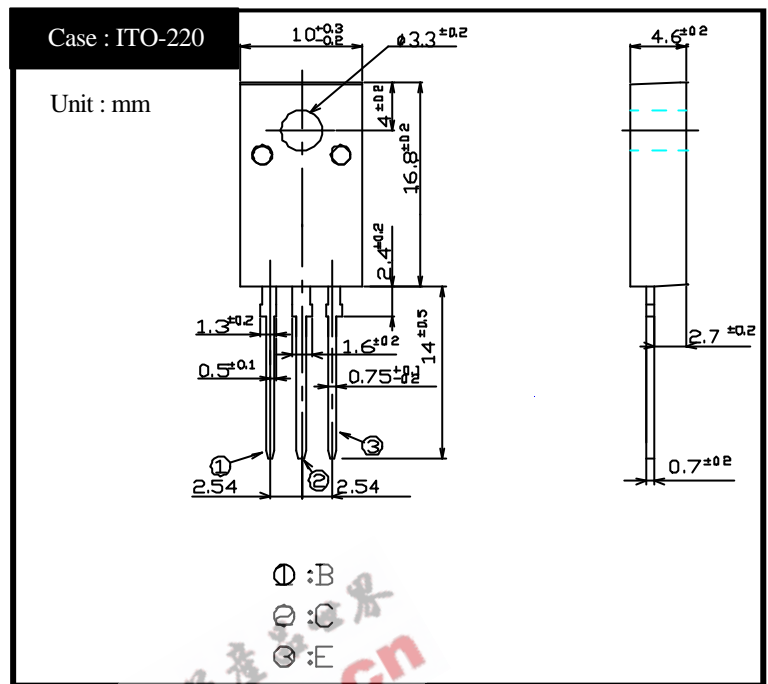

### RATINGS

#### Absolute Maximum Ratings

Item	Symbol	Conditions	Ratings	Unit
Storage Temperature	T <sub>stg</sub>		-55 ~ 150	
Junction Temperature	T <sub>j</sub>		150	
Collector to Base Voltage	V <sub>CBO</sub>		-60	V
Collector to Emitter Voltage	V <sub>CEO</sub>		-40	V
Emitter to Base Voltage	V <sub>EBO</sub>		-7	V
Collector Current DC	I <sub>C</sub>		-7	A
Collector Current Peak	I <sub>CP</sub>		-14	A
Base Current DC	I <sub>B</sub>		-1.5	A
Base Current Peak	I <sub>BP</sub>		-2	A
Total Transistor Dissipation	P <sub>T</sub>	T <sub>C</sub> = 25	25	W
Dielectric Strength	V <sub>dis</sub>	Terminal to case, AC 1 minute	2	kV
Mounting Torque	TOR	(Recommended torque : 0.3N·m)	0.5	N·m

#### Electrical Characteristics (T<sub>c</sub>=25 )

Item	Symbol	Conditions	Ratings	Unit
Collector to Emitter Sustaining Voltage	V <sub>CEO(sus)</sub>	I <sub>C</sub> = -0.1A	Min -40	V
Collector Cutoff Current	I <sub>CBO</sub>	At rated Voltage	Max -0.1	mA
			Max -0.1	
Emitter Cutoff Current	I <sub>EBO</sub>	At rated Voltage	Max -0.1	mA
DC Current Gain	h <sub>FE</sub>	V <sub>CE</sub> = -2V, I <sub>C</sub> = -3.5A	Min 70	
Collector to Emitter Saturation Voltage	V <sub>CE(sat)</sub>	I <sub>C</sub> = -3.5A	Max -0.3	V
Base to Emitter Saturation Voltage	V <sub>BE(sat)</sub>	I <sub>B</sub> = -0.2A	Max -1.2	V
Thermal Resistance	θ <sub>JC</sub>	Junction to case	Max 5	/W
Transition Frequency	f <sub>T</sub>	V <sub>CE</sub> = -10V, I <sub>C</sub> = -0.7A	TYP 50	MHz
Turn on Time	t <sub>on</sub>	I <sub>C</sub> = -3.5A I <sub>B1</sub> = -0.35A, I <sub>B2</sub> = -0.35A R <sub>L</sub> = 8 Ω, V <sub>BB2</sub> = -4V	Max 0.3	μs
Storage Time	t <sub>s</sub>		Max 1.5	
Fall Time	t <sub>f</sub>		Max 0.5	

# 2SA1598

## $h_{FE} - I_C$

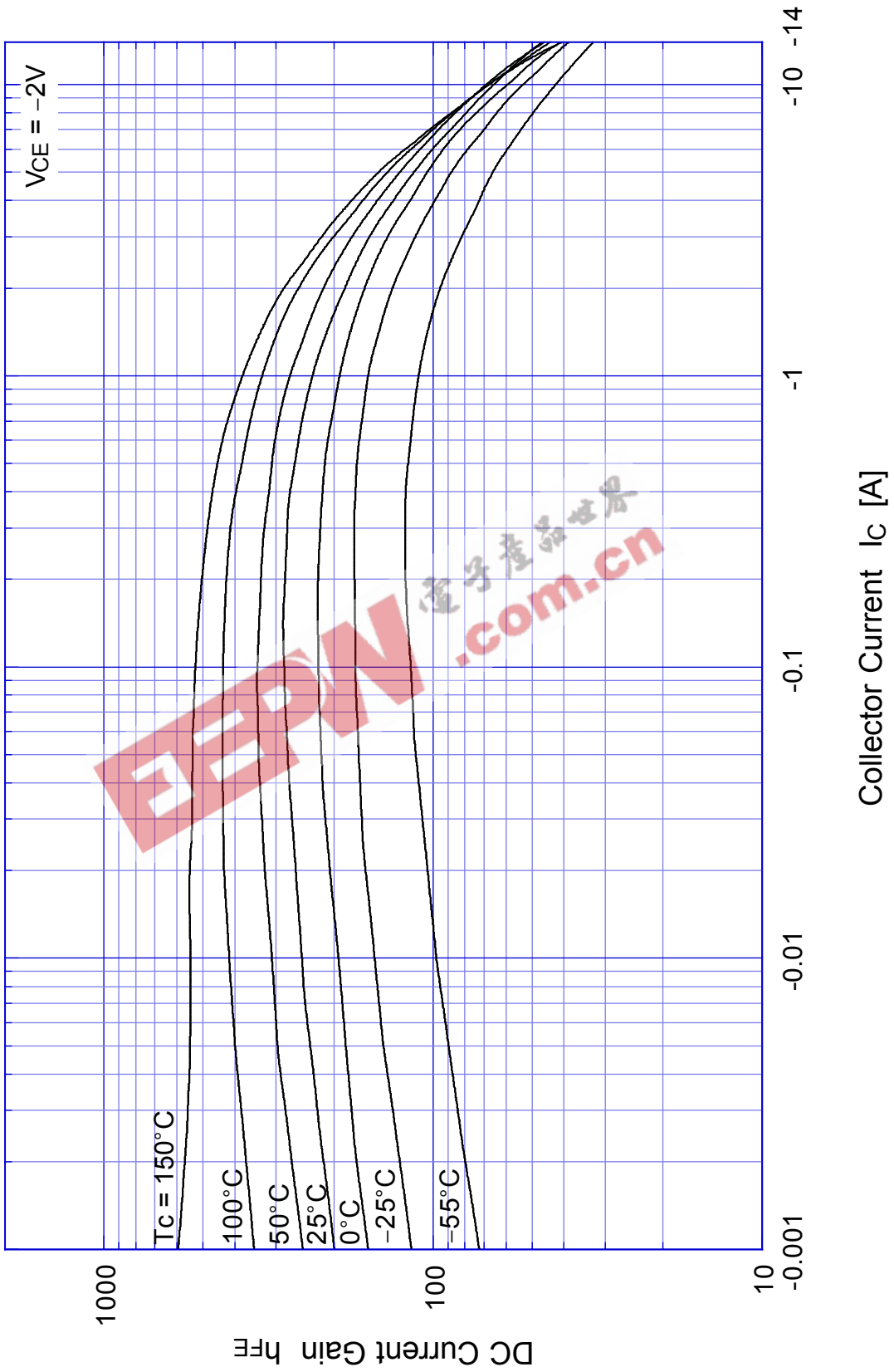

# 2SA1598 Saturation Voltage

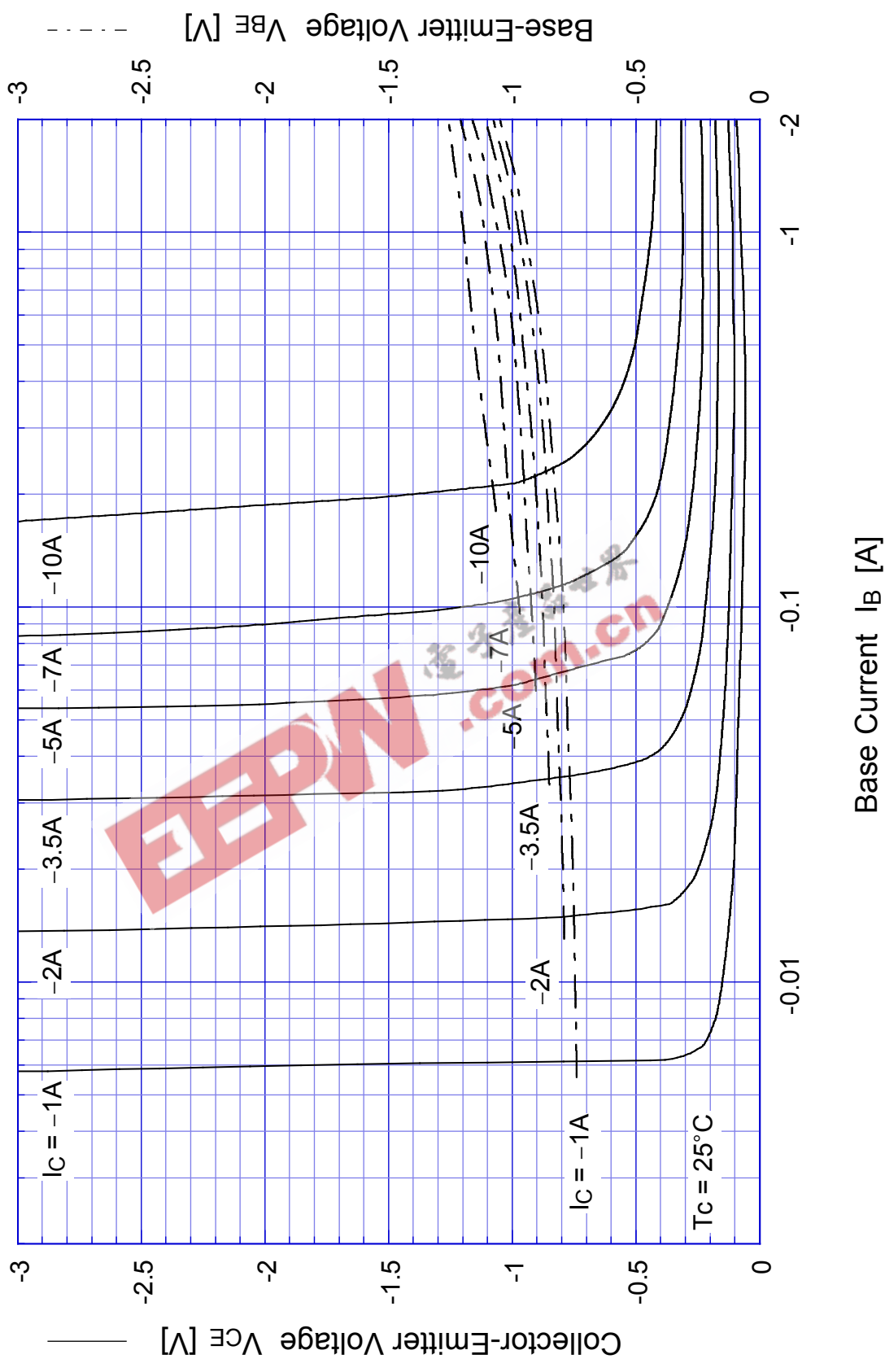

# 2SA1598

## Switching Time - $I_C$

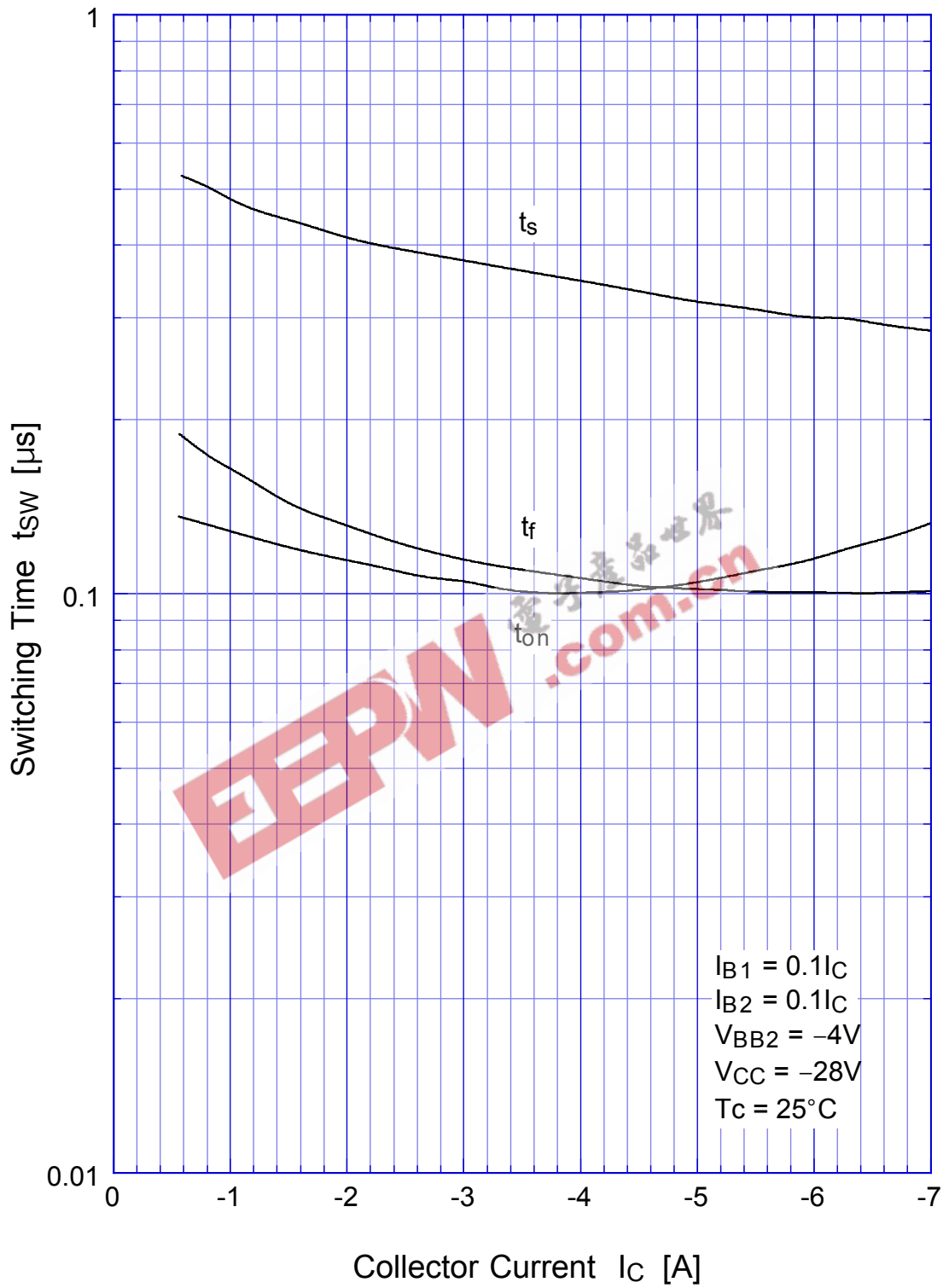

# 2SA1598

# Switching Time - Tc

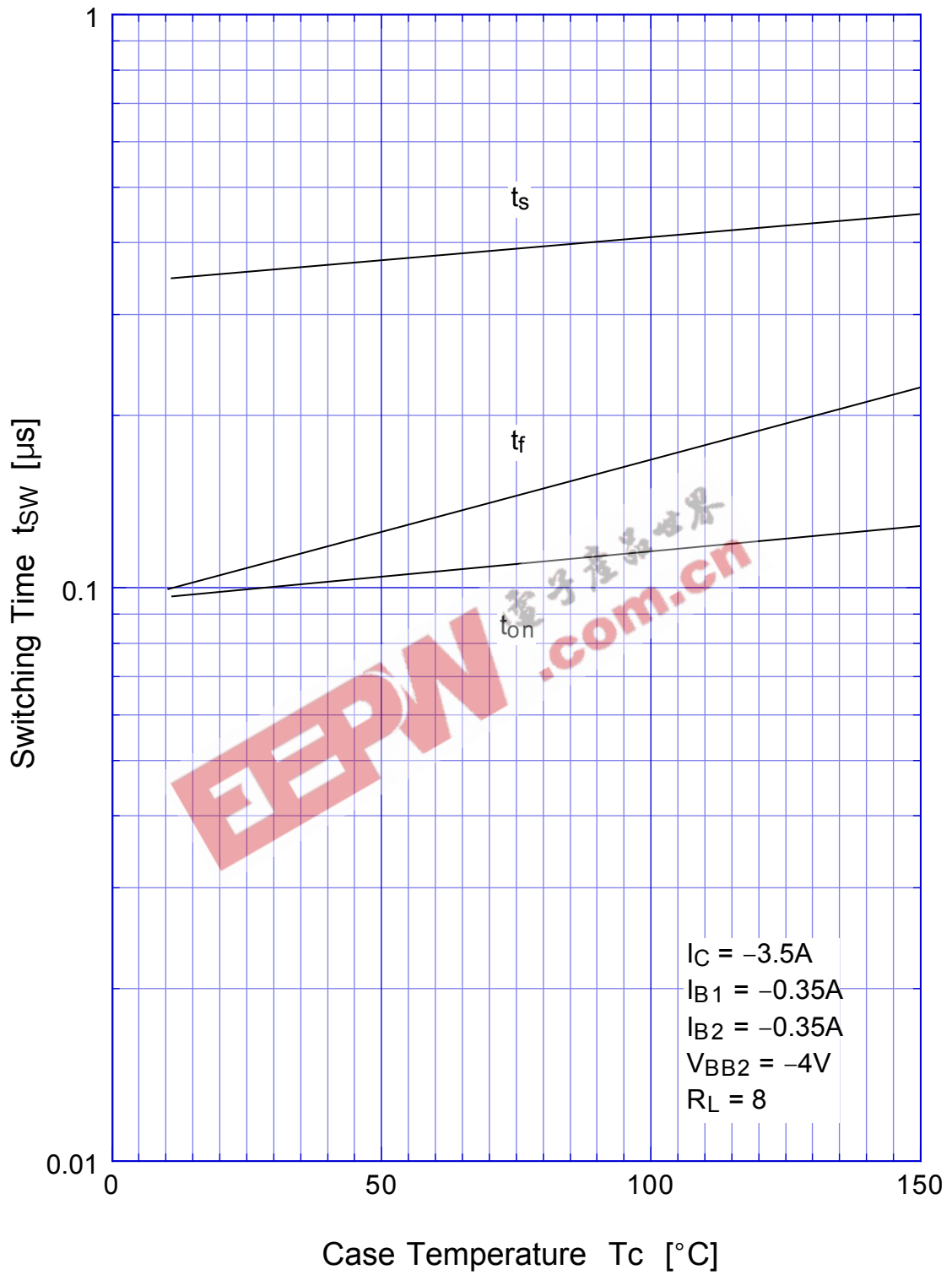

# 2SA1598 Transient Thermal Impedance

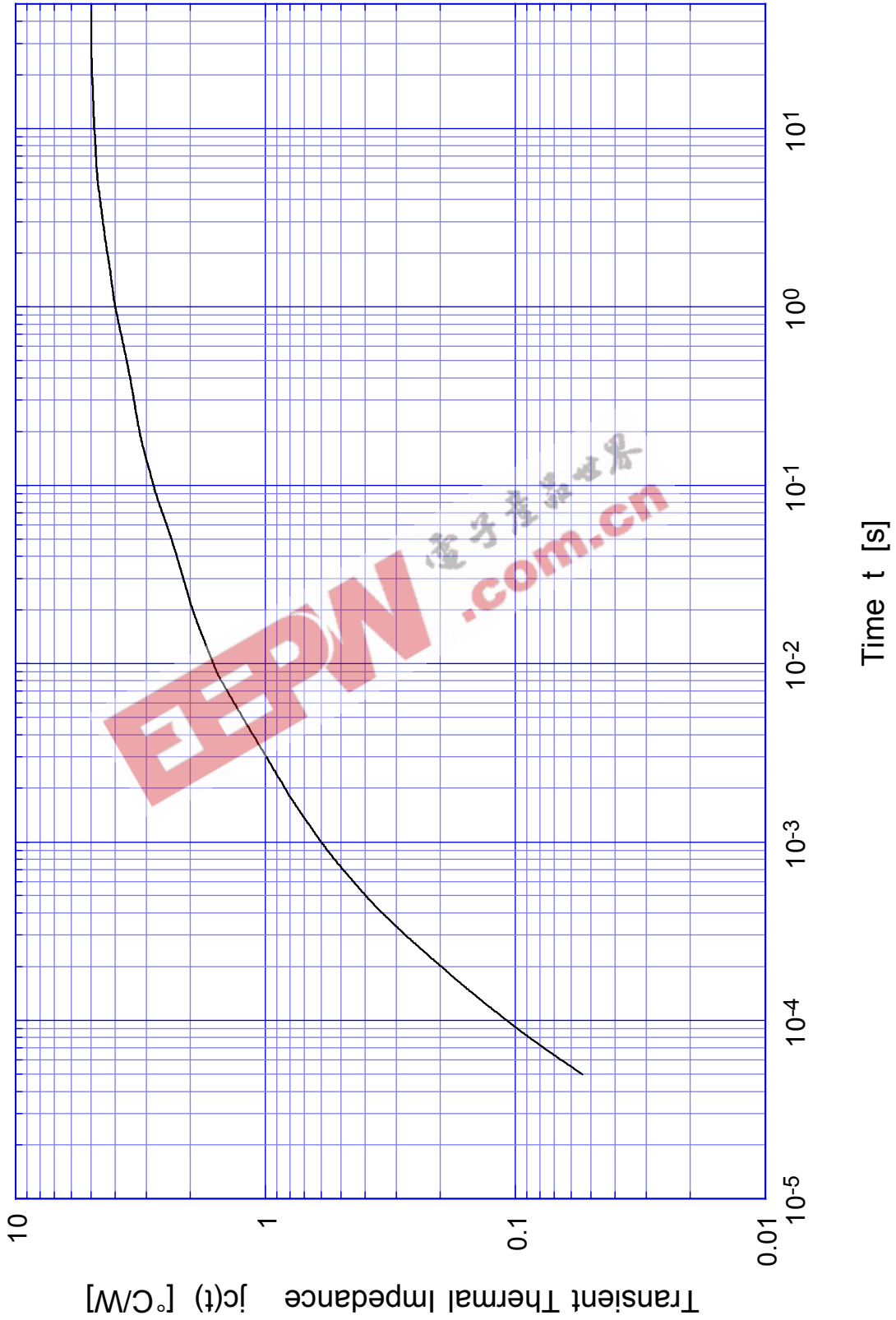

# 2SA1598

# Forward Bias SOA

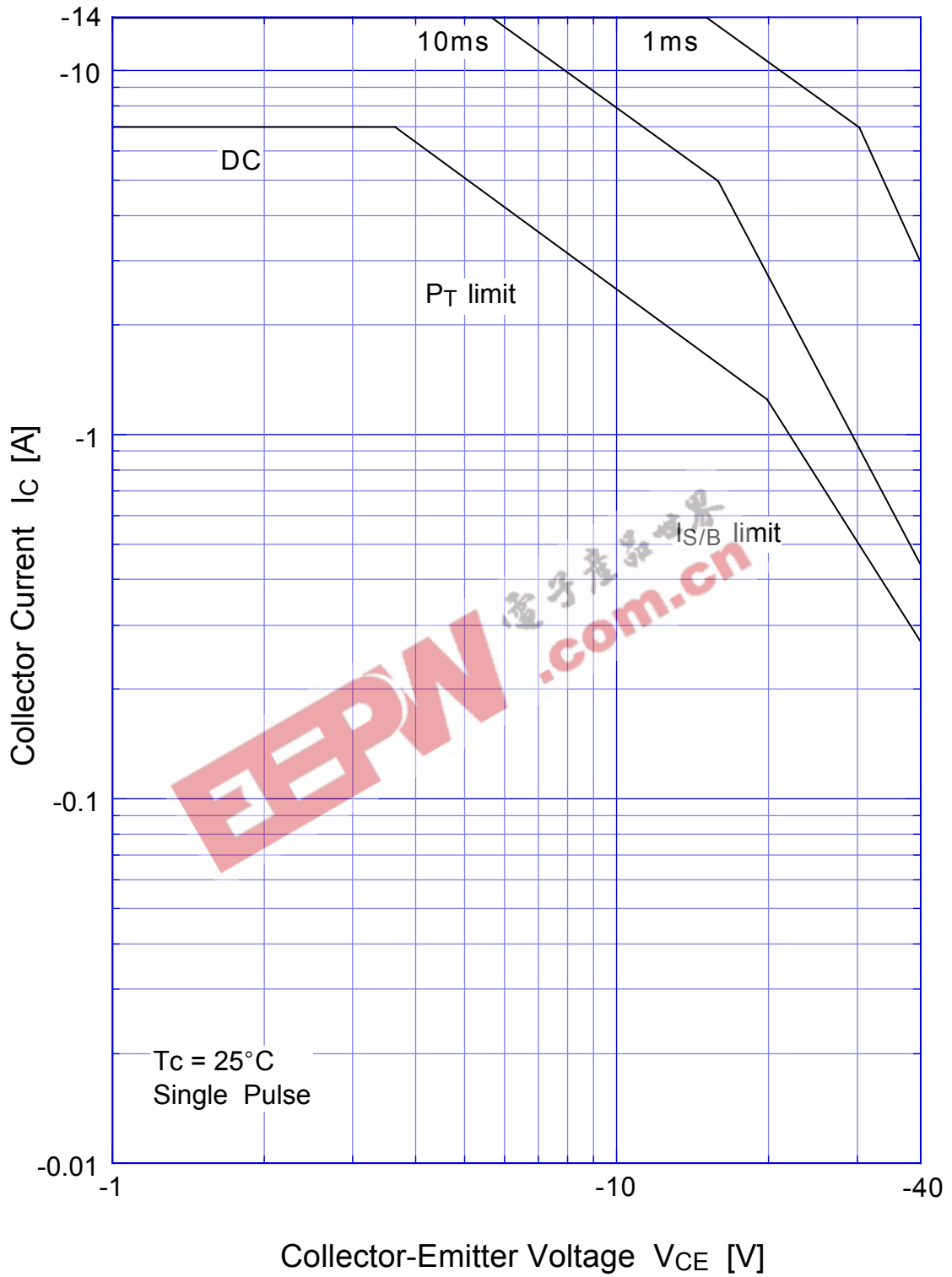

## 2SA1598 Collector Current Derating

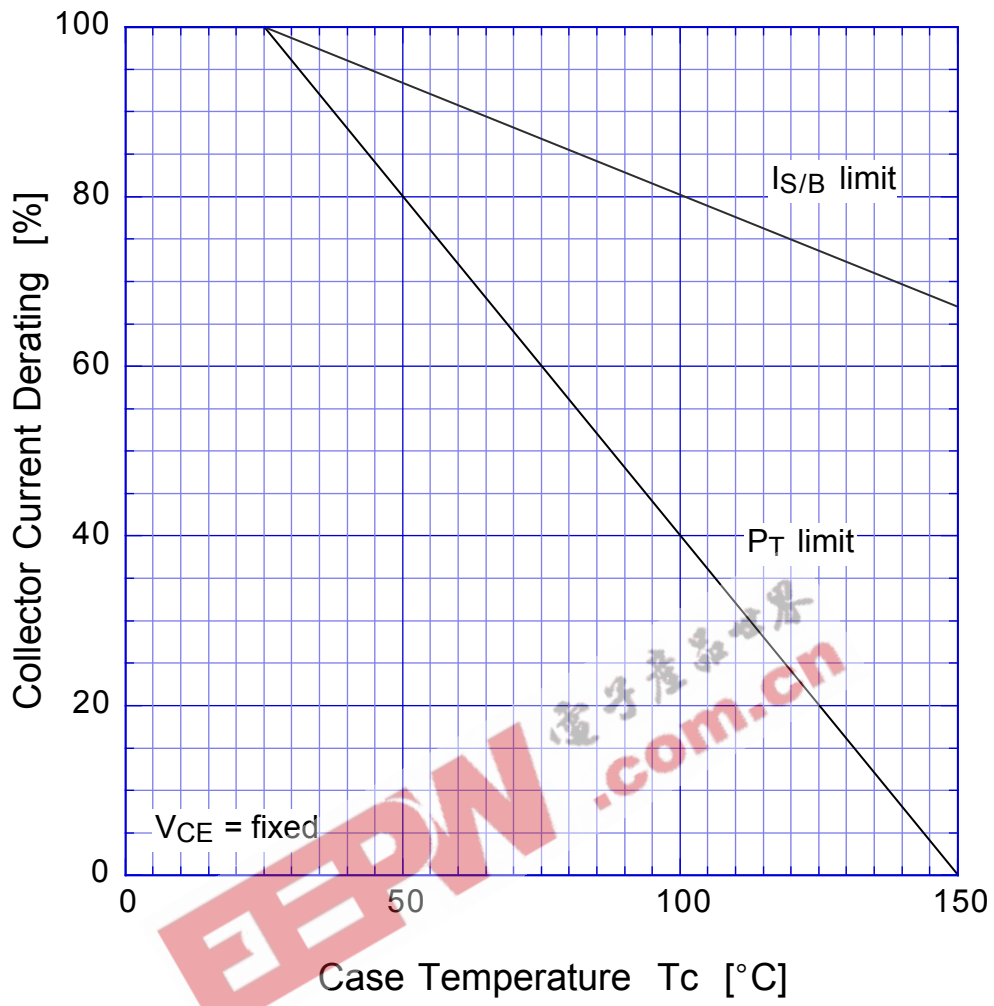



# 2SA1598

# Reverse Bias SOA

