

2SA1859/1859A

Silicon PNP Epitaxial Planar Transistor (Complement to type 2SC4883/A)

Application : Audio Output Driver and TV Velocity-modulation

Absolute maximum ratings (Ta=25°C)

Symbol	2SA1859	2SA1859A	Unit
V _{CB0}	-150	-180	V
V _{CE0}	-150	-180	V
V _{EBO}	-6		V
I _c	-2		A
I _B	-1		A
P _c	20(T _c =25°C)		W
T _j	150		°C
T _{stg}	-55 to +150		°C

Electrical Characteristics (Ta=25°C)

Symbol	Conditions	2SA1859	2SA1859A	Unit
I _{CB0}	V _{CB} =	-10max		μA
I _{EBO}	V _{EB} =-6V	-10max	-180	μA
V _{(BR)CEO}	I _c =-10mA	-150min	-180min	V
h _{FE}	V _{CE} =-10V, I _c =-0.7A	60 to 240		
V _{CE(sat)}	I _c =-0.7A, I _B =-70mA	-1.0max		V
f _r	V _{CE} =-12V, I _E =0.7A	60typ		MHz
COB	V _{CB} =-10V, f=1MHz	30typ		pF

Typical Switching Characteristics (Common Emitter)

V _{CC} (V)	R _L (Ω)	I _c (A)	V _{BB1} (V)	V _{BB2} (V)	I _{B1} (mA)	I _{B2} (mA)	t _{on} (μs)	t _{stg} (μs)	t _r (μs)
-20	20	-1	-10	5	-100	100	0.5typ	1.0typ	0.5typ

External Dimensions FM20(TO220F)

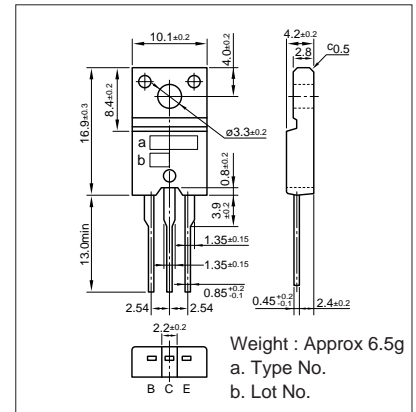

I_c-V_{CE} Characteristics (Typical)

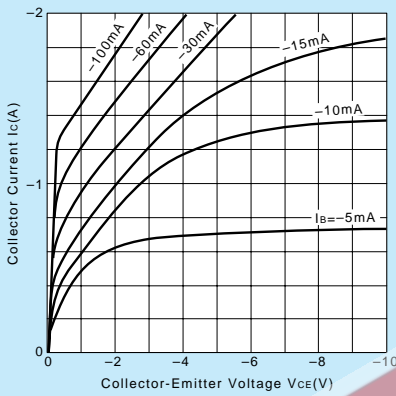

V_{CE(sat)}-I_B Characteristics (Typical)

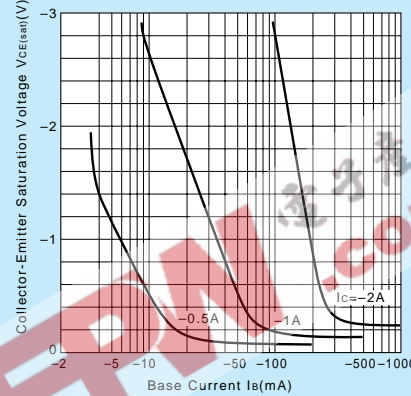

I_c-V_{BE} Temperature Characteristics (Typical)

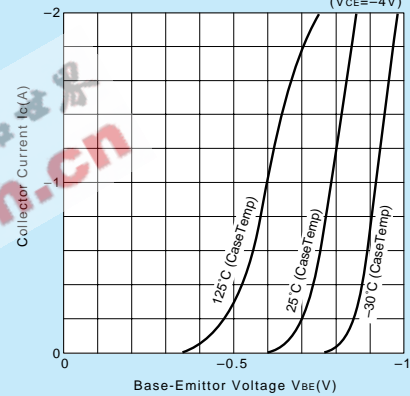

h_{FE}-I_c Characteristics (Typical)

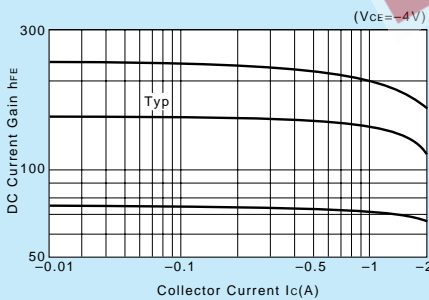

h_{FE}-I_c Temperature Characteristics (Typical)

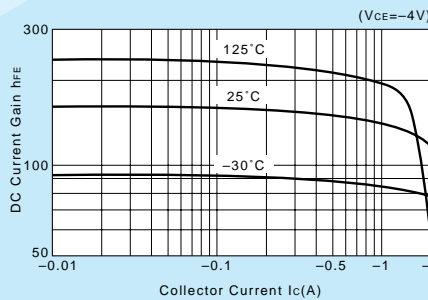

θ_{j-a}-t Characteristics

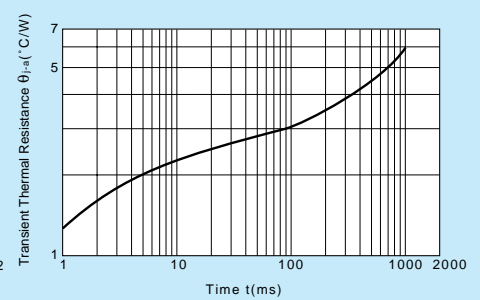

f_r-I_E Characteristics (Typical)

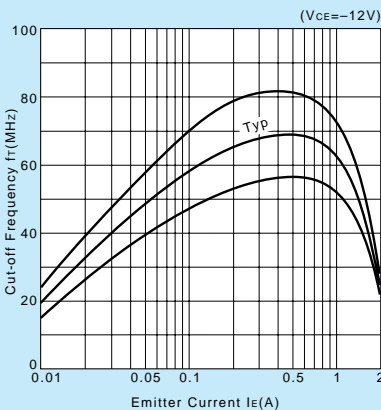

Safe Operating Area (Single Pulse)

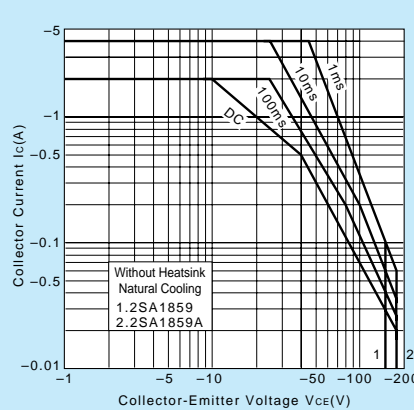

P_c-T_a Derating

