

# Transistors for TV Display Video Output Use

Features \*Excellent HF characteristic. \*Small reverse transfer capacitance. \*Complementary PNP and NPN types.  
\*Adoption of MBIT, FBST processes. \*Highly resistant to dielectric breakdown.

Case Outline (unit:mm)

SANYO-CP

1:Base, 2:Emitter, 3:Collector

## General-Purpose Type (※: Tc=25°C) For PNP, (-) sign is omitted.

Type No.	Package	Absolute Maximum Ratings/Ta=25°C				Electrical Characteristics/Ta=25°C					
		V <sub>CEO</sub> (V)	V <sub>CE0</sub> (V)	I <sub>C</sub> (A)	P <sub>C</sub> (W)	f <sub>T</sub> typ (MHz)	V <sub>CE</sub> / I <sub>C</sub> (V/mA)	C <sub>ob</sub> typ (PF)	C <sub>re</sub> (PF)	V <sub>CB</sub> (V)	h <sub>FE</sub>
2SC2857	NP	180	180	50m	0.5	min50	30 / 10	4	-	10	40 ~ 320
2SA1689/2SC4449		300	300	50m	0.6	70	30 / 10	2.4/1.5	1.5/1	30	100 ~ 320
2SC5291	FLP	180	160	1.5	1.5	120	10 / 50	14	-	10	100 ~ 400
2SC4075	TO-220ML	300	300	0.2	※10	min50	30 / 10	5.3	-	50	40 ~ 200

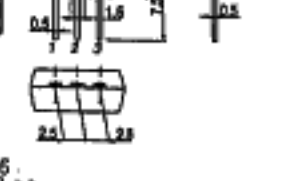
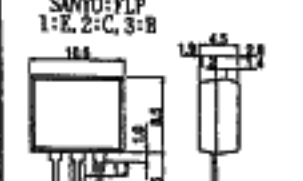
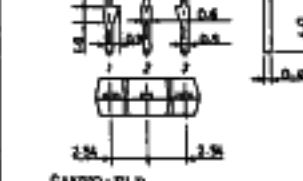
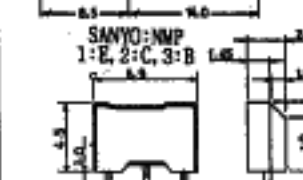
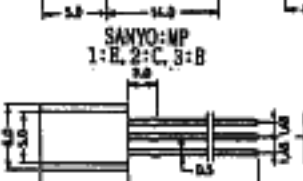
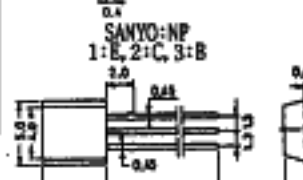
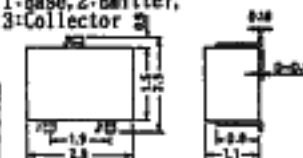

## High-Definition CRT Display Use

2SA1580/2SC4104	CP	70	60	50m	0.2	700	10 / 10	1.7/1.3	1.3/1	10	60 ~ 270
2SA1433/2SC3504	NP	200	200	0.1	1.0	150	30 / 10	2.6/1.7	1.7/1.2	30	40 ~ 320
2SA1370/2SC3467											
2SA1371/2SC3468	MNP	300	300	0.1	1.0	150	30 / 10	3.1/2.6	2.3/1.8	30	40 ~ 320
2SA1710/2SC4490											
2SA1787/2SC4650	FLP	200	200	0.1	1.0	150	30 / 10	2.6/1.7	1.7/1.2	30	40 ~ 320
2SA1828/2SC4732											
2SA1829/2SC4733	TO-126	300	300	0.1	1.3	150	30 / 10	3.1/2.6	2.3/1.8	30	60 ~ 320
2SC4884											
2SA1352/2SC3416	TO-126	200	200	0.1	1.2	70	30 / 10	2.6/1.7	1.7/1.2	30	40 ~ 320
2SA1353/2SC3417											
2SA1380/2SC3502	TO-126ML	200	200	0.1	1.2	150	30 / 10	2.6/1.7	1.7/1.2	30	40 ~ 320
2SA1381/2SC3503											
2SA1478/2SC3788	TO-126ML	200	200	0.1	1.3	150	30 / 10	2.6/1.7	1.7/1.2	30	40 ~ 320
2SA1479/2SC3789											
2SA1480/2SC3790	TO-220	300	300	0.1	1.5	150	30 / 10	3.1/2.6	2.3/1.8	30	40 ~ 320
2SC4217											
2SC4378	TO-220	300	300	0.2	1.5	70	10 / 10	3.5	-	50	40 ~ 200
2SC4188											
2SC4188	TO-220	200	200	0.1	※10	150	30 / 10	1.8	1.3	30	40 ~ 320

Underlined type Nos. are before mass production.

\*Classification by h<sub>FE</sub>

40	C	80	60	D	120	100	E	200	180	F	320
(CP type)			60	3	120	90	4	180	135	5	270

2SC5291(100~400)

100	R	200	140	S	280	200	T	400
-----	---	-----	-----	---	-----	-----	---	-----

\*Equivalent Circuit for Video Output Use

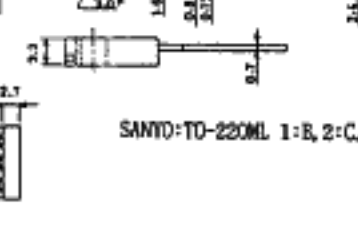
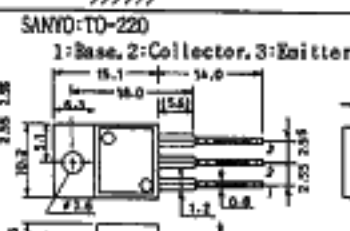
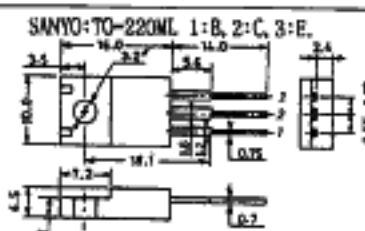
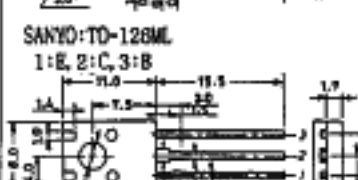
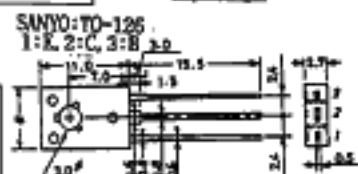
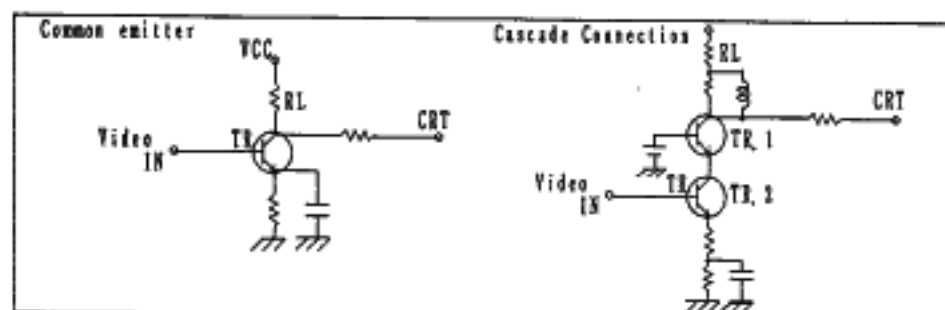

These specifications are subject to change without notice.

# SANYO Discrete Device Package Outlines(unit:mm)

## Small-Signal Transistors

Outlines name	SSFP, SMCP, MCP, MCP4/5, CP, CP4/5/5, CPB3/5/5, PCP, PCP4/5, XP5/5, TP, TP-FA, MFP6, TSSOP8, SOP8, SPA, NP, MP, NMP, FLP, TO-126, TO-126ML, TO-126LP
---------------	--

## Large-Signal Transistors

Outlines name	ZP, SMP, SMP-PD, TO-220, TO-220C1, TO-220ML, TO-220FI (LS), TO-220MF, TO-3PB, TO-3PML, TO-3PBL, TO-3JWL
---------------	---

### SANYO Transistor Package Name List.

#### Surface Mount Types

SSFP	Super Small Flat Package
SMCP	Super Mini Chip Pack.
MCP	Mini Chip Pack.
MCP4/5	Mini Chip Pack. (PH type)
CP	Chip Pack.
CP5/5	Chip Pack. (FC type)
CPB3/5/5	Chip Pack high-power
PCP	Power Chip Pack.
PCP4/5	Power Chip Pack. (FP type)
NP	Chip Pack. (FK type)
TSSOP8	(FTS, FTD type)
SOP8	(FW, FSS type)
TP-FA	Tiny Package
SMP-PD	For large signal
ZP	For large signal

#### Lead Types

ML:No insulating needed.

NMP	New NP
FLP	Full Mold Large Package
TO-126LP	Large-Power
TO-126ML	Micaless
TO-220, 220ML	ML:Micaless type
TO-220C1	CI:Compact Isolation
TO-220FI (LS)	Full Isolation (leads short type)
TO-220MF	Mini Fin Short fin type.
TO-3PB, 3PML	Bushless, ML:Micaless
TO-3PBL	Micaless
TO-3PBL	Bushless Large
TO-3JWL	Jumbo Micaless

PB, BL:no insulating needed.

### Notes

#### Nomenclature of house NOs.

The first several letters of the type Nos. of the FSS, FTD, FW, FTS, FC, FP, FB, series mean:

- 1'st F : Packages for complex type devices. (CP5/5, MCP4/5, PCP4/5, XP5/5, SOP8, TSSOP8)
- 2'nd S: SOP8 package
- 2'nd W: Double chips
- 2'nd T: TSSOP8 package
- 2'nd C: CP5/5 package
- 2'nd P: PCP4/5 package
- 2'nd X: XP5/5 package
- 2'nd D: Dual type
- 2'nd H: Ultra high freq. type
- 3'rd S: Single

Type Nos. of 1XX or 1XXX are p-channel types.  
Type Nos. of 2XX or 2XXX are N-channel types.  
XP package is excluded.

\*How to name CPB3/5 devices. Package name followed by 1, 2, 3 or 4 and then tow-digit consecutive Nos. Figures following the package names mean: 1:P-NP Tr, 2:NPN Tr, 3:P-ch MOSFET, 4:N-ch MOSFET.

### Surface Mount Type Outlines(JEDEC and EIAJ name are in parentheses.)

#### Top View Pin Nos. of top view are CAD register Nos. Bottom side : Heat sink side.

SANYO:SSFP	SANYO:SMCP(SC-75A)	SANYO:MCP(SC-70), MCP4(SC-82, A), MCP5
Device weight:0.002g	Device weight:0.003g	Device weight:0.006g, 0.007g, 0.007g

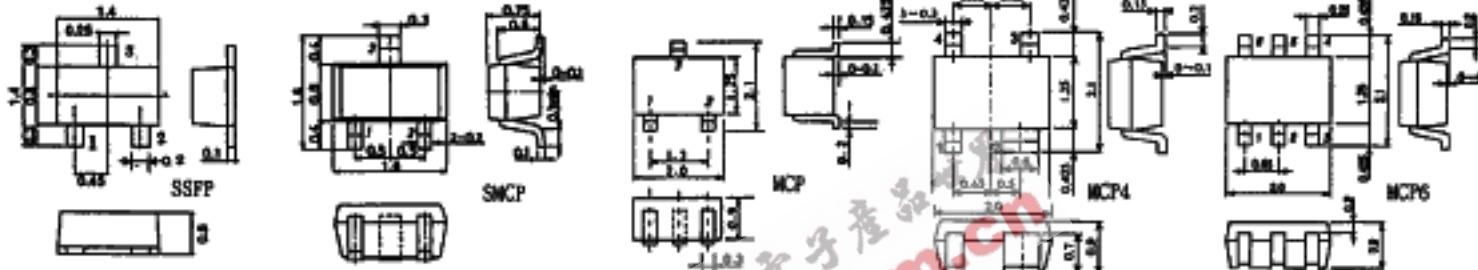

SANYO:CP(SC-69, TO-236)	SANYO:CP4, CP5, CP6(SC-61, SC-74A, SC-74, SOT143)	SANYO:CPB3, CPB5
Device weight:0.013g	Device weight:0.013g, 0.014g, 0.015g	Device weight:0.013g, 0.015g



SANYO:CPB6	SANYO:PCP, PCP4/5(SC-62, SOT89) Bottom View	SANYO:XP5 Bottom View
Device weight:0.015g	Device weight:0.058g, 0.052g	Device weight:0.062g

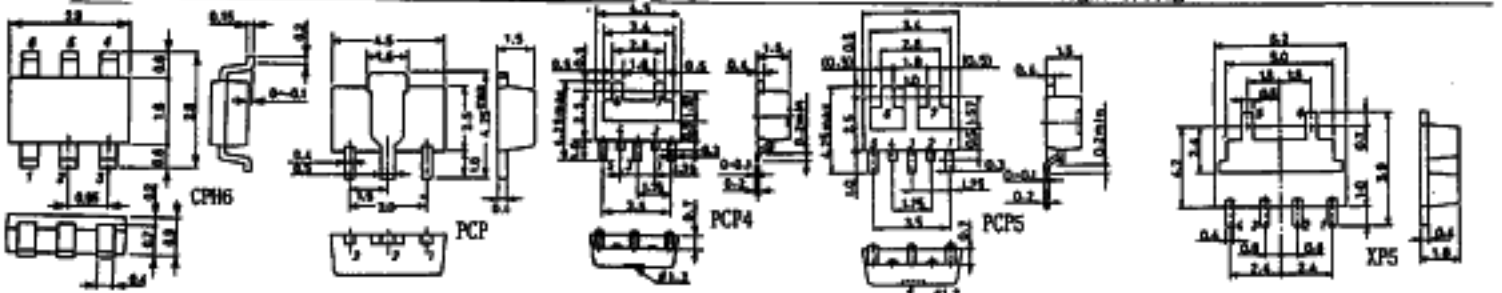

SANYO:XP5 Bottom View	SANYO:MFP6	SANYO:SOP8	SANYO:TSSOP8
Device weight:0.062g	Device weight:0.089g	Device weight:0.093g	Device weight:0.04g

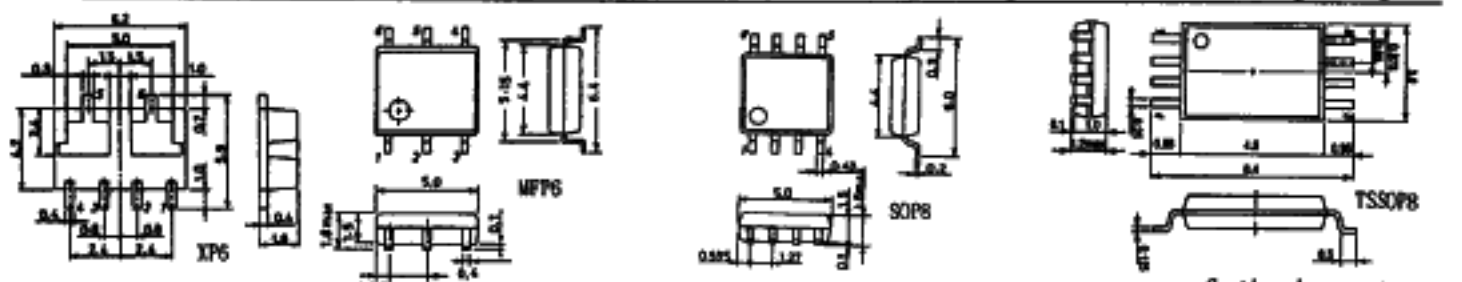

Continued on next page

# SANYO Discrete Device Package Outlines (unit:mm)

o/c Surface Mount Type Outlines (JEDEC and EIAJ name are in parentheses.)

Top View Pin Nos. of top view are CAD register Nos. Bottom side: Heat sink side.

SANYO:TP, TP-FA(SC-64, SC-63, TO-251)

Device weight:0.315g, 0.282g

SANYO:SNP, SNP-YD(forming type)(SC-83)

Device weight:1.4g

SANYO:ZP

Device weight:0.62g

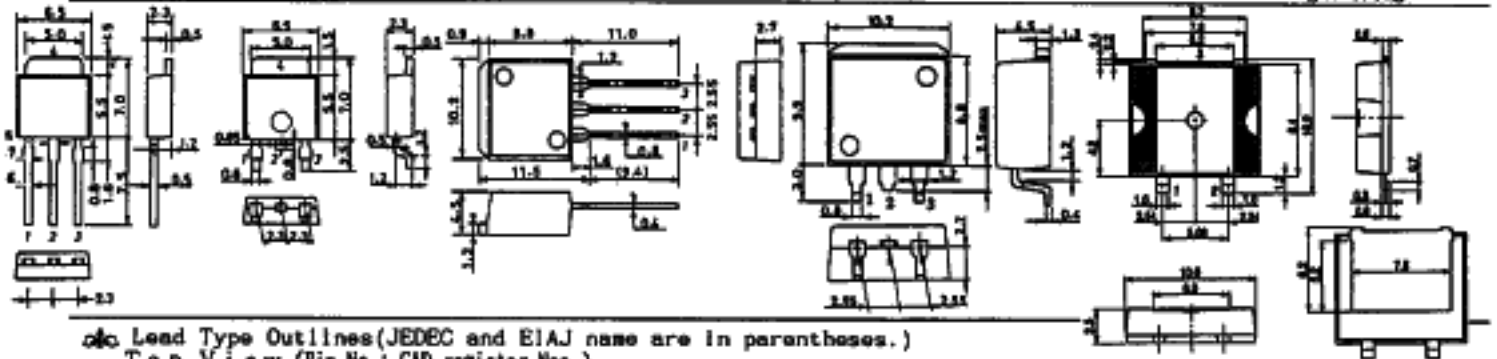

o/c Lead Type Outlines (JEDEC and EIAJ name are in parentheses.)

Top View (Pin No.: CAD register Nos.)

SANYO:SPA(TO-18, TO-39)

Device weight:0.098g

SANYO:NP(SC-43A, TO-92, SOT-54)

Device weight:0.269g

SANYO:MP(SC-51, TO-226)

Device weight:0.578g

SANYO:NMP(SC-71)

Device weight:0.21g, AN use:0.275g

SANYO:FLP

Device weight:1.1g

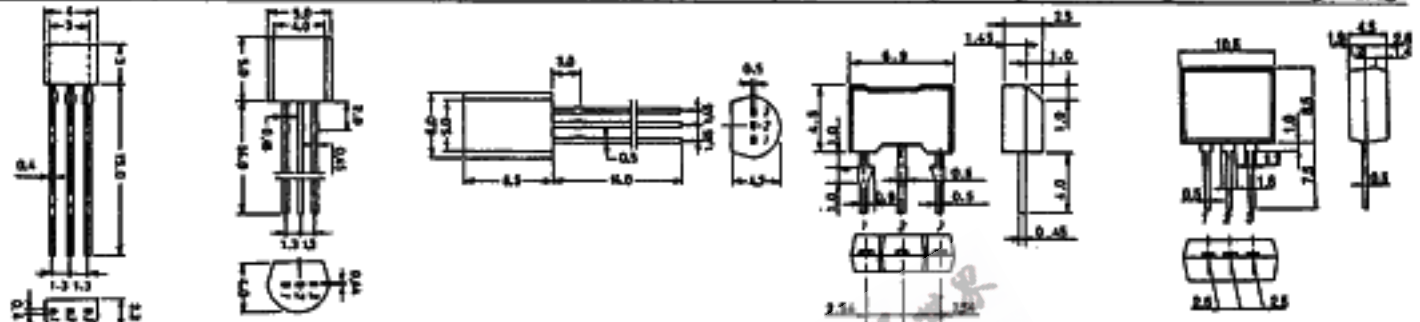

SANYO:TO-126(TO-126, TO-225, SOT-32), TO-126LP, TO-126ML(SOT-82)

Device weight:0.675g, 0.7g, 0.97g

SANYO:TO-220AR, AR(SC-45, 46, TO-220AA)

Device weight:1.9g

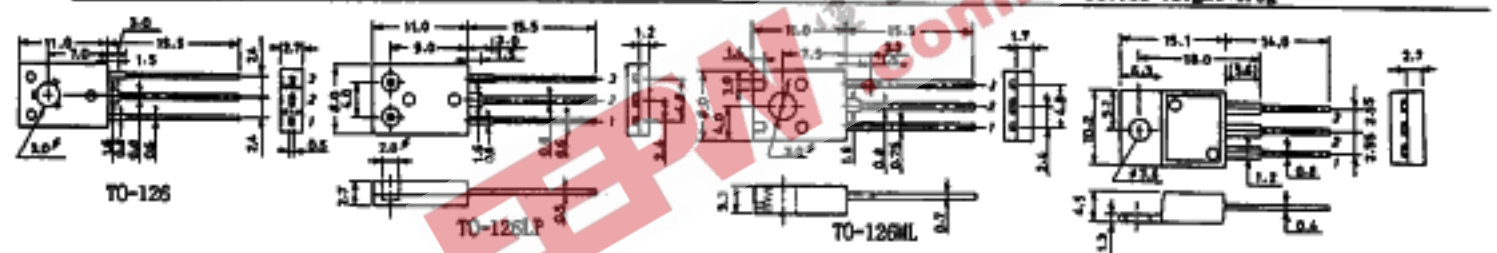

SANYO:TO-220C1

Device weight:1.75g

SANYO:TO-220M(SC-67, SOT-186)

Device weight:1.9g

SANYO:TO-220F(LS)(SC-67, SOT-189)

Device weight:1.8g

SANYO:TO-220MF

Device weight:1.4g

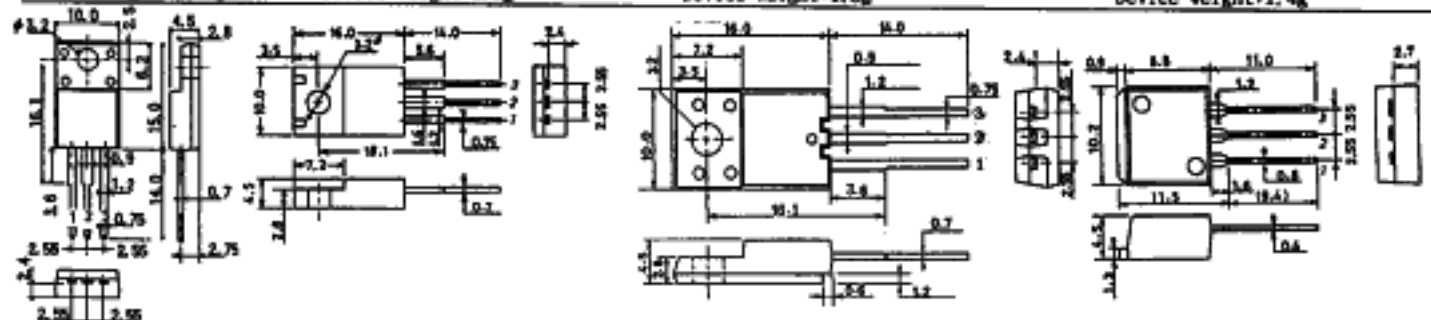

SANYO:TO-3PB(SC-65, TO-218)

Device weight:5.8g

SANYO:TO-3PML(180WATT218)

Device weight:5.3g

SANYO:TO-3PBL(TO-247)

Device weight:9.2g

SANYO:TO-3JML

Device weight:9.2g

