

# 2SA1667/1668

Silicon PNP Epitaxial Planar Transistor (Complement to type 2SC4381/4382)

Application : TV Vertical Output, Audio Output Driver and General Purpose

### Absolute maximum ratings (Ta=25°C)

Symbol	2SA1667	2SA1668	Unit
V <sub>CB0</sub>	-150	-200	V
V <sub>CE0</sub>	-150	-200	V
V <sub>EB0</sub>	-6		V
I <sub>c</sub>	-2		A
I <sub>b</sub>	-1		A
P <sub>c</sub>	25(T <sub>c</sub> =25°C)		W
T <sub>j</sub>	150		°C
T <sub>stg</sub>	-55 to +150		°C

### Electrical Characteristics (Ta=25°C)

Symbol	Conditions	2SA1667	2SA1668	Unit
I <sub>cB0</sub>	V <sub>CB</sub> =	-10max	-10max	μA
I <sub>EB0</sub>	V <sub>EB</sub> =-6V	-10max		μA
V <sub>(BR)CEO</sub>	I <sub>c</sub> =-25mA	-150min	-200min	V
h <sub>FE</sub>	V <sub>CE</sub> =-10V, I <sub>c</sub> =-0.7A	60min		
V <sub>CE(sat)</sub>	I <sub>c</sub> =-0.7A, I <sub>b</sub> =-0.07A	-1.0max		V
f <sub>r</sub>	V <sub>CE</sub> =-12V, I <sub>e</sub> =0.2A	20typ		MHz
COB	V <sub>CB</sub> =-10V, f=1MHz	60typ		pF

### External Dimensions FM20 (TO220F)

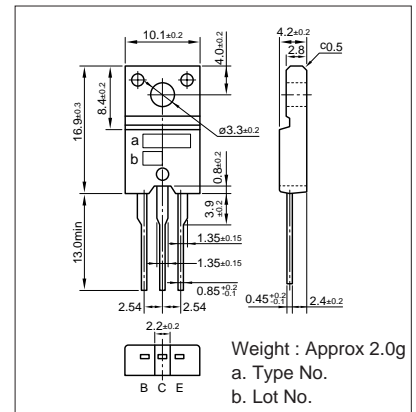

### Typical Switching Characteristics (Common Emitter)

V <sub>CC</sub> (V)	R <sub>L</sub> (Ω)	I <sub>c</sub> (A)	V <sub>BB1</sub> (V)	V <sub>BB2</sub> (V)	I <sub>b1</sub> (mA)	I <sub>b2</sub> (mA)	t <sub>on</sub> (μs)	t <sub>stg</sub> (μs)	t <sub>f</sub> (μs)
-20	20	-1	-10	5	-100	100	0.4typ	1.5typ	0.5typ

I<sub>c</sub>-V<sub>CE</sub> Characteristics (Typical)

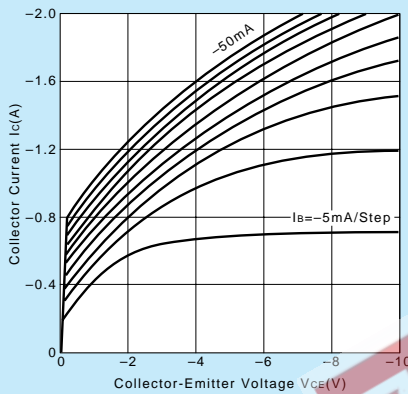

V<sub>CE(sat)</sub>-I<sub>b</sub> Characteristics (Typical)

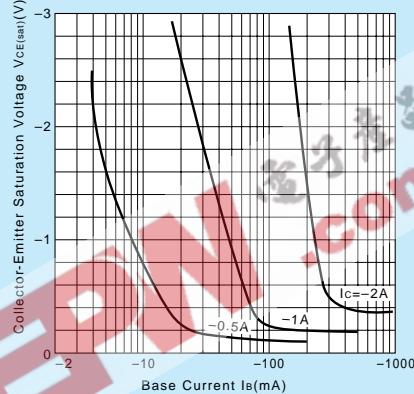

I<sub>c</sub>-V<sub>BE</sub> Temperature Characteristics (Typical)

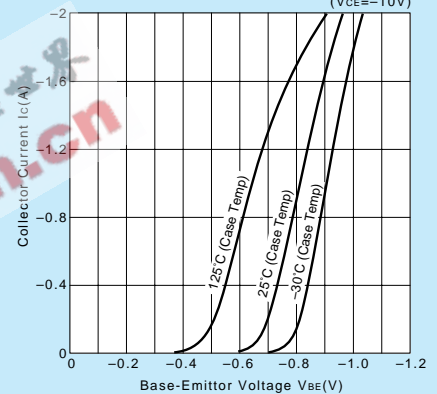

h<sub>FE</sub>-I<sub>c</sub> Characteristics (Typical)

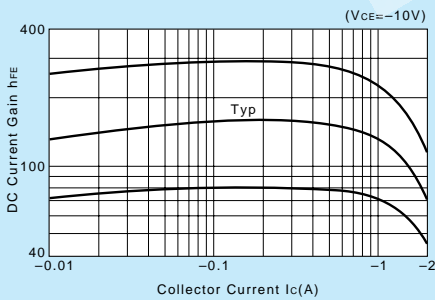

h<sub>FE</sub>-I<sub>c</sub> Temperature Characteristics (Typical)

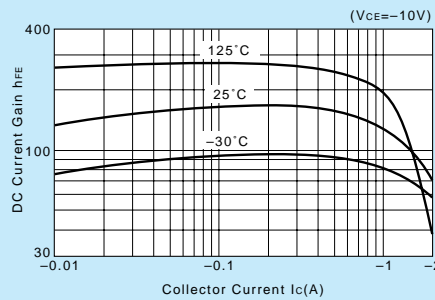

θ<sub>j-a</sub>-t Characteristics

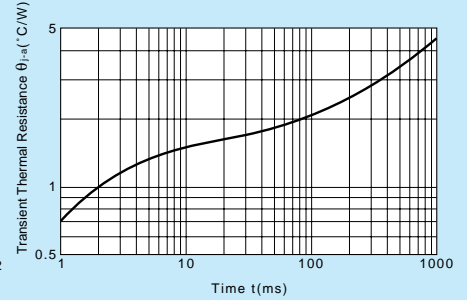

f<sub>r</sub>-I<sub>e</sub> Characteristics (Typical)

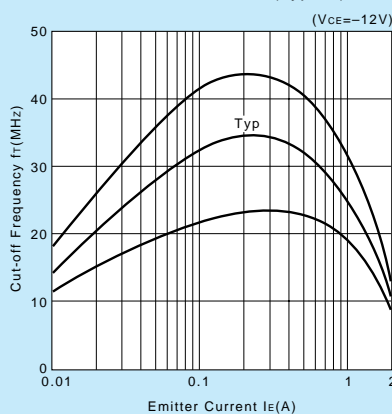

Safe Operating Area (Single Pulse)

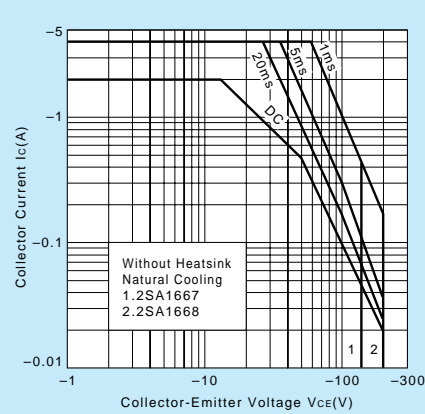

P<sub>c</sub>-T<sub>a</sub> Derating

