



2SC1815

NPN EPITAXIAL SILICON TRANSISTOR

AUDIO FREQUENCY AMPLIFIER HIGH FREQUENCY OSC NPN TRANSISTOR

FEATURES

- * Collector-Emitter voltage:
BV_{CEO}=50V
- * Collector current up to 150mA
- * High h_{FE} linearity
- * Complimentary to UTC 2SA1015

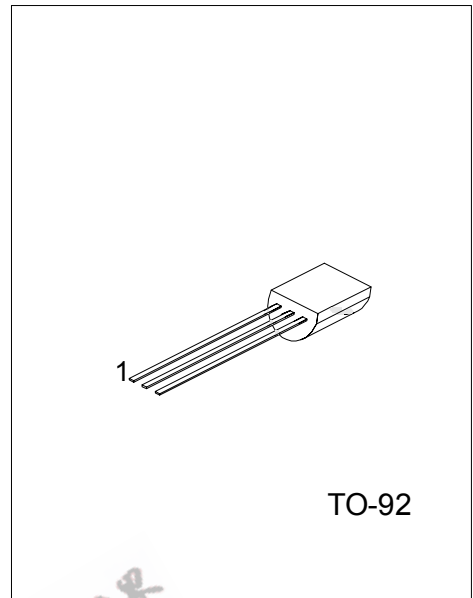

*Pb-free plating product number: 2SC1815L

ORDERING INFORMATION

Order Number		Package	Pin Assignment			Packing
Normal	Lead Free Plating		1	2	3	
2SC1815-x-T92-A-B	2SC1815L-x-T92-A-B	TO-92	E	C	B	Tape Box
2SC1815-x-T92-A-K	2SC1815L-x-T92-A-K	TO-92	E	C	B	Bulk

<p>2SC1815L-x-T92-A-B</p>	<p>(1)Packing Type (2)Pin Assignment (3)Package Type (4)Rank (5)Lead Plating</p> <p>(1) B: Tape Box, K: Bulk (2) refer to Pin Assignment (3) T92: TO-92 (4) x: refer to Classification of h_{FE1} (5) L: Lead Free Plating, Blank: Pb/Sn</p>
---------------------------	--

2SC1815

NPN EPITAXIAL SILICON TRANSISTOR

■ ABSOLUTE MAXIMUM RATING (Ta=25°C, unless otherwise specified)

PARAMETER	SYMBOL	RATINGS	UNIT
Collector-base voltage	V _{CBO}	60	V
Collector-emitter voltage	V _{CEO}	50	V
Emitter-base voltage	V _{EBO}	5	V
Collector current	I _C	150	mA
Base current	I _B	50	mA
Collector dissipation(Ta=25°C)	P _C	400	mW
Junction Temperature	T _J	+125	°C
Storage Temperature	T _{STG}	-55 ~ +125	°C

Note Absolute maximum ratings are those values beyond which the device could be permanently damaged.

Absolute maximum ratings are stress ratings only and functional device operation is not implied.

■ ELECTRICAL CHARACTERISTICS (Ta=25°C, unless otherwise specified)

PARAMETER	SYMBOL	TEST CONDITIONS	MIN	TYP	MAX	UNIT
Collector Cut-off Current	I _{CBO}	V _{CB} =60V, I _E =0			100	nA
Emitter Cut-off Current	I _{EBO}	V _{EB} =5V, I _C =0			100	nA
Collector-Emitter Saturation Voltage	V _{CE(SAT)}	I _C =100mA, I _B =10mA		0.1	0.25	V
Base-Emitter Saturation Voltage	V _{BE(SAT)}	I _C =100mA, I _B =10mA			1.0	V
DC Current Gain(note)	h _{FE1}	V _{CE} =6V, I _C =2mA	120		700	
	h _{FE2}	V _{CE} =6V, I _C =150mA	25			
Current Gain Bandwidth Product	f _T	V _{CE} =10V, I _C =50mA	80			MHz
Output Capacitance	C _{ob}	V _{CB} =10V, I _E =0, f=1MHz		2.0	3.0	pF
Noise Figure	NF	I _C =-0.1mA, V _{CE} =6V R _G =10kΩ, f=100Hz		1.0	1.0	dB

■ CLASSIFICATION OF h_{FE1}

RANK	Y	GR	BL
RANGE	120-240	200-400	350-700

■ TYPICAL CHARACTERISTICS

Fig.1 Static characteristics

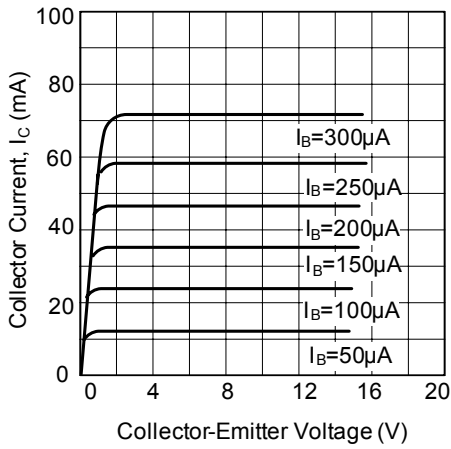

Fig.2 DC current Gain

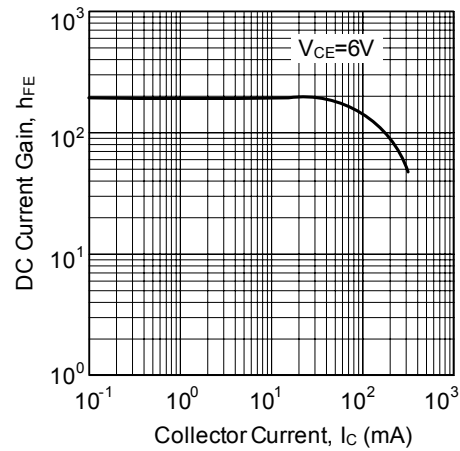

Fig.3 Base-Emitter on Voltage

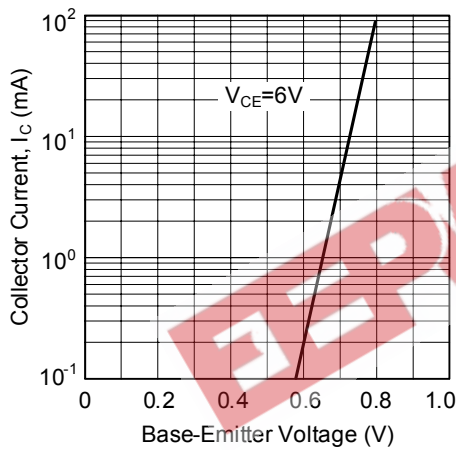

Fig.4 Saturation Voltage

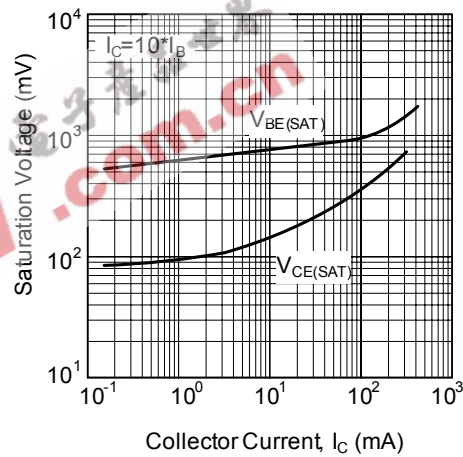

Fig.5 Current Gain-Bandwidth Product

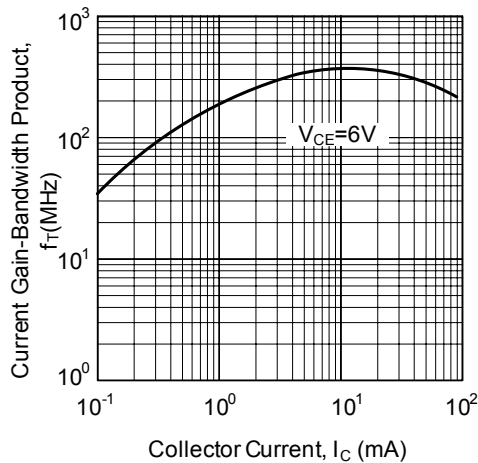
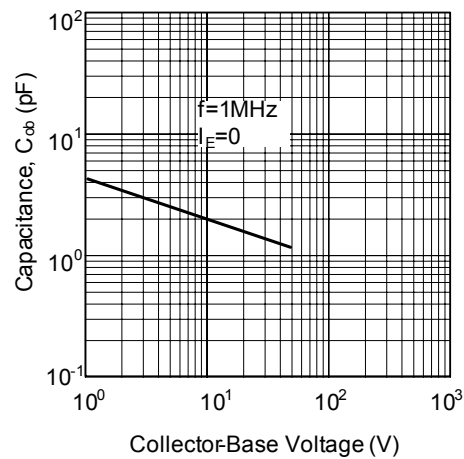

Fig.6 Collector Output Capacitance



EEPW 電子產品世界
.com.cn

UTC assumes no responsibility for equipment failures that result from using products at values that exceed, even momentarily, rated values (such as maximum ratings, operating condition ranges, or other parameters) listed in products specifications of any and all UTC products described or contained herein. UTC products are not designed for use in life support appliances, devices or systems where malfunction of these products can be reasonably expected to result in personal injury. Reproduction in whole or in part is prohibited without the prior written consent of the copyright owner. The information presented in this document does not form part of any quotation or contract, is believed to be accurate and reliable and may be changed without notice.