



## 2SC2655

## NPN SILICON TRANSISTOR

POWER AMPLIFIER APPLICATIONS  
POWER SWITCHING APPLICATIONS

### FEATURES

- \*Low saturation voltage  
 $V_{CE(SAT)} = 0.5V$  (Max.)
- \*High speed switching time  
 $t_{stg} = 1.0\mu s$  (Typ.)

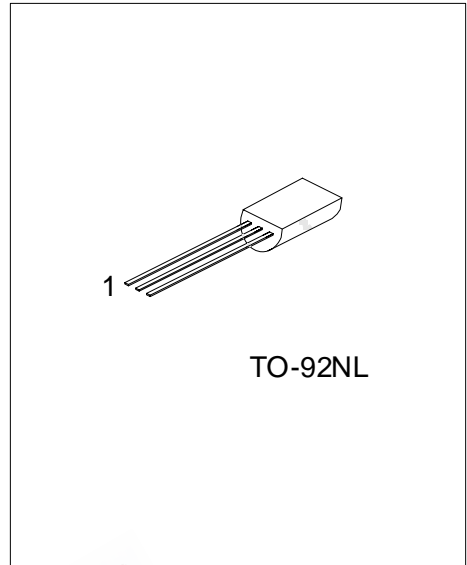

\*Pb-free plating product number: 2SC2655L

### ORDERING INFORMATION

Order Number		Package	Pin Assignment			Packing
Normal	Lead Free Plating		1	2	3	
2SC2655-x-T9N-B	2SC2655L-x-T9N-B	TO-92NL	E	C	B	Tape Box
2SC2655-x-T9N-K	2SC2655L-x-T9N-K	TO-92NL	E	C	B	Bulk
2SC2655-x-T9N-R	2SC2655L-x-T9N-R	TO-92NL	E	C	B	Tape Reel

<p>2C2655L-x-T9N-K</p> <p>(1) Packing Type (2) Package Type (3) Rank (4) Lead Plating</p>	<p>(1) B: Tape Box, K: Bulk, R: Tape Reel (2) T9N: TO-92NL (3) refer to Classification of <math>h_{FE(1)}</math> (4) L: Lead Free Plating, Blank: Pb/Sn</p>
---	---

■ ABSOLUTE MAXIMUM RATINGS ( Ta=25°C ,unless otherwise specified )

PARAMETER	SYMBOL	RATING	UNIT
Collector-Base Voltage	$V_{CBO}$	50	V
Collector-Emitter Voltage	$V_{CEO}$	50	V
Emitter-Base Voltage	$V_{EBO}$	5	V
Collector Current	$I_C$	2	A
Collector Current(Pulse)	$I_{cp}^*$	3	A
Base Current	$I_B$	0.5	A
Collector Power Dissipation	$P_C$	900	mW
Junction Temperature	$T_J$	150	°C
Storage Temperature	$T_{STG}$	-55 ~ +150	°C

Note: \* PW 16ms, Duty Cycle 50%.

1. Absolute maximum ratings are those values beyond which the device could be permanently damaged. Absolute maximum ratings are stress ratings only and functional device operation is not implied.

■ ELECTRICAL CHARACTERISTICS(Ta=25°C, unless otherwise specified)

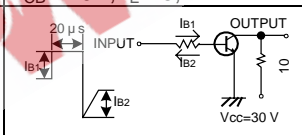
PARAMETER	SYMBOL	TEST CONDITIONS	MIN	TYP	MAX	UNIT
Collector Emitter Breakdown Voltage	$BV_{CEO}$	$I_C=10mA, I_B=0$	50			V
Collector Cut-off Current	$I_{CBO}$	$V_{CB}=50V, I_E=0$			1.0	$\mu A$
Emitter Cut-off Current	$I_{EBO}$	$V_{EB}=5V, I_C=0$			1.0	$\mu A$
DC Current Gain	$h_{FE(1)}$	$V_{CE}=2V, I_C=0.5A$	70		240	
	$h_{FE(2)}$	$V_{CE}=2V, I_C=1.5A$	40			
Collector-Emitter Saturation Voltage	$V_{CE(SAT)}$	$I_C=1A, I_B=0.05A$			0.5	V
Base- Emitter Saturation Voltage	$V_{BE(SAT)}$	$I_C=1A, I_B=0.05A$			1.2	V
Transition Frequency	$f_T$	$V_{CE}=2V, I_C=0.5A$		100		MHz
Collector Output Capacitance	$C_{ob}$	$V_{CB}=10V, I_E=0, f=1MHz$		30		pF
Switching Time(Turn-on Time)	$t_{ON}$	 $I_{B1} = -I_{B2} = 0.05A$ DUTY CYCLE 1%		0.1		$\mu S$

■ CLASSIFICATION OF  $h_{FE(1)}$

RANK	O	Y
RANGE	70-140	120-240

## TYPICAL CHARACTERISTICS

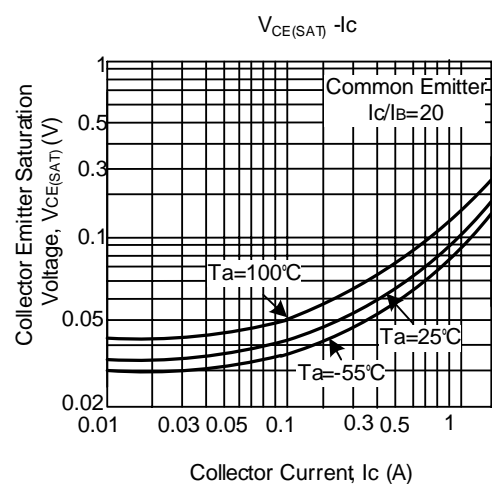
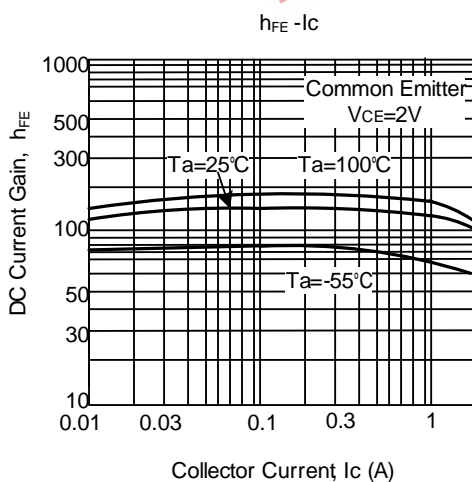
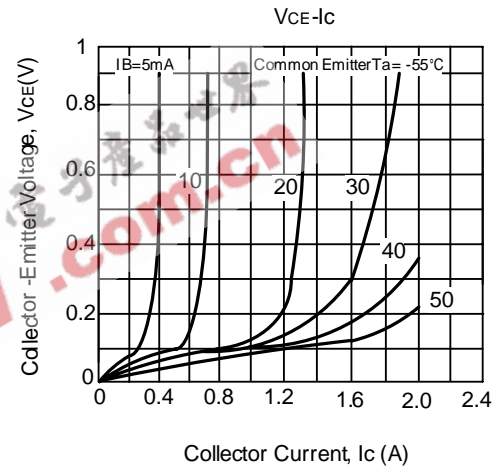
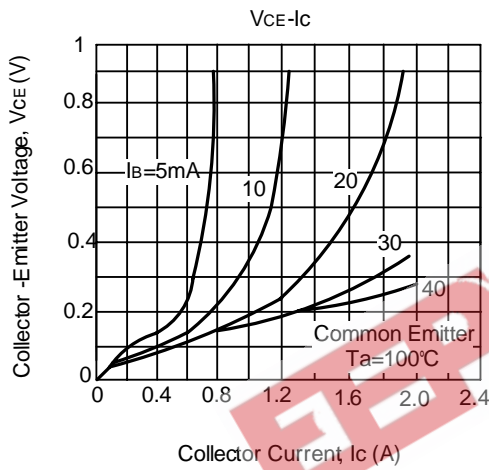
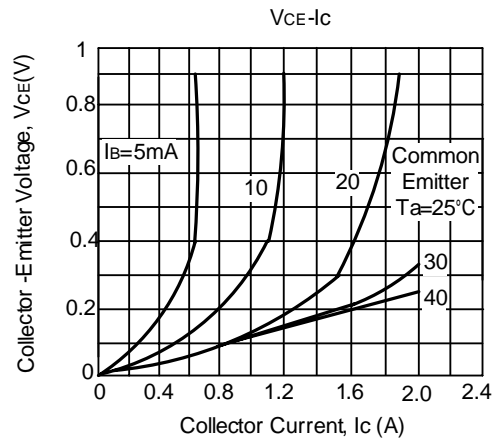
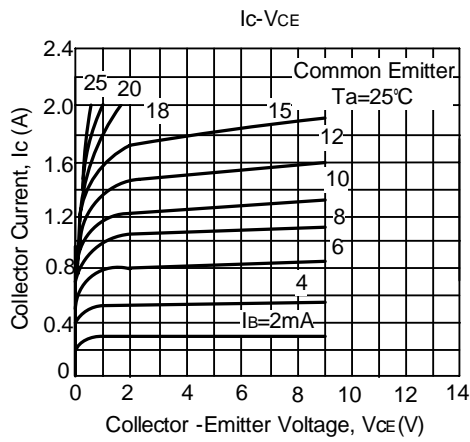

## TYPICAL CHARACTERISTICS(Cont.)

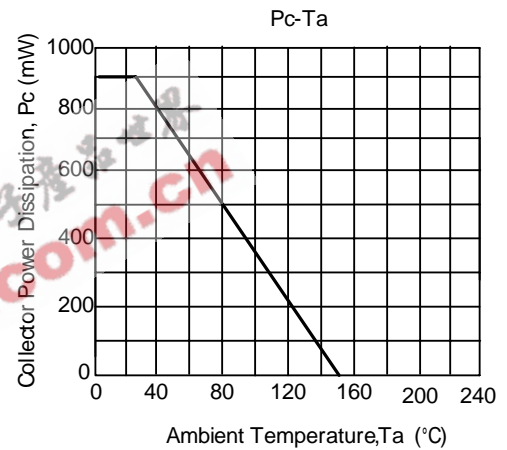
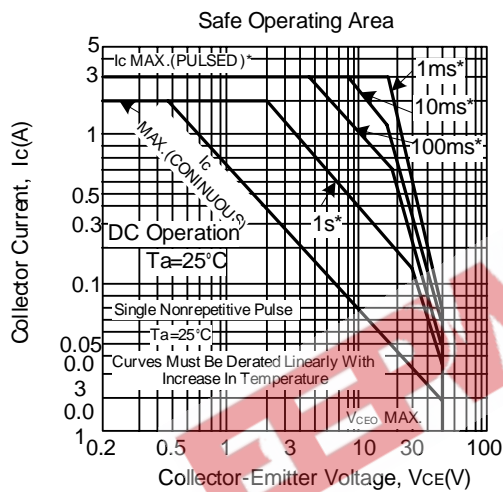
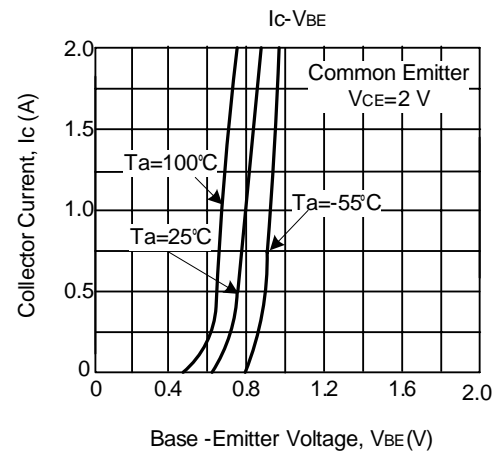
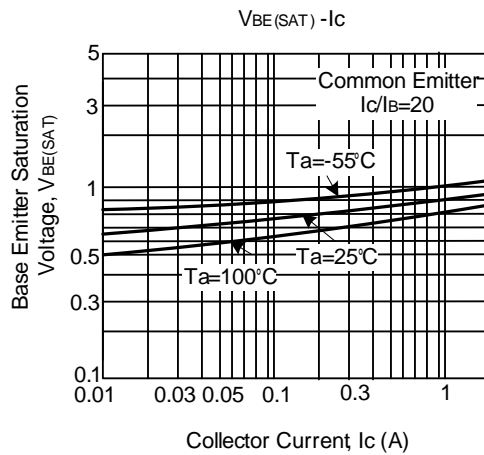

UTC assumes no responsibility for equipment failures that result from using products at values that exceed, even momentarily, rated values (such as maximum ratings, operating condition ranges, or other parameters) listed in products specifications of any and all UTC products described or contained herein. UTC products are not designed for use in life support appliances, devices or systems where malfunction of these products can be reasonably expected to result in personal injury. Reproduction in whole or in part is prohibited without the prior written consent of the copyright owner. The information presented in this document does not form part of any quotation or contract, is believed to be accurate and reliable and may be changed without notice.