



2SC2577

NPN PLANAR SILICON TRANSISTOR

**AUDIO POWER AMPLIFIER
DC TO DC CONVERTER**

- High Current Capability
- High Power Dissipation
- Complementary to 2SA1102

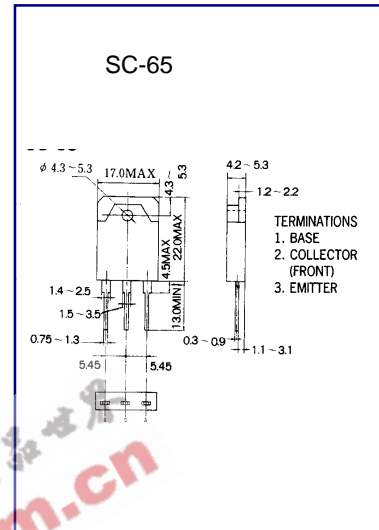

ABSOLUTE MAXIMUM RATING (Ta=25°C)

Characteristic	Symbol	Rating	Unit
Collector-Base Voltage	VCBO	160	V
Collector-Emitter Voltage	VCEO	120	V
Emitter-Base voltage	VEBO	6	V
Collector Current (DC)	IC	8	A
Collector Dissipation	PC	80	W
Junction Temperature	Tj	150	°C
Storage Temperature	Tstg	-55~150	°C

ELECTRICAL CHARACTERISTICS (Ta=25°C)

Characteristic	Symbol	Test Condition	Min	Typ	Max	Unit
Collector Base Breakdown Voltage	BVCBO	IC=5 mA IE=0	160			V
Collector Emitter Breakdown Voltage	BVCEO	IC=10 mA	120			V
Emitter Base Breakdown Voltage	BVEBO	RBE=∞	6			V
Collector Cutoff Current	ICBO	IE=5mA IC=0			0.1	mA
Emitter Cutoff Current	IEBO	VCB=60V IE=0			0.1	mA
*DC Current Gain	hFE1	VEB=4V IC=0	55		160	
DC Current Gain	hFE2	VCE=5V IC=1A	50			
Collector- Emitter Saturation Voltage	VCE(sat)	VCE=5V IC=3A IC=3A IB=0.3A			1.5	V