2SK1515, 2SK1516

Silicon N-Channel MOS FET

HITACHI

Application

High speed power switching

Features

- Low on-resistance
- High speed switching
- Low drive current
- Built-in fast recovery diode ($t_{rr} = 120 \text{ ns}$)
- Suitable for motor control, switching regulator, DC-DC converter

Outline

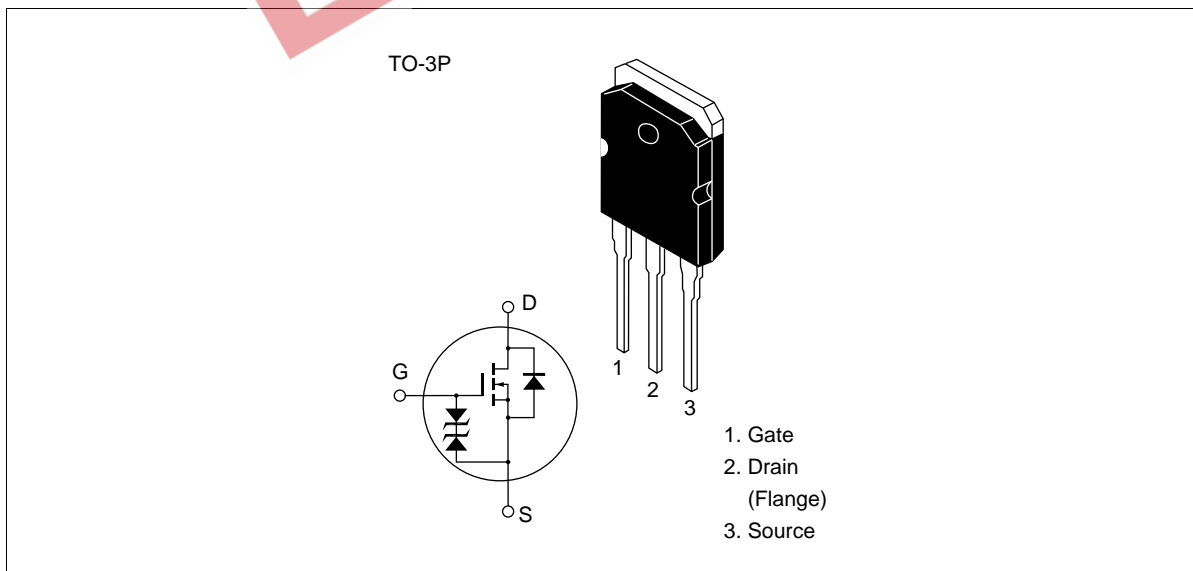

2SK1515, 2SK1516

Absolute Maximum Ratings (Ta = 25°C)

Item		Symbol	Ratings	Unit
Drain to source voltage	2SK1515	V_{DSS}	450	V
	2SK1516		500	
Gate to source voltage		V_{GSS}	±30	V
Drain current		I_D	10	A
Drain peak current		$I_{D(pulse)}^{*1}$	30	A
Body to drain diode reverse drain current		I_{DR}	10	A
Channel dissipation		P_{ch}^{*2}	100	W
Channel temperature		Tch	150	°C
Storage temperature		Tstg	-55 to +150	°C

Notes: 1. $PW \leq 10 \mu s$, duty cycle $\leq 1\%$

2. Value at $T_c = 25^\circ C$

EEPW 电子产品世界
.com.cn

2SK1515, 2SK1516

Electrical Characteristics (T_a = 25°C)

Item	Symbol	Min	Typ	Max	Unit	Test conditions
Drain to source breakdown voltage	2SK1515 $V_{(BR)DSS}$ 2SK1516	450	—	—	V	$I_D = 10 \text{ mA}, V_{GS} = 0$
Gate to source breakdown voltage	$V_{(BR)GSS}$	±30	—	—	V	$I_G = \pm 100 \mu\text{A}, V_{DS} = 0$
Gate to source leak current	I_{GSS}	—	—	±10	μA	$V_{GS} = \pm 25 \text{ V}, V_{DS} = 0$
Zero gate voltage drain current	2SK1515 I_{DSS} 2SK1516	—	—	250	μA	$V_{DS} = 360 \text{ V}, V_{GS} = 0$ $V_{DS} = 400 \text{ V}, V_{GS} = 0$
Gate to source cutoff voltage	$V_{GS(off)}$	2.0	—	3.0	V	$I_D = 1 \text{ mA}, V_{DS} = 10 \text{ V}$
Static Drain to source on state resistance	2SK1515 $R_{DS(on)}$ 2SK1516	—	0.6	0.8	Ω	$I_D = 5 \text{ A}, V_{GS} = 10 \text{ V}^{*1}$
Forward transfer admittance	$ y_{fs} $	4.0	7.0	—	S	$I_D = 5 \text{ A}, V_{DS} = 10 \text{ V}^{*1}$
Input capacitance	C_{iss}	—	1100	—	pF	$V_{DS} = 10 \text{ V}, V_{GS} = 0,$
Output capacitance	C_{oss}	—	310	—	pF	$f = 1 \text{ MHz}$
Reverse transfer capacitance	C_{rss}	—	50	—	pF	
Turn-on delay time	$t_{d(on)}$	—	15	—	ns	$I_D = 5 \text{ A}, V_{GS} = 10 \text{ V},$
Rise time	t_r	—	65	—	ns	$R_L = 6 \Omega$
Turn-off delay time	$t_{d(off)}$	—	95	—	ns	
Fall time	t_f	—	55	—	ns	
Body to drain diode forward voltage	V_{DF}	—	1.0	—	V	$I_F = 10 \text{ A}, V_{GS} = 0$
Body to drain diode reverse recovery time	t_{rr}	—	120	—	ns	$I_F = 10 \text{ A}, V_{GS} = 0,$ $di_F/dt = 100 \text{ A}/\mu\text{s}$

Note: 1. Pulse test

2SK1515, 2SK1516

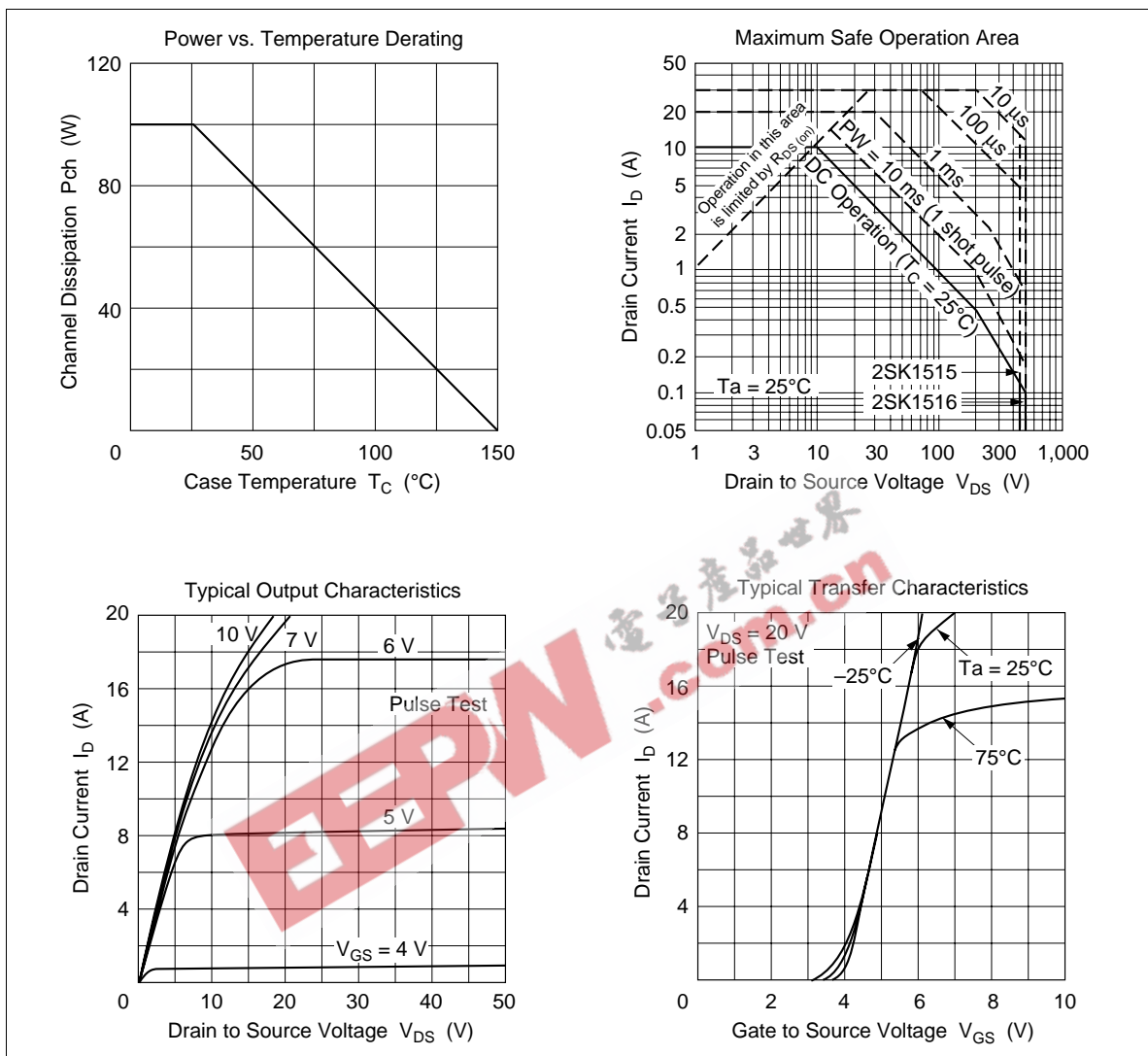

HITACHI

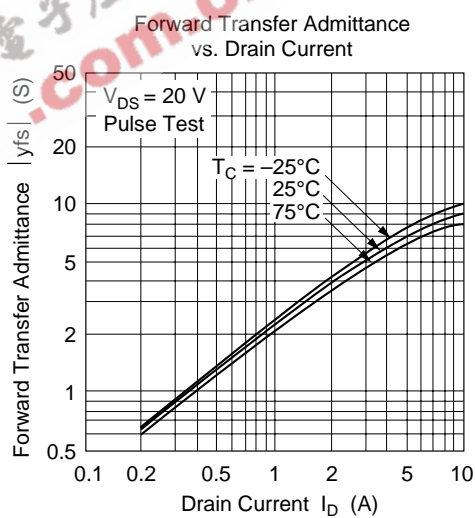
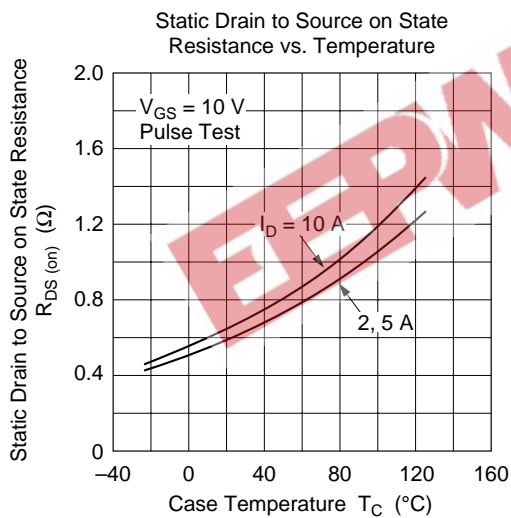
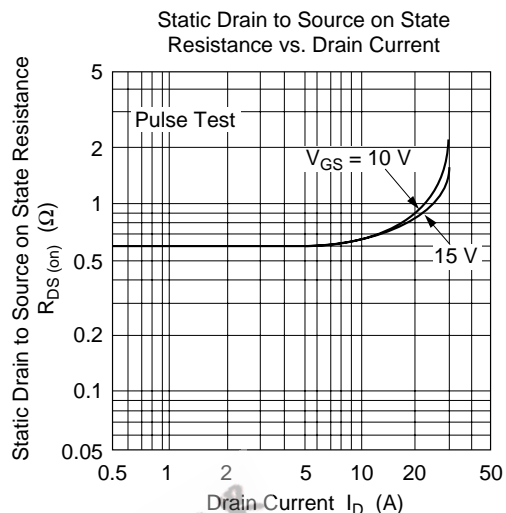
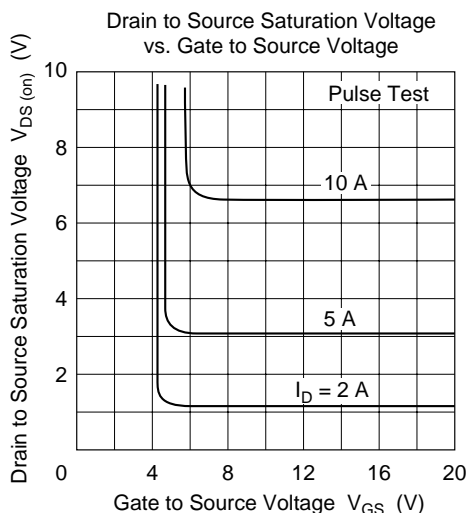

2SK1515, 2SK1516

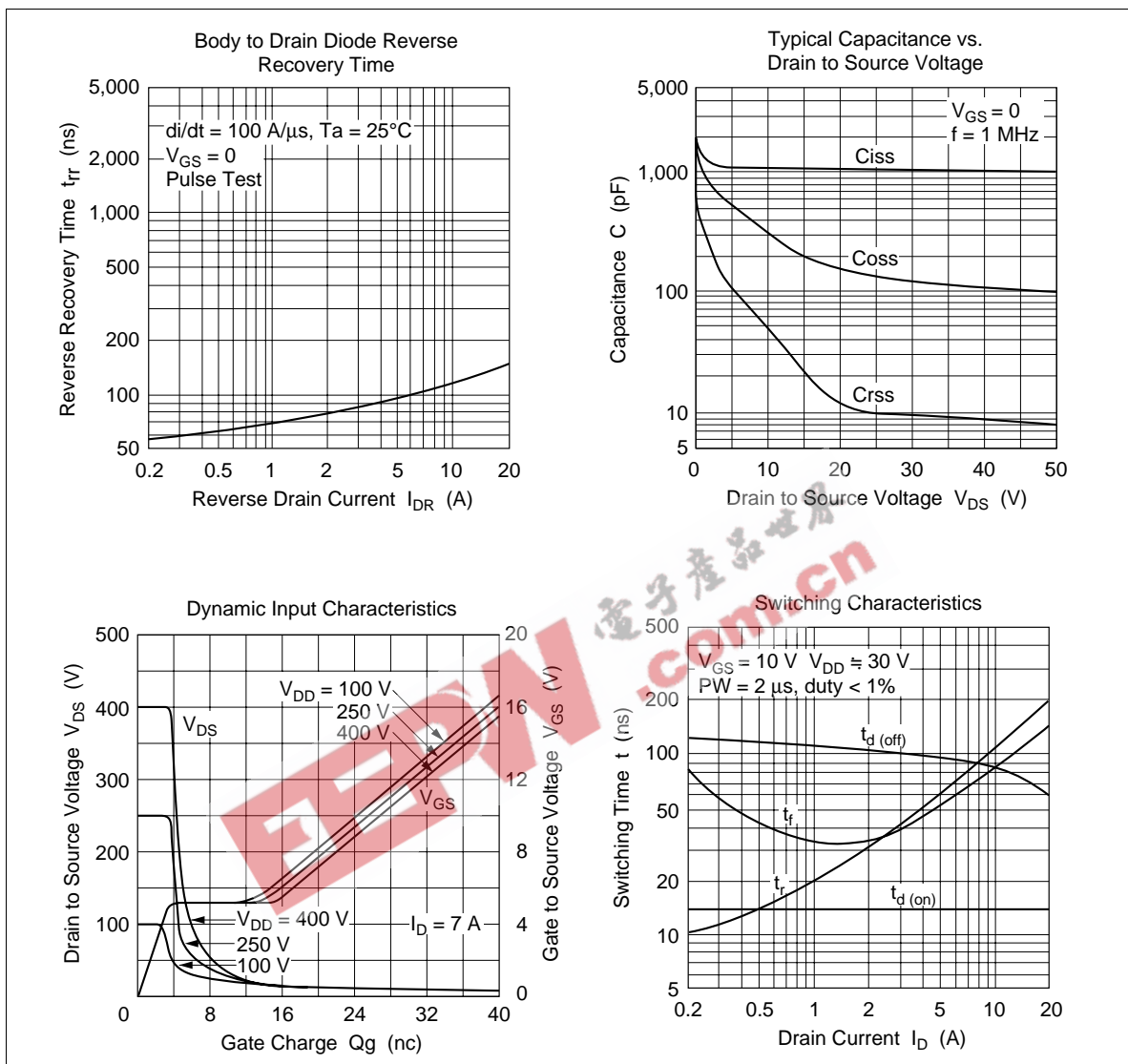

HITACHI

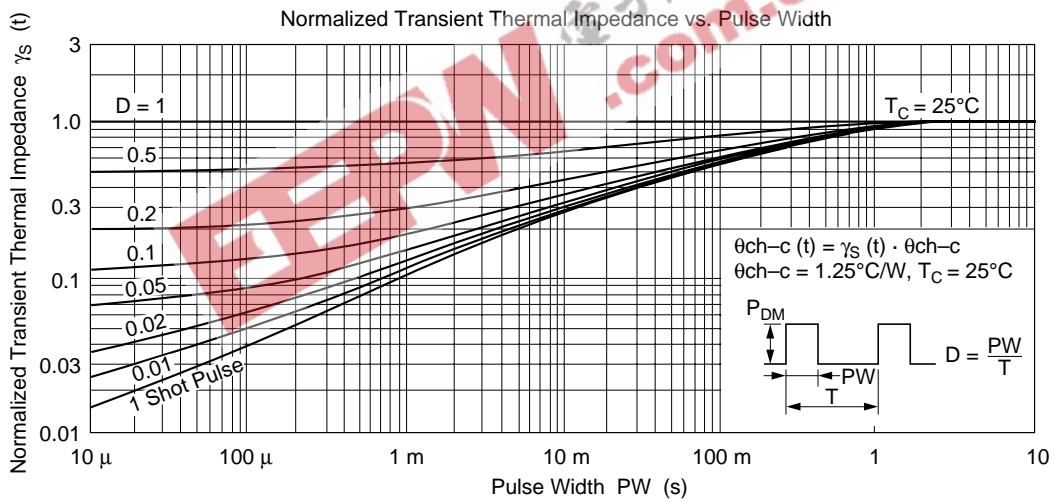
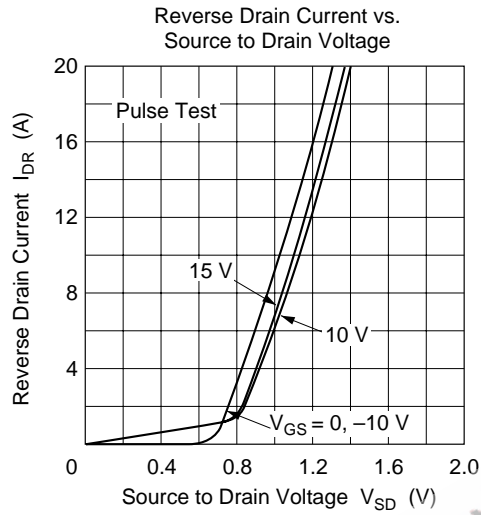

Switching Time Test Circuit

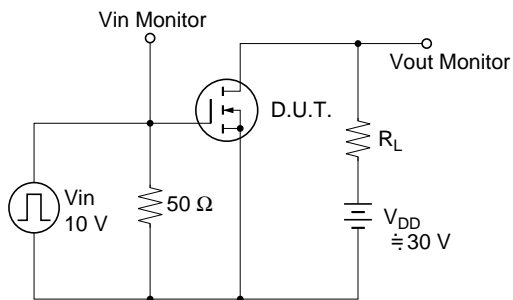

Waveforms

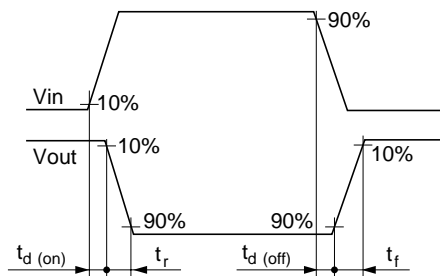

Unit: mm

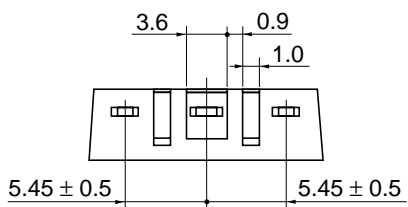
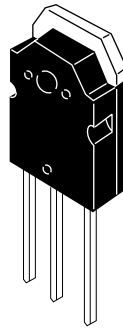
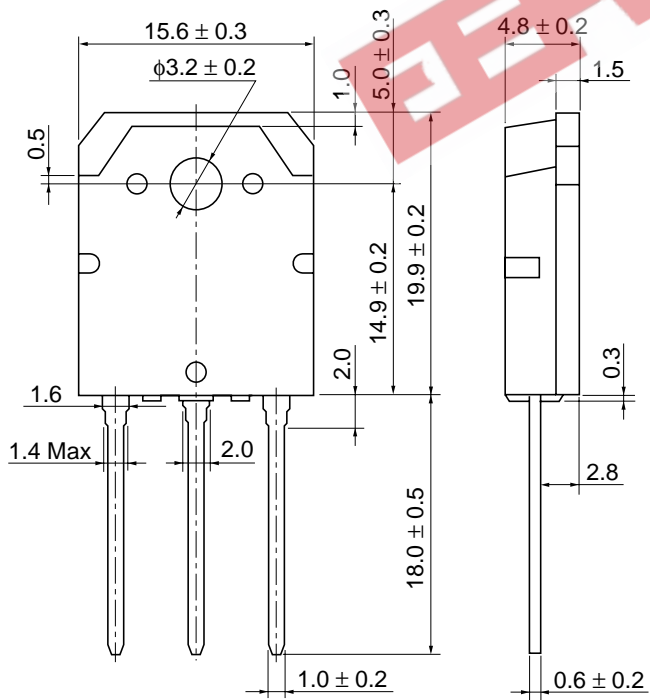

Hitachi Code	TO-3P
JEDEC	—
EIAJ	Conforms
Weight (reference value)	5.0 g

Cautions

1. Hitachi neither warrants nor grants licenses of any rights of Hitachi's or any third party's patent, copyright, trademark, or other intellectual property rights for information contained in this document. Hitachi bears no responsibility for problems that may arise with third party's rights, including intellectual property rights, in connection with use of the information contained in this document.
2. Products and product specifications may be subject to change without notice. Confirm that you have received the latest product standards or specifications before final design, purchase or use.
3. Hitachi makes every attempt to ensure that its products are of high quality and reliability. However, contact Hitachi's sales office before using the product in an application that demands especially high quality and reliability or where its failure or malfunction may directly threaten human life or cause risk of bodily injury, such as aerospace, aeronautics, nuclear power, combustion control, transportation, traffic, safety equipment or medical equipment for life support.
4. Design your application so that the product is used within the ranges guaranteed by Hitachi particularly for maximum rating, operating supply voltage range, heat radiation characteristics, installation conditions and other characteristics. Hitachi bears no responsibility for failure or damage when used beyond the guaranteed ranges. Even within the guaranteed ranges, consider normally foreseeable failure rates or failure modes in semiconductor devices and employ systemic measures such as fail-safes, so that the equipment incorporating Hitachi product does not cause bodily injury, fire or other consequential damage due to operation of the Hitachi product.
5. This product is not designed to be radiation resistant.
6. No one is permitted to reproduce or duplicate, in any form, the whole or part of this document without written approval from Hitachi.
7. Contact Hitachi's sales office for any questions regarding this document or Hitachi semiconductor products.

HITACHI

Hitachi, Ltd.

Semiconductor & Integrated Circuits.
Nippon Bldg., 2-6-2, Ohte-machi, Chiyoda-ku, Tokyo 100-0004, Japan
Tel: Tokyo (03) 3270-2111 Fax: (03) 3270-5109

URL North America : <http://semiconductor.hitachi.com/>
 Europe : <http://www.hitachi-eu.com/hel/ecg>
 Asia (Singapore) : <http://www.has.hitachi.com.sg/grp3/sicd/index.htm>
 Asia (Taiwan) : http://www.hitachi.com.tw/E/Product/SICD_Frame.htm
 Asia (HongKong) : <http://www.hitachi.com.hk/eng/bo/grp3/index.htm>
 Japan : <http://www.hitachi.co.jp/Sicd/indx.htm>

For further information write to:

Hitachi Semiconductor
(America) Inc.
179 East Tasman Drive,
San Jose, CA 95134
Tel: <1> (408) 433-1990
Fax: <1> (408) 433-0223

Hitachi Europe GmbH
Electronic components Group
Dornacher StraÙe 3
D-85622 Feldkirchen, Munich
Germany
Tel: <49> (89) 9 9180-0
Fax: <49> (89) 9 29 30 00

Hitachi Europe Ltd.
Electronic Components Group.
Whitebrook Park
Lower Cookham Road
Maidenhead
Berkshire SL6 8YA, United Kingdom
Tel: <44> (1628) 585000
Fax: <44> (1628) 778322

Hitachi Asia Pte. Ltd.
16 Collyer Quay #20-00
Hitachi Tower
Singapore 049318
Tel: 535-2100
Fax: 535-1533

Hitachi Asia Ltd.
Taipei Branch Office
3F, Hung Kuo Building, No.167,
Tun-Hwa North Road, Taipei (105)
Tel: <886> (2) 2718-3666
Fax: <886> (2) 2718-8180

Hitachi Asia (Hong Kong) Ltd.
Group III (Electronic Components)
7/F., North Tower, World Finance Centre,
Harbour City, Canton Road, Tsim Sha Tsui,
Kowloon, Hong Kong
Tel: <852> (2) 735 9218
Fax: <852> (2) 730 0281
Telex: 40815 HITEC HX

Copyright ' Hitachi, Ltd., 1999. All rights reserved. Printed in Japan.

HITACHI