

> **Features**

- High Current
- Low On-Resistance
- No Secondary Breakdown
- Low Driving Power
- Avalanche Rated

> **Applications**

- Motor Control
- General Purpose Power Amplifier
- DC-DC converters

> **Outline Drawing**

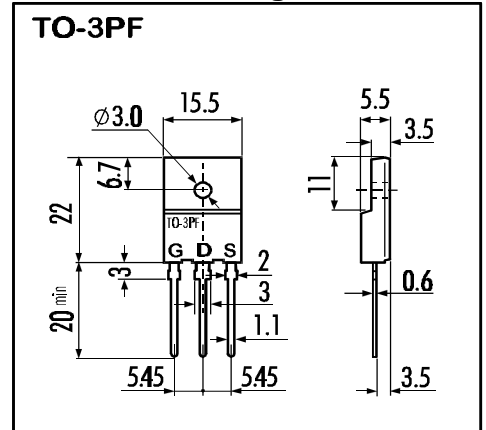

> **Maximum Ratings and Characteristics**

- Absolute Maximum Ratings ($T_C=25^\circ\text{C}$), unless otherwise specified

Item	Symbol	Rating	Unit
Drain-Source-Voltage	V_{DS}	60	V
Continous Drain Current	I_D	70	A
Pulsed Drain Current	$I_{D(puls)}$	280	A
Gate-Source-Voltage	V_{GS}	± 20	V
Maximum Avalanche Energy	E_{AV}	685	mJ*
Max. Power Dissipation	P_D	100	W
Operating and Storage Temperature Range	T_{ch}	150	$^\circ\text{C}$
	T_{stg}	-55 ~ +150	$^\circ\text{C}$

* $L=0,186\text{mH}$, $V_{CC}=24\text{V}$

> **Equivalent Circuit**

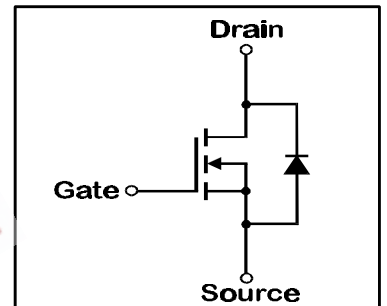

- Electrical Characteristics ($T_C=25^\circ\text{C}$), unless otherwise specified

Item	Symbol	Test conditions	Min.	Typ.	Max.	Unit
Drain-Source Breakdown-Voltage	$V_{(BR)DSS}$	$I_D=1\text{mA}$ $V_{GS}=0\text{V}$	60			V
Gate Threshold Voltage	$V_{GS(th)}$	$I_D=1\text{mA}$ $V_{DS}=V_{GS}$	1,0	1,5	2,0	V
Zero Gate Voltage Drain Current	I_{DSS}	$V_{DS}=60\text{V}$ $T_{ch}=25^\circ\text{C}$		10	500	μA
		$V_{GS}=0\text{V}$ $T_{ch}=125^\circ\text{C}$		0,2	1,0	mA
Gate Source Leakage Current	I_{GSS}	$V_{GS}=\pm 20\text{V}$ $V_{DS}=0\text{V}$		10	100	nA
Drain Source On-State Resistance	$R_{DS(on)}$	$I_D=40\text{A}$ $V_{GS}=4\text{V}$		0,012	0,017	Ω
		$I_D=40\text{A}$ $V_{GS}=10\text{V}$		0,0075	0,01	Ω
Forward Transconductance	g_{fs}	$I_D=40\text{A}$ $V_{DS}=25\text{V}$	25	55		S
Input Capacitance	C_{iss}	$V_{DS}=25\text{V}$		3500	5250	pF
Output Capacitance	C_{oss}	$V_{GS}=0\text{V}$		1250	1870	pF
Reverse Transfer Capacitance	C_{rss}	$f=1\text{MHz}$		360	540	pF
Turn-On-Time t_{on} ($t_{on}=t_{d(on)}+t_r$)	$t_{d(on)}$	$V_{CC}=30\text{V}$		15	23	ns
	t_r	$I_D=75\text{A}$		75	120	ns
Turn-Off-Time t_{off} ($t_{off}=t_{d(off)}+t_f$)	$t_{d(off)}$	$V_{GS}=10\text{V}$		190	285	ns
	t_f	$R_{GS}=10\Omega$		110	165	ns
Avalanche Capability	I_{AV}	$L=100\mu\text{H}$ $T_{ch}=25^\circ\text{C}$	70			A
Diode Forward On-Voltage	V_{SD}	$I_F=160\text{A}$ $V_{GS}=0\text{V}$ $T_{ch}=25^\circ\text{C}$		1,15	1,65	V
Reverse Recovery Time	t_{rr}	$I_F=80\text{A}$ $V_{GS}=0\text{V}$		75	120	ns
Reverse Recovery Charge	Q_{rr}	$-di_F/dt=100\text{A}/\mu\text{s}$ $T_{ch}=25^\circ\text{C}$		0,17		μC

- Thermal Characteristics

Item	Symbol	Test conditions	Min.	Typ.	Max.	Unit
Thermal Resistance	$R_{th(ch-a)}$	channel to air			30	$^\circ\text{C}/\text{W}$
	$R_{th(ch-c)}$	channel to case			1,25	$^\circ\text{C}/\text{W}$

> Characteristics

Typical Output Characteristics

$I_D = f(V_{DS})$; 80μs pulse test; $T_{ch} = 25^\circ\text{C}$

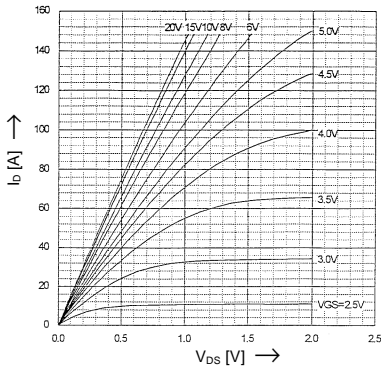

Drain-Source On-State Resistance vs. T_{ch}

$R_{DS(on)} = f(T_{ch})$; $I_D = 40\text{A}$; $V_{GS} = 10\text{V}$

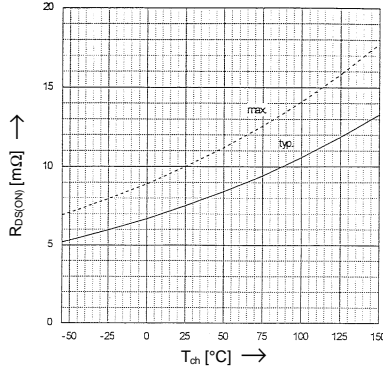

Typical Transfer Characteristics

$I_D = f(V_{GS})$; 80μs pulse test; $V_{DS} = 25\text{V}$; $T_{ch} = 25^\circ\text{C}$

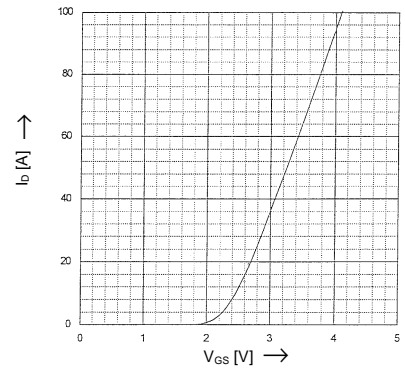

Typical Drain-Source On-State-Resistance vs. I_D

$R_{DS(on)} = f(I_D)$; 80μs pulse test; $T_{ch} = 25^\circ\text{C}$

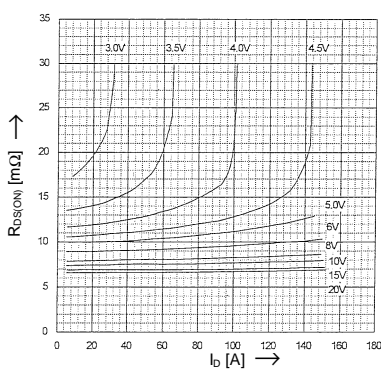

Typical Forward Transconductance vs. I_D

$g_{fs} = f(I_D)$; 80μs pulse test; $V_{DS} = 25\text{V}$; $T_{ch} = 25^\circ\text{C}$

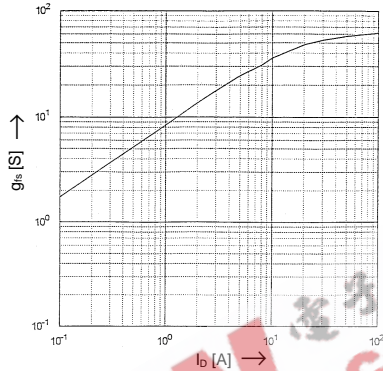

Gate Threshold Voltage vs. T_{ch}

$V_{GS(th)} = f(T_{ch})$; $I_D = 1\text{mA}$; $V_{DS} = V_{GS}$

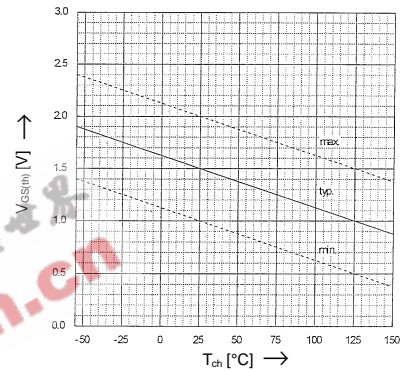

Typical Capacitances vs. V_{DS}

$C = f(V_{DS})$; $V_{GS} = 0\text{V}$; $f = 1\text{MHz}$

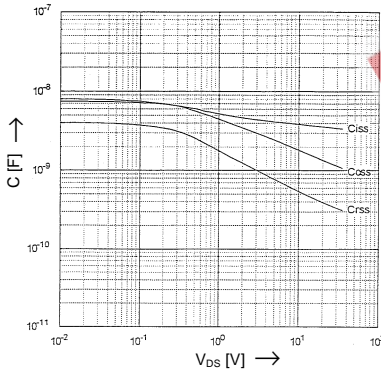

Typical Gate Charge Characteristic

$V_{GS} = f(Q_g)$; $I_D = 80\text{A}$; $T_{ch} = 25^\circ\text{C}$

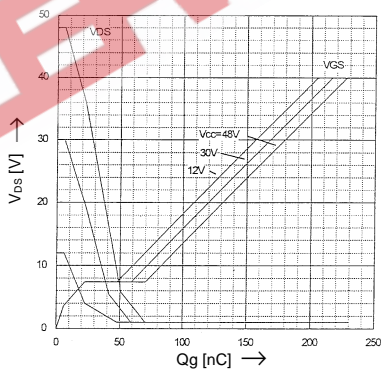

Forward Characteristics of Reverse Diode

$I_F = f(V_{SD})$; 80μs pulse test; $T_{ch} = 25^\circ\text{C}$

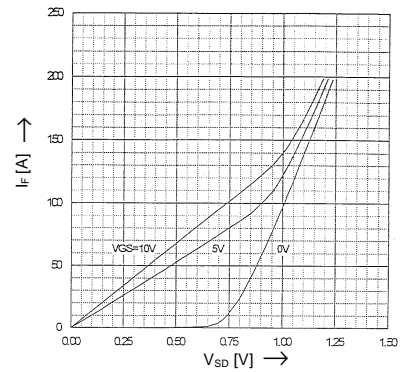

Maximum Avalanche Energy vs. starting T_{ch}

$E_{AV} = f(\text{starting } T_{ch})$; $V_{CC} = 24\text{V}$; $I_{AV} \leq 70\text{A}$

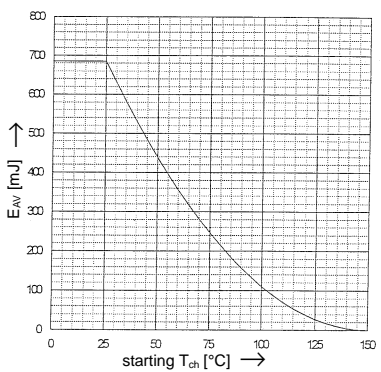

Safe Operation Area

$I_D = f(V_{DS})$; $D = 0,01$; $T_c = 25^\circ\text{C}$

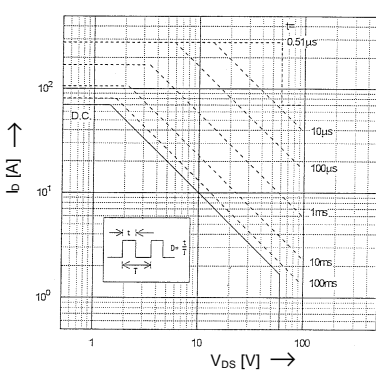

Transient Thermal impedance

$Z_{th(ch-e)} = f(t)$ parameter: $D = t/T$

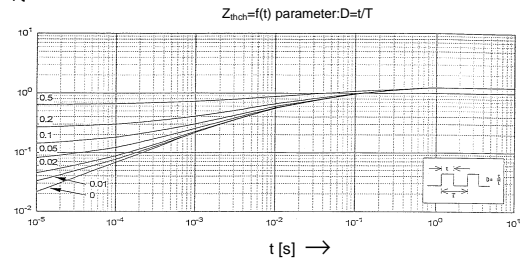

N-channel MOS-FET			
60V	0,01Ω	70A	100W

2SK2691-01R

FAP-IIIB Series



> Characteristics

