

# DATA SHEET

For a complete data sheet, please also download:

- The IC06 74HC/HCT/HCU/HCMOS Logic Family Specifications
- The IC06 74HC/HCT/HCU/HCMOS Logic Package Information
- The IC06 74HC/HCT/HCU/HCMOS Logic Package Outlines

EEPW 电子产品世界  
.com.cn

## 74HC/HCT541

Octal buffer/line driver; 3-state

Product specification  
File under Integrated Circuits, IC06

December 1990

## Octal buffer/line driver; 3-state

## 74HC/HCT541

## FEATURES

- Non-inverting outputs
- Output capability: bus driver
- $I_{CC}$  category: MSI

## GENERAL DESCRIPTION

The 74HC/HCT541 are high-speed Si-gate CMOS devices and are pin compatible with low power Schottky TTL (LSTTL). They are specified in compliance with JEDEC standard no. 7A.

The 74HC/HCT541 are octal non-inverting buffer/line drivers with 3-state outputs. The 3-state outputs are controlled by the output enable inputs  $\overline{OE}_1$  and  $\overline{OE}_2$ . A HIGH on  $\overline{OE}_n$  causes the outputs to assume a high impedance OFF-state.

The "541" is identical to the "540" but has non-inverting outputs.

## QUICK REFERENCE DATA

GND = 0 V;  $T_{amb} = 25\text{ }^\circ\text{C}$ ;  $t_r = t_f = 6\text{ ns}$

SYMBOL	PARAMETER	CONDITIONS	TYPICAL		UNIT
			HC	HCT	
$t_{PHL}/t_{PLH}$	propagation delay $A_n$ to $Y_n$	$C_L = 15\text{ pF}$ ; $V_{CC} = 5\text{ V}$	10	12	ns
$C_I$	input capacitance		3.5	3.5	pF
$C_{PD}$	power dissipation capacitance per buffer	notes 1 and 2	37	39	pF

## Notes

1.  $C_{PD}$  is used to determine the dynamic power dissipation ( $P_D$  in  $\mu\text{W}$ ):

$$P_D = C_{PD} \times V_{CC}^2 \times f_i + \sum (C_L \times V_{CC}^2 \times f_o) \text{ where:}$$

$f_i$  = input frequency in MHz

$f_o$  = output frequency in MHz

$\sum (C_L \times V_{CC}^2 \times f_o)$  = sum of outputs

$C_L$  = output load capacitance in pF

$V_{CC}$  = supply voltage in V

2. For HC the condition is  $V_I = \text{GND to } V_{CC}$   
For HCT the condition is  $V_I = \text{GND to } V_{CC} - 1.5\text{ V}$

## ORDERING INFORMATION

See "74HC/HCT/HCU/HCMOS Logic Package Information".

Octal buffer/line driver; 3-state

74HC/HCT541

PIN DESCRIPTION

PIN NO.	SYMBOL	NAME AND FUNCTION
1, 19	$\overline{OE}_1, \overline{OE}_2$	output enable input (active LOW)
2, 3, 4, 5, 6, 7, 8, 9	A <sub>0</sub> to A <sub>7</sub>	data inputs
10	GND	ground (0 V)
18, 17, 16, 15, 14, 13, 12, 11	Y <sub>0</sub> to Y <sub>7</sub>	bus outputs
20	V <sub>CC</sub>	positive supply voltage

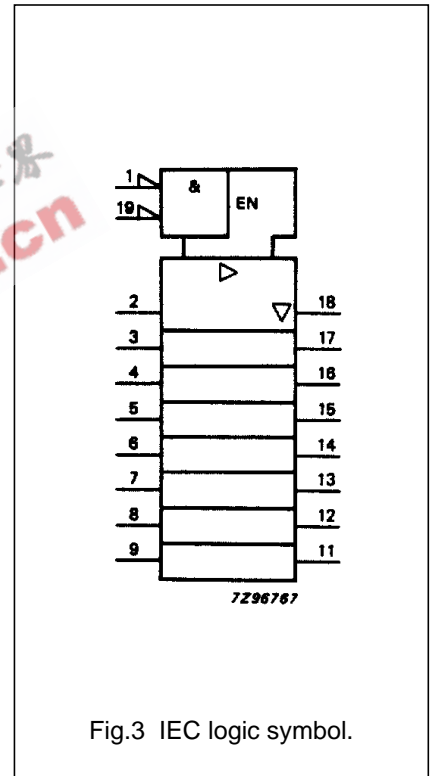
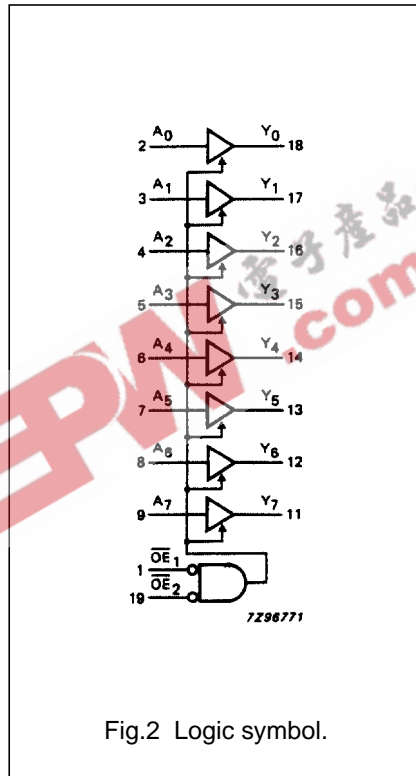
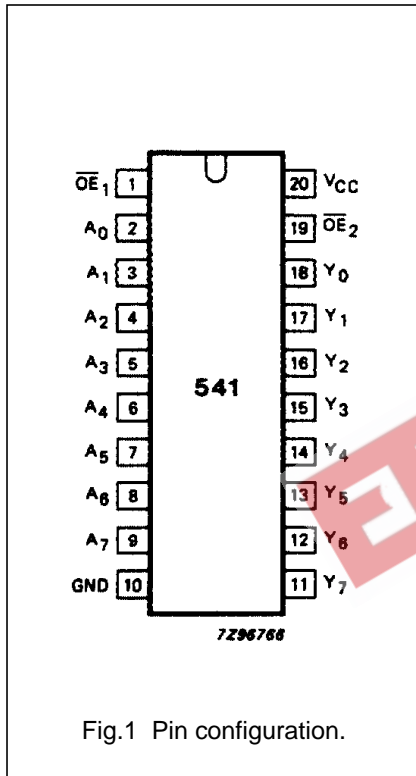

Octal buffer/line driver; 3-state

74HC/HCT541

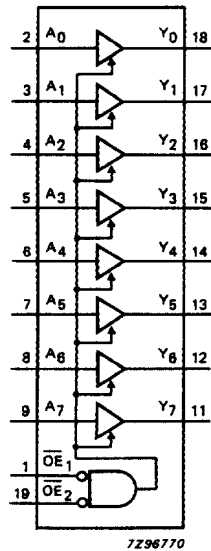

Fig.4 Functional diagram.

FUNCTION TABLE

INPUTS			OUTPUT
$\overline{OE}_1$	$\overline{OE}_2$	A <sub>n</sub>	Y <sub>n</sub>
L	L	L	L
L	L	H	H
X	H	X	Z
H	X	X	Z

Notes

- 1. H = HIGH voltage level
- L = LOW voltage level
- X = don't care
- Z = high impedance OFF-state

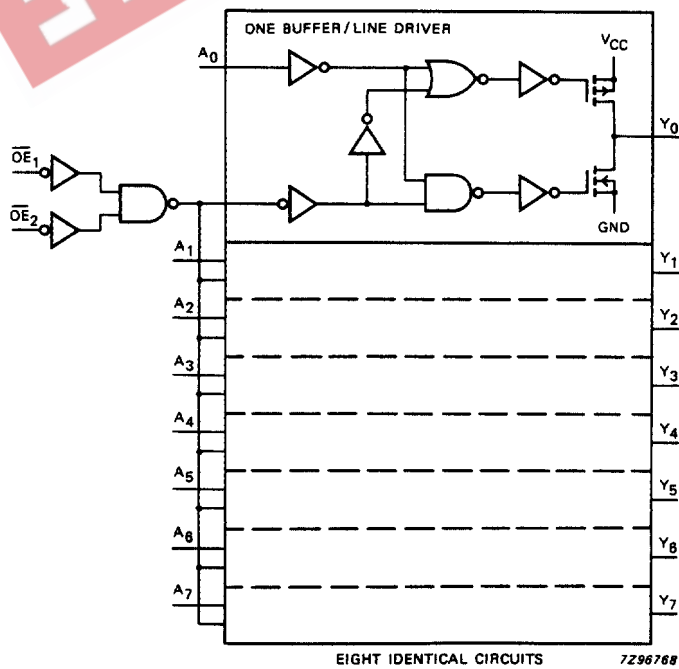

Fig.5 Logic diagram.

## Octal buffer/line driver; 3-state

## 74HC/HCT541

**DC CHARACTERISTICS FOR 74HC**

For the DC characteristics see *"74HC/HCT/HCU/HCMOS Logic Family Specifications"*.

Output capability: bus driver

I<sub>CC</sub> category: MSI

**AC CHARACTERISTICS FOR 74HC**

GND = 0 V; t<sub>r</sub> = t<sub>f</sub> = 6 ns; C<sub>L</sub> = 50 pF

SYMBOL	PARAMETER	T <sub>amb</sub> (°C)						UNIT	TEST CONDITIONS		
		74HC							V <sub>CC</sub> (V)	WAVEFORMS	
		+25			-40 to +85		-40 to +125				
		min.	typ.	max.	min.	max.	min.				max.
t <sub>PHL</sub> / t <sub>PLH</sub>	propagation delay A <sub>n</sub> to Y <sub>n</sub>		33 12 10	115 23 20		145 29 25	175 35 30	ns	2.0 4.5 6.0	Fig.6	
t <sub>PZH</sub> / t <sub>PZL</sub>	3-state output enable time $\overline{OE}$ to Y <sub>n</sub>		55 20 16	160 32 27		200 40 34	240 48 41	ns	2.0 4.5 6.0	Fig.7	
t <sub>PHZ</sub> / t <sub>PLZ</sub>	3-state output disable time $\overline{OE}$ to Y <sub>n</sub>		61 22 18	160 32 27		200 40 34	240 48 41	ns	2.0 4.5 6.0	Fig.7	
t <sub>THL</sub> / t <sub>TLH</sub>	output transition time		14 5 4	60 12 10		75 15 13	90 18 15	ns	2.0 4.5 6.0	Fig.6	

## Octal buffer/line driver; 3-state

## 74HC/HCT541

**DC CHARACTERISTICS FOR 74HCT**

For the DC characteristics see *"74HC/HCT/HCU/HCMOS Logic Family Specifications"*.

Output capability: bus driver

I<sub>CC</sub> category: MSI

**Note to HCT types**

The value of additional quiescent supply current ( $\Delta I_{CC}$ ) for a unit load of 1 is given in the family specifications. To determine  $\Delta I_{CC}$  per input, multiply this value by the unit load coefficient shown in the table below.

INPUT	UNIT LOAD COEFFICIENT
$\overline{OE}_1$	1.50
$\overline{OE}_2$	1.00
A <sub>n</sub>	0.70

**AC CHARACTERISTICS FOR 74HCT**

GND = 0 V; t<sub>r</sub> = t<sub>f</sub> = 6 ns; C<sub>L</sub> = 50 pF

SYMBOL	PARAMETER	T <sub>amb</sub> (°C)						UNIT	TEST CONDITIONS		
		74HCT							V <sub>CC</sub> (V)	WAVEFORMS	
		+25			-40 to +85		-40 to +125				
		min.	typ.	max.	min.	max.	min.				max.
t <sub>PHL</sub> / t <sub>PLH</sub>	propagation delay A <sub>n</sub> to Y <sub>n</sub>		15	28		35		42	ns	4.5	Fig.6
t <sub>PZH</sub> / t <sub>PZL</sub>	3-state output enable time $\overline{OE}$ to Y <sub>n</sub>		21	35		44		53	ns	4.5	Fig.7
t <sub>PHZ</sub> / t <sub>PLZ</sub>	3-state output disable time $\overline{OE}$ to Y <sub>n</sub>		21	35		44		53	ns	4.5	Fig.7
t <sub>THL</sub> / t <sub>TLH</sub>	output transition time		5	12		15		18	ns	4.5	Fig.6

Octal buffer/line driver; 3-state

74HC/HCT541

AC WAVEFORMS

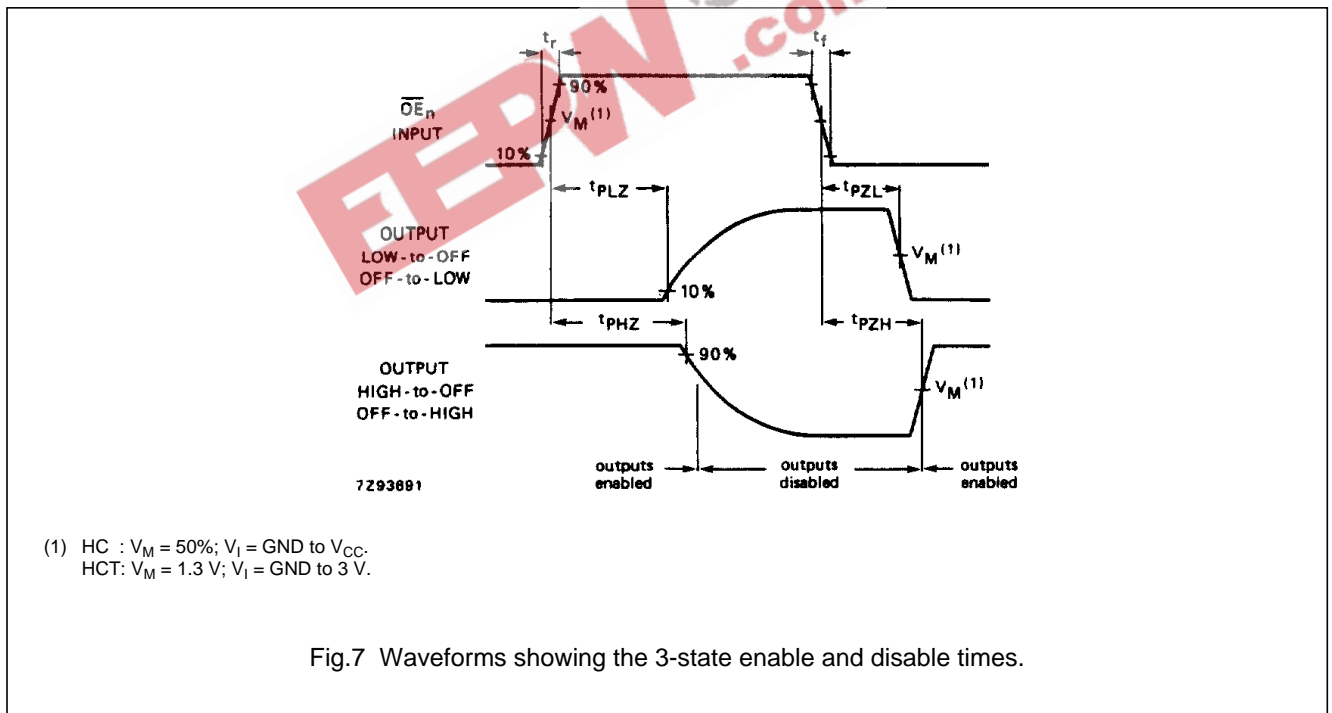
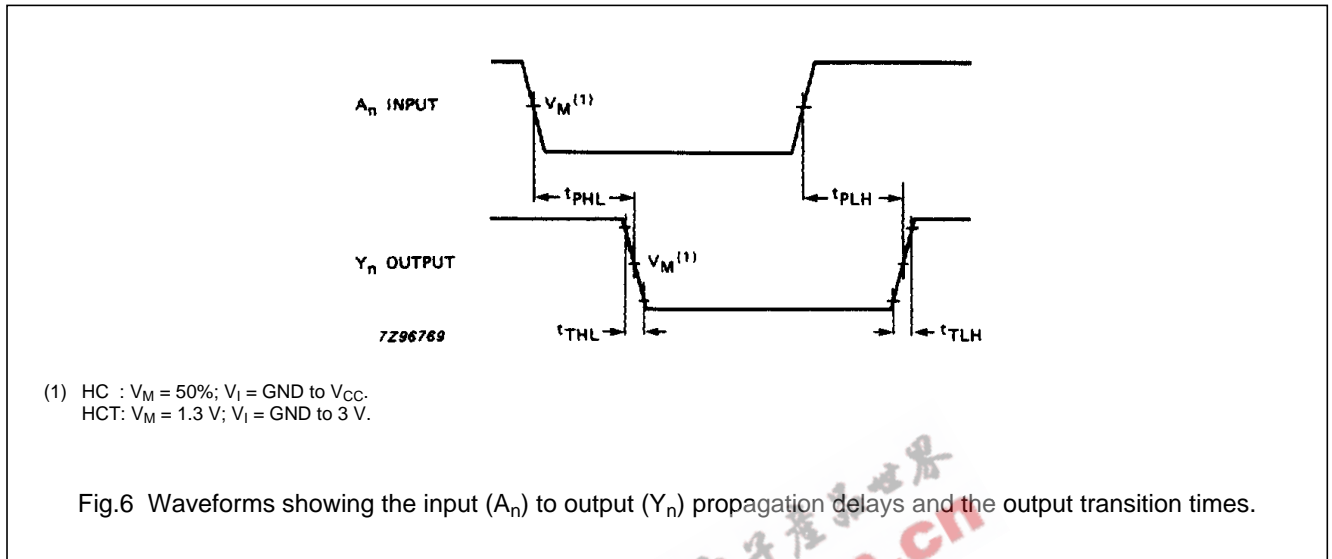

PACKAGE OUTLINES

See "74HC/HCT/HCU/HCMOS Logic Package Outlines".