

## 74ACTQ16646 16-Bit Transceiver/Register with 3-STATE Outputs

### General Description

The ACTQ16646 contains sixteen non-inverting bidirectional registered bus transceivers providing multiplexed transmission of data directly from the input bus or from the internal storage registers. Each byte has separate control inputs which can be shorted together for full 16-bit operation. The DIR inputs determine the direction of data flow through the device. The CPAB and CPBA inputs load data into the registers on the LOW-to-HIGH transition. The ACTQ16646 utilizes Fairchild Quiet Series™ technology to guarantee quiet output switching and improved dynamic threshold performance. FACT Quiet Series™ features GTO™ output control and undershoot corrector for superior performance.

### Features

- Utilizes Fairchild FACT Quiet Series technology
- Guaranteed simultaneous switching noise level and dynamic threshold performance
- Guaranteed pin-to-pin output skew
- Independent registers for A and B buses
- Multiplexed real-time and stored data transfers
- Separate control logic for each byte
- 16-bit version of the ACTQ646
- Outputs source/sink 24 mA
- Additional specs for Multiple Output Switching
- Output loading specs for both 50 pF and 250 pF loads

### Ordering Code:

| Order Number   | Package Number | Package Description   |
|----------------|----------------|---|
| 74ACTQ16646SSC | MS56A          | 56-Lead Shrink Small Outline Package (SSOP), JEDEC MO-118, 0.300" Wide      |
| 74ACTQ16646MTD | MTD56          | 56-Lead Thin Shrink Small Outline Package (TSSOP), JEDEC MO-153, 6.1mm Wide |

Device also available in Tape and Reel. Specify by appending suffix letter "X" to the ordering code.

### Logic Symbol

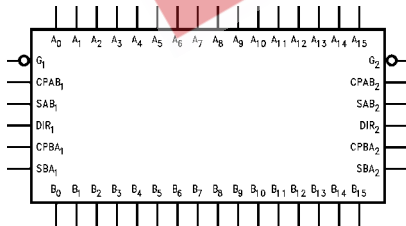

### Connection Diagram

Pin Assignment for  
SSOP and TSSOP

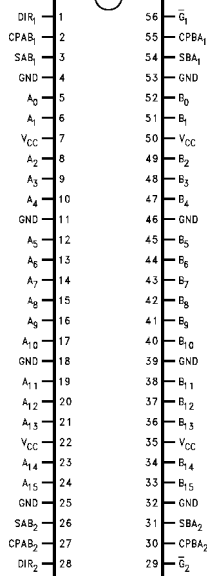

FACT™, Quiet Series™, FACT Quiet Series™ and GTO™ are trademarks of Fairchild Semiconductor Corporation.

**Function Table**

| Inputs         |                  |                   |                   |                  |                  | Data I/O (Note 1) |                  | Output Operation Mode                          |
|----------------|------------------|-------------------|-------------------|------------------|------------------|-------------------|------------------|--|
| G <sub>1</sub> | DIR <sub>1</sub> | CPAB <sub>1</sub> | CPBA <sub>1</sub> | SAB <sub>1</sub> | SBA <sub>1</sub> | A <sub>0-7</sub>  | B <sub>0-7</sub> |  |
| H              | X                | H or L            | H or L            | X                | X                | Input             | Input            | Isolation                                      |
| H              | X                | ↗                 | X                 | X                | X                |                   |                  | Clock An Data into A Register                  |
| H              | X                | X                 | ↗                 | X                | X                |                   |                  | Clock Bn Data Into B Register                  |
| L              | H                | X                 | X                 | L                | X                | Input             | Output           | An to Bn—Real Time (Transparent Mode)          |
| L              | H                | ↗                 | X                 | L                | X                |                   |                  | Clock An Data to A Register                    |
| L              | H                | H or L            | X                 | H                | X                |                   |                  | A Register to Bn (Stored Mode)                 |
| L              | H                | ↗                 | X                 | H                | X                |                   |                  | Clock An Data into A Register and Output to Bn |
| L              | L                | X                 | X                 | X                | L                | Output            | Input            | Bn to An—Real Time (Transparent Mode)          |
| L              | L                | X                 | ↗                 | X                | L                |                   |                  | Clock Bn Data into B Register                  |
| L              | L                | X                 | H or L            | X                | H                |                   |                  | B Register to An (Stored Mode)                 |
| L              | L                | X                 | ↗                 | X                | H                |                   |                  | Clock Bn into B Register and Output to An      |

H = HIGH Voltage Level    X = Immaterial  
 L = LOW Voltage Level    ↗ = LOW-to-HIGH Transition.

**Note 1:** The data output functions may be enabled or disabled by various signals at the G and DIR inputs. Data input functions are always enabled; i.e., data at the bus pins will be stored on every LOW-to-HIGH transition of the appropriate clock inputs. Also applies to data I/O (A and B: 8-15) and #2 control pins.

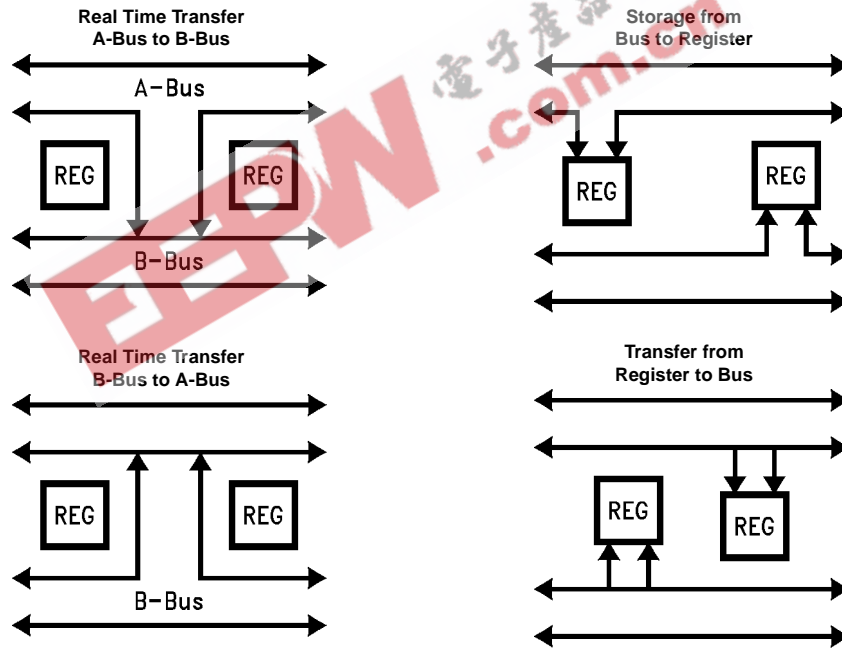

# Logic Diagram

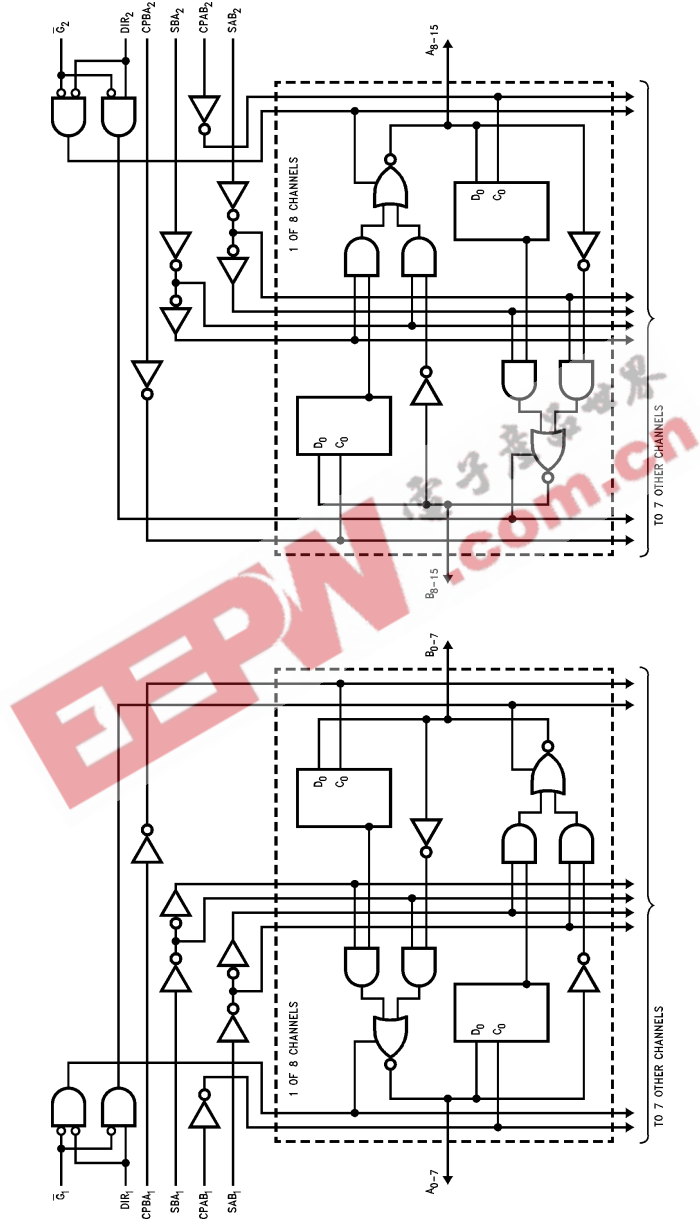

74ACTQ16646

| Absolute Maximum Ratings (Note 2)            |                          | Recommended Operating Conditions  |                |
|--|--------------------------|---|----------------|
| Supply Voltage ( $V_{CC}$ )                  | -0.5V to +7.0V           | Supply Voltage ( $V_{CC}$ )   | 4.5V to 5.5V   |
| DC Input Diode Current ( $I_{IK}$ )          |                          | Input Voltage ( $V_I$ )   | 0V to $V_{CC}$ |
| $V_I = -0.5V$                                | -20 mA                   | Output Voltage ( $V_O$ )  | 0V to $V_{CC}$ |
| $V_I = V_{CC} + 0.5V$                        | +20 mA                   | Operating Temperature ( $T_A$ )   | -40°C to +85°C |
| DC Output Diode Current ( $I_{OK}$ )         |                          | Minimum Input Edge Rate ( $\Delta V/\Delta t$ )   | 125 mV/ns      |
| $V_O = -0.5V$                                | -20 mA                   | $V_{IN}$ from 0.8V to 2.0V  |                |
| $V_O = V_{CC} + 0.5V$                        | +20 mA                   | $V_{CC}$ @ 4.5V, 5.5V   |                |
| DC Output Voltage ( $V_O$ )                  | -0.5V to $V_{CC} + 0.5V$ | <b>Note 2:</b> Absolute maximum ratings are those values beyond which damage to the device may occur. The databook specifications should be met, without exception to ensure that the system design is reliable over its power supply, temperature, and output/input loading variables. Fairchild does not recommend operation of FACT™ circuits outside databook specifications. |                |
| DC Output Source/Sink Current ( $I_O$ )      | ±50 mA                   |   |                |
| DC $V_{CC}$ or Ground Current per Output Pin | ±50 mA                   |   |                |
| Storage Temperature                          | -65°C to +150°C          |   |                |

### DC Electrical Characteristics

| Symbol    | Parameter                                | $V_{CC}$<br>(V) | $T_A = +25^\circ\text{C}$ |                   | $T_A = -40^\circ\text{C to } +85^\circ\text{C}$ |    | Units  | Conditions |
|-----------|--|-----------------|---------------------------|-------------------|---|----|--|------------|
|           |  |                 | Typ                       | Guaranteed Limits |   |    |  |            |
| $V_{IH}$  | Minimum HIGH Input Voltage               | 4.5             | 1.5                       | 2.0               | 2.0   | V  | $V_{OUT} = 0.1V$<br>or $V_{CC} - 0.1V$   |            |
|           |  | 5.5             | 1.5                       | 2.0               | 2.0   |    |  |            |
| $V_{IL}$  | Maximum LOW Input Voltage                | 4.5             | 1.5                       | 0.8               | 0.8   | V  | $V_{OUT} = 0.1V$<br>or $V_{CC} - 0.1V$   |            |
|           |  | 5.5             | 1.5                       | 0.8               | 0.8   |    |  |            |
| $V_{OH}$  | Minimum HIGH Output Voltage              | 4.5             | 4.49                      | 4.4               | 4.4   | V  | $I_{OUT} = -50 \mu\text{A}$  |            |
|           |  | 5.5             | 5.49                      | 5.4               | 5.4   |    |  |            |
|           |  | 4.5             |                           | 3.86              | 3.76  | V  | $V_{IN} = V_{IL}$ or $V_{IH}$<br>$I_{OH} = -24 \text{ mA}$<br>$I_{OH} = -24 \text{ mA}$ (Note 3) |            |
|           |  | 5.5             |                           | 4.86              | 4.76  |    |  |            |
| $V_{OL}$  | Maximum LOW Output Voltage               | 4.5             | 0.001                     | 0.1               | 0.1   | V  | $I_{OUT} = 50 \mu\text{A}$   |            |
|           |  | 5.5             | 0.001                     | 0.1               | 0.1   |    |  |            |
|           |  | 4.5             |                           | 0.36              | 0.44  | V  | $V_{IN} = V_{IL}$ or $V_{IH}$<br>$I_{OL} = 24 \text{ mA}$<br>$I_{OL} = 24 \text{ mA}$ (Note 3)   |            |
|           |  | 5.5             |                           | 0.36              | 0.44  |    |  |            |
| $I_{OZT}$ | Maximum I/O Leakage Current              | 5.5             |                           | ±0.5              | ±5.0  | μA | $V_{IN} = V_{IL}$ , $V_{IH}$<br>$V_O = V_{CC}$ , GND   |            |
| $I_{IN}$  | Maximum Input Leakage Current            | 5.5             |                           | ±0.1              | ±1.0  | μA | $V_I = V_{CC}$ , GND   |            |
| $I_{CCT}$ | Maximum $I_{CC}$ /Input                  | 5.5             | 0.6                       |                   | 1.5   | mA | $V_I = V_{CC} - 2.1V$  |            |
| $I_{CC}$  | Max Quiescent Supply Current             | 5.5             |                           | 8.0               | 80.0  | μA | $V_{IN} = V_{CC}$ or GND   |            |
| $I_{OLD}$ | Minimum Dynamic Output Current (Note 4)  | 5.5             |                           |                   | 75  | mA | $V_{OLD} = 1.65V$ Max  |            |
| $I_{OHD}$ | Output Current (Note 4)                  | 5.5             |                           |                   | -75   | mA | $V_{OHD} = 3.85V$ Min  |            |
| $V_{OLP}$ | Quick Output Maximum Dynamic $V_{OL}$    | 5.0             | 0.5                       | 0.8               |   | V  | Figure 1, Figure 2 (Note 6)(Note 7)  |            |
| $V_{OLV}$ | Quick Output Minimum Dynamic $V_{OL}$    | 5.0             | -0.5                      | -0.8              |   | V  | Figure 1, Figure 2 (Note 6)(Note 7)  |            |
| $V_{OHP}$ | Maximum Overshoot                        | 5.0             | $V_{OH} + 1.0$            | $V_{OH} + 1.5$    |   | V  | Figure 1, Figure 2 (Note 5)(Note 7)  |            |
| $V_{OHV}$ | Minimum $V_{CC}$ Droop                   | 5.0             | $V_{OH} - 1.0$            | $V_{OH} - 1.8$    |   | V  | Figure 1, Figure 2 (Note 5)(Note 7)  |            |
| $V_{IHD}$ | Minimum HIGH Dynamic Input Voltage Level | 5.0             | 1.7                       | 2.0               |   | V  | (Note 5)(Note 8)   |            |
| $V_{ILD}$ | Maximum LOW Dynamic Input Voltage Level  | 5.0             | 1.2                       | 0.8               |   | V  | (Note 5)(Note 8)   |            |

**Note 3:** All outputs loaded; thresholds associated with output under test.

**Note 4:** Maximum test duration 2.0 ms; one output loaded at a time.

**Note 5:** Worst case package.

**DC Electrical Characteristics** (Continued)

**Note 6:** Maximum number of outputs that can switch simultaneously is n. (n – 1) outputs are switched LOW and one output held LOW.

**Note 7:** Maximum number of outputs that can switch simultaneously is n. (n – 1) outputs are switched HIGH and one output held HIGH.

**Note 8:** Maximum number of data inputs (n) switching. (n – 1) inputs switching 0V to 3V (ACTQ). Input under test switching 3V to threshold ( $V_{ILD}$ ).

**AC Electrical Characteristics**

| Symbol           | Parameter                                 | V <sub>CC</sub><br>(V)<br>(Note 9) | T <sub>A</sub> = +25°C<br>C <sub>L</sub> = 50 pF |     |      | T <sub>A</sub> = -40°C to +85°C<br>C <sub>L</sub> = 50 pF |      | Units |
|------------------|---|------------------------------------|--|-----|------|---|------|-------|
|                  |   |                                    | Min  | Typ | Max  | Min   | Max  |       |
| t <sub>PHL</sub> | Propagation Delay                         | 5.0                                | 4.6  | 6.9 | 9.4  | 3.6   | 10.1 | ns    |
| t <sub>PLH</sub> | Clock to Bus                              |                                    | 4.3  | 6.5 | 8.9  | 3.3   | 9.7  |       |
| t <sub>PHL</sub> | Propagation Delay                         | 5.0                                | 4.0  | 6.2 | 8.5  | 2.9   | 9.2  | ns    |
| t <sub>PLH</sub> | Bus to Bus                                |                                    | 4.1  | 6.4 | 8.6  | 3.2   | 9.3  |       |
| t <sub>PHL</sub> | Propagation Delay                         | 5.0                                | 4.0  | 6.4 | 8.9  | 3.1   | 9.6  | ns    |
| t <sub>PLH</sub> | Select to Bus<br>(w/An or Bn HIGH or LOW) |                                    | 4.2  | 6.7 | 9.5  | 3.2   | 10.4 |       |
| t <sub>PZL</sub> | Enable Time                               | 5.0                                | 5.3  | 7.8 | 10.5 | 3.8   | 11.4 | ns    |
| t <sub>PZH</sub> | G to An/Bn                                |                                    | 4.6  | 6.9 | 9.4  | 3.3   | 10.2 |       |
| t <sub>PLZ</sub> | Disable Time                              | 5.0                                | 3.0  | 5.5 | 8.1  | 2.3   | 8.6  | ns    |
| t <sub>PHZ</sub> | G to An/Bn                                |                                    | 3.4  | 5.7 | 8.3  | 2.6   | 8.6  |       |
| t <sub>PZL</sub> | Enable Time                               | 5.0                                | 5.1  | 8.2 | 11.8 | 4.3   | 12.7 | ns    |
| t <sub>PZH</sub> | DIR to An/Bn                              |                                    | 4.6  | 7.5 | 10.8 | 3.7   | 11.7 |       |
| t <sub>PLZ</sub> | Disable Time                              | 5.0                                | 2.9  | 5.8 | 9.2  | 2.0   | 9.8  | ns    |
| t <sub>PHZ</sub> | DIR to An/Bn                              |                                    | 3.4  | 6.1 | 9.2  | 2.5   | 9.7  |       |

**Note 9:** Voltage Range 5.0 is 5.0V ± 0.5V.

**AC Operating Requirements**

| Symbol             | Parameter                          | V <sub>CC</sub><br>(V)<br>(Note 10) | T <sub>A</sub> = +25°C | T <sub>A</sub> = -40°C to +85°C | Units |
|--------------------|------------------------------------|-------------------------------------|------------------------|---------------------------------|-------|
|                    |                                    |                                     | C <sub>L</sub> = 50 pF | C <sub>L</sub> = 50 pF          |       |
| Guaranteed Minimum |                                    |                                     |                        |                                 |       |
| t <sub>S</sub>     | Setup Time, H or L<br>Bus to Clock | 5.0                                 | 3.0                    | 3.0                             | ns    |
| t <sub>H</sub>     | Hold Time, H or L<br>Bus to Clock  | 5.0                                 | 1.5                    | 1.5                             | ns    |
| t <sub>W</sub>     | Clock Pulse Width<br>H or L        | 5.0                                 | 4.0                    | 4.0                             | ns    |

**Note 10:** Voltage Range 5.0 is 5.0V ± 0.5V.

| Extended AC Electrical Characteristics |  |   |     |      |  |      |       |
|--|--|---|-----|------|--|------|-------|
| Symbol                                 | Parameter  | T <sub>A</sub> = -40°C to +85°C<br>V <sub>CC</sub> = Com<br>C <sub>L</sub> = 50 pF<br>16 Outputs Switching<br>(Note 12) |     |      | T <sub>A</sub> = -40°C to +85°C<br>V <sub>CC</sub> = Com<br>C <sub>L</sub> = 250 pF<br>(Note 13) |      | Units |
|  |  | Min   | Typ | Max  | Min  | Max  |       |
| t <sub>PHL</sub>                       | Propagation Delay  | 4.1   |     | 10.1 | 6.1  | 14.5 | ns    |
| t <sub>PLH</sub>                       | Clock to Bus   | 4.2   |     | 10.1 | 6.0  | 14.8 |       |
| t <sub>PHL</sub>                       | Propagation Delay  | 4.0   |     | 10.0 | 5.4  | 13.7 | ns    |
| t <sub>PLH</sub>                       | Bus to Bus   | 4.7   |     | 10.7 | 5.9  | 13.5 |       |
| t <sub>PHL</sub>                       | Propagation Delay  | 3.8   |     | 9.6  | 5.7  | 14.2 | ns    |
| t <sub>PLH</sub>                       | Select to Bus<br>(w/An or Bn HIGH or LOW)                    | 4.3   |     | 10.9 | 6.1  | 15.5 |       |
| t <sub>PZL</sub>                       | Enable Time  | 5.0   |     | 12.7 | (Note 14)  |      | ns    |
| t <sub>PZH</sub>                       | G to An/Bn   | 4.1   |     | 11.3 |  |      |       |
| t <sub>PLZ</sub>                       | Disable Time   | 3.2   |     | 8.3  | (Note 15)  |      | ns    |
| t <sub>PHZ</sub>                       | G to An/Bn   | 3.5   |     | 8.6  |  |      |       |
| t <sub>PZL</sub>                       | Enable Time  | 4.1   |     | 11.3 | (Note 14)  |      | ns    |
| t <sub>PZH</sub>                       | DIR to An/Bn   | 4.4   |     | 13.0 |  |      |       |
| t <sub>PLZ</sub>                       | Disable Time   | 2.9   |     | 9.5  | (Note 15)  |      | ns    |
| t <sub>PHZ</sub>                       | DIR to An/Bn   | 3.4   |     | 9.7  |  |      |       |
| t <sub>OSSL</sub><br>(Note 11)         | Pin-to-Pin Skew<br>Clock to Bus                              |   |     | 1.0  |  |      | ns    |
| t <sub>OSLH</sub><br>(Note 11)         | Pin-to-Pin Skew<br>Clock to Bus                              |   |     | 1.0  |  |      | ns    |
| t <sub>OSSL</sub><br>(Note 11)         | Pin-to-Pin Skew<br>Bus to Bus                                |   |     | 1.0  |  |      | ns    |
| t <sub>OSLH</sub><br>(Note 11)         | Pin-to-Pin Skew<br>Bus to Bus                                |   |     | 1.0  |  |      | ns    |
| t <sub>OSSL</sub><br>(Note 11)         | Pin-to-Pin Skew<br>Select to Bus<br>(w/An or Bn HIGH or LOW) |   |     | 1.0  |  |      | ns    |
| t <sub>OSLH</sub><br>(Note 11)         | Pin-to-Pin Skew<br>Select to Bus<br>(w/An or Bn HIGH or LOW) |   |     | 1.2  |  |      | ns    |
| t <sub>OST</sub><br>(Note 11)          | Pin-to-Pin Skew<br>Clock to Bus                              |   |     | 2.1  |  |      | ns    |
| t <sub>OST</sub><br>(Note 11)          | Pin-to-Pin Skew<br>Bus to Bus                                |   |     | 1.0  |  |      | ns    |
| t <sub>OST</sub><br>(Note 11)          | Pin-to-Pin Skew<br>Select to Bus                             |   |     | 2.7  |  |      | ns    |

**Note 11:** Skew is defined as the absolute value of the difference between the actual propagation delays for any two separate outputs of the same device. The specification applies to any outputs switching HIGH to LOW (t<sub>OSSL</sub>), LOW to HIGH (t<sub>OSLH</sub>), or any combination switching LOW to HIGH and/or HIGH to LOW (t<sub>OST</sub>).

**Note 12:** This specification is guaranteed but not tested. The limits apply to propagation delays for all paths described switching in phase (i.e., all LOW-to-HIGH, HIGH-to-LOW, etc.).

**Note 13:** This specification is guaranteed but not tested. The limits represent propagation delays with 250 pF load capacitors in place of the 50 pF load capacitors in the standard AC load. This specification pertains to single output switching only.

**Note 14:** 3-STATE delays are load dominated and have been excluded from the datasheet.

**Note 15:** The Output Disable Time is dominated by the RC network (500Ω, 250 pF) on the output and has been excluded from the datasheet.

### Capacitance

| Symbol          | Parameter                     | Typ | Units | Conditions             |
|-----------------|-------------------------------|-----|-------|------------------------|
| C <sub>IN</sub> | Input Capacitance             | 4.5 | pF    | V <sub>CC</sub> = 5.0V |
| C <sub>PD</sub> | Power Dissipation Capacitance | 95  | pF    | V <sub>CC</sub> = 5.0V |

## FACT Noise Characteristics

The setup of a noise characteristics measurement is critical to the accuracy and repeatability of the tests. The following is a brief description of the setup used to measure the noise characteristics of FACT.

### Equipment:

Hewlett Packard Model 8180A Word Generator  
PC-163A Test Fixture  
Tektronics Model 7854 Oscilloscope

### Procedure:

1. Verify Test Fixture Loading: Standard Load 50 pF, 500Ω.
2. Deskw the HFS generator so that no two channels have greater than 150 ps skew between them. This requires that the oscilloscope be deskewed first. It is important to deskw the HFS generator channels before testing. This will ensure that the outputs switch simultaneously.
3. Terminate all inputs and outputs to ensure proper loading of the outputs and that the input levels are at the correct voltage.
4. Set the HFS generator to toggle all but one output at a frequency of 1 MHz. Greater frequencies will increase DUT heating and effect the results of the measurement.



$V_{OHV}$  and  $V_{OLP}$  are measured with respect to ground reference.

Input pulses have the following characteristics:  $f = 1$  MHz,  $t_r = 3$  ns,  $t_f = 3$  ns, skew < 150 ps.

**FIGURE 1. Quiet Output Noise Voltage Waveforms**

5. Set the word generator input levels at 0V LOW and 3V HIGH for ACT devices and 0V LOW and 5V HIGH for AC devices. Verify levels with an oscilloscope.

$V_{OLP}/V_{OLV}$  and  $V_{OHP}/V_{OHV}$ :

- Determine the quiet output pin that demonstrates the greatest noise levels. The worst case pin will usually be the furthest from the ground pin. Monitor the output voltages using a 50Ω coaxial cable plugged into a standard SMB type connector on the test fixture. Do not use an active FET probe.
- Measure  $V_{OLP}$  and  $V_{OLV}$  on the quiet output during the worst case transition for active and enable. Measure  $V_{OHP}$  and  $V_{OHV}$  on the quiet output during the worst case transition for active and enable.
- Verify that the GND reference recorded on the oscilloscope has not drifted to ensure the accuracy and repeatability of the measurements.

$V_{ILD}$  and  $V_{IHD}$ :

- Monitor one of the switching outputs using a 50Ω coaxial cable plugged into a standard SMB type connector on the test fixture. Do not use an active FET probe.
- First increase the input LOW voltage level,  $V_{IL}$ , until the output begins to oscillate or steps out a min of 2 ns. Oscillation is defined as noise on the output LOW level that exceeds  $V_{IL}$  limits, or on output HIGH levels that exceed  $V_{IH}$  limits. The input LOW voltage level at which oscillation occurs is defined as  $V_{ILD}$ .
- Next decrease the input HIGH voltage level,  $V_{IH}$ , until the output begins to oscillate or steps out a min of 2 ns. Oscillation is defined as noise on the output LOW level that exceeds  $V_{IL}$  limits, or on output HIGH levels that exceed  $V_{IH}$  limits. The input HIGH voltage level at which oscillation occurs is defined as  $V_{IHD}$ .
- Verify that the GND reference recorded on the oscilloscope has not drifted to ensure the accuracy and repeatability of the measurements.

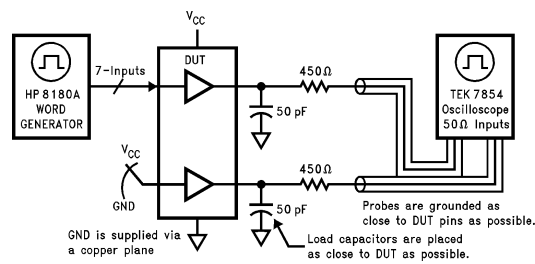

**FIGURE 2. Simultaneous Switching Test Circuit**

**Physical Dimensions** inches (millimeters) unless otherwise noted

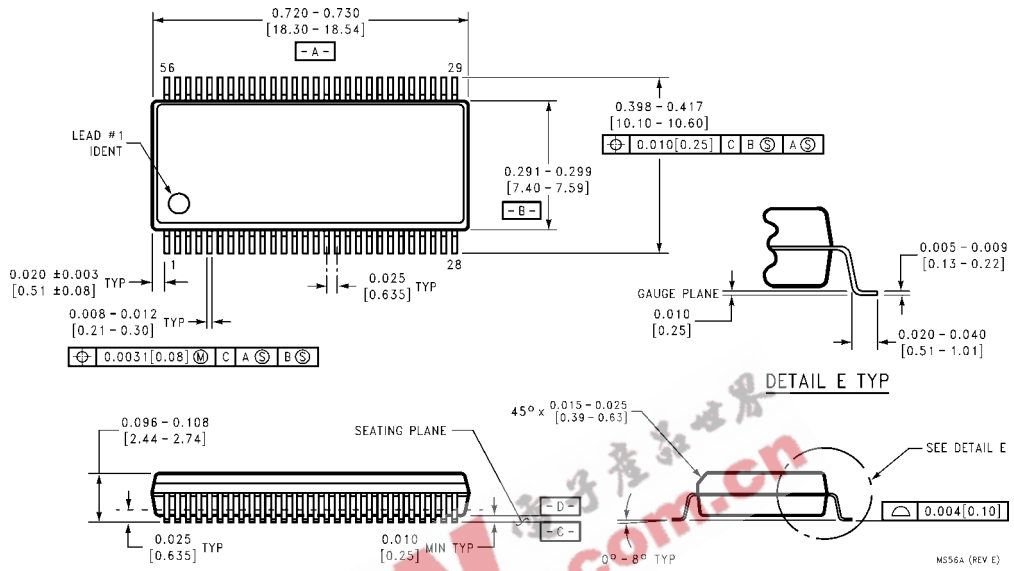

**56-Lead Shrink Small Outline Package (SSOP), JEDEC MO-118, 0.300" Wide  
Package Number MS56A**



**Physical Dimensions** inches (millimeters) unless otherwise noted (Continued)

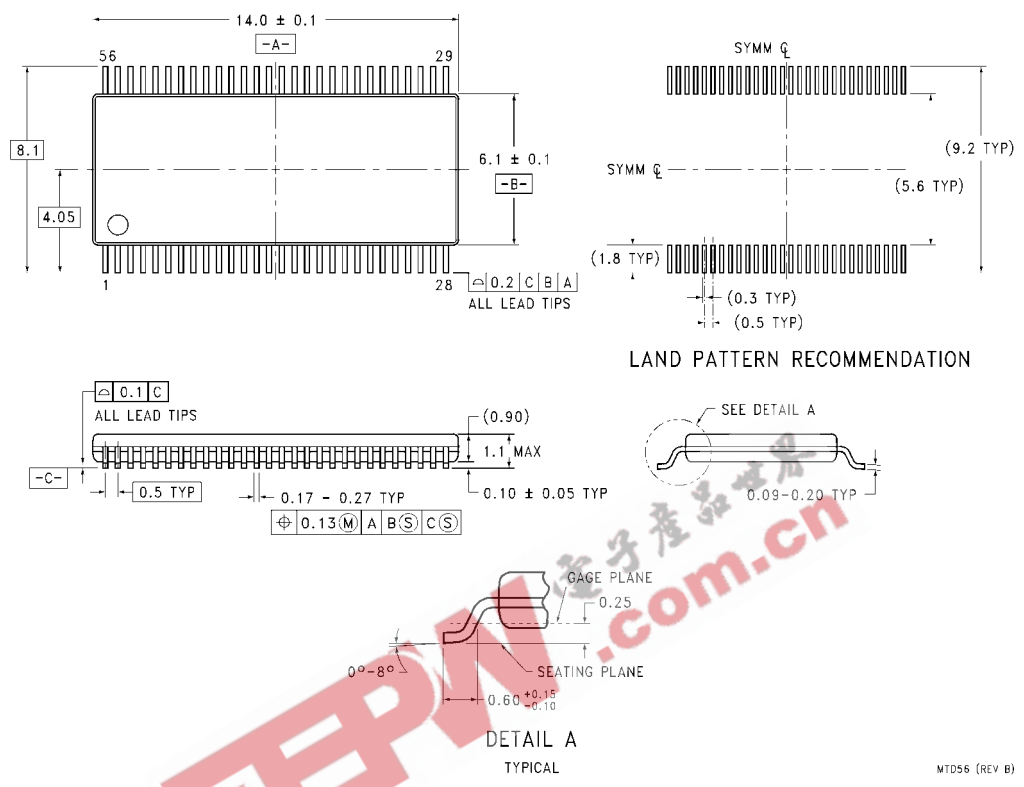

**56-Lead Thin Shrink Small Outline Package (TSSOP), JEDEC MO-153, 6.1mm Wide Package Number MTD56**

MTD56 (REV B)

**LIFE SUPPORT POLICY**

FAIRCHILD'S PRODUCTS ARE NOT AUTHORIZED FOR USE AS CRITICAL COMPONENTS IN LIFE SUPPORT DEVICES OR SYSTEMS WITHOUT THE EXPRESS WRITTEN APPROVAL OF THE PRESIDENT OF FAIRCHILD SEMICONDUCTOR CORPORATION. As used herein:

1. Life support devices or systems are devices or systems which, (a) are intended for surgical implant into the body, or (b) support or sustain life, and (c) whose failure to perform when properly used in accordance with instructions for use provided in the labeling, can be reasonably expected to result in a significant injury to the user.
2. A critical component in any component of a life support device or system whose failure to perform can be reasonably expected to cause the failure of the life support device or system, or to affect its safety or effectiveness.

[www.fairchildsemi.com](http://www.fairchildsemi.com)

Fairchild does not assume any responsibility for use of any circuitry described, no circuit patent licenses are implied and Fairchild reserves the right at any time without notice to change said circuitry and specifications.