

DATA SHEET

For a complete data sheet, please also download:

- The IC06 74HC/HCT/HCU/HCMOS Logic Family Specifications
- The IC06 74HC/HCT/HCU/HCMOS Logic Package Information
- The IC06 74HC/HCT/HCU/HCMOS Logic Package Outlines

EEPW 电子产品世界
.com.cn

74HC/HCT573

Octal D-type transparent latch;
3-state

Product specification
File under Integrated Circuits, IC06

December 1990

Octal D-type transparent latch; 3-state

74HC/HCT573

FEATURES

- Inputs and outputs on opposite sides of package allowing easy interface with microprocessors
- Useful as input or output port for microprocessors/microcomputers
- 3-state non-inverting outputs for bus oriented applications
- Common 3-state output enable input
- Functionally identical to the "563" and "373"
- Output capability: bus driver
- I_{CC} category: MSI

GENERAL DESCRIPTION

The 74HC/HCT573 are high-speed Si-gate CMOS devices and are pin compatible with low power Schottky TTL (LSTTL). They are specified in compliance with JEDEC standard no. 7A.

The 74HC/HCT573 are octal D-type transparent latches featuring separate D-type inputs for each latch and 3-state outputs for bus oriented applications.

A latch enable (LE) input and an output enable (\overline{OE}) input are common to all latches.

The "573" consists of eight D-type transparent latches with 3-state true outputs. When LE is HIGH, data at

the D_n inputs enter the latches. In this condition the latches are transparent, i.e. a latch output will change state each time its corresponding D-input changes.

When LE is LOW the latches store the information that was present at the D-inputs a set-up time preceding the HIGH-to-LOW transition of LE.

When \overline{OE} is LOW, the contents of the 8 latches are available at the outputs. When \overline{OE} is HIGH, the outputs go to the high impedance OFF-state.

Operation of the \overline{OE} input does not affect the state of the latches.

The "573" is functionally identical to the "563" and "373", but the "563" has inverted outputs and the "373" has a different pin arrangement.

QUICK REFERENCE DATA

GND = 0 V; T_{amb} = 25 °C; t_r = t_f = 6 ns

SYMBOL	PARAMETER	CONDITIONS	TYPICAL		UNIT
			HC	HCT	
t _{PHL} / t _{PLH}	propagation delay	C _L = 15 pF; V _{CC} = 5 V			
	D _n to Q _n		14	17	ns
	LE to Q _n		15	15	ns
C _I	input capacitance		3.5	3.5	pF
C _{PD}	power dissipation capacitance per latch	notes 1 and 2	26	26	pF

Notes

1. C_{PD} is used to determine the dynamic power dissipation (P_D in μW):

$$P_D = C_{PD} \times V_{CC}^2 \times f_i + \sum (C_L \times V_{CC}^2 \times f_o) \text{ where:}$$

f_i = input frequency in MHz; f_o = output frequency in MHz

∑ (C_L × V_{CC}² × f_o) = sum of outputs

C_L = output load capacitance in pF; V_{CC} = supply voltage in V

2. For HC the condition is V_I = GND to V_{CC}; for HCT the condition is V_I = GND to V_{CC} - 1.5 V

ORDERING INFORMATION

See "74HC/HCT/HCU/HCMOS Logic Package Information".

Octal D-type transparent latch; 3-state

74HC/HCT573

PIN DESCRIPTION

PIN NO.	SYMBOL	NAME AND FUNCTION
2, 3, 4, 5, 6, 7, 8, 9	D ₀ to D ₇	data inputs
11	LE	latch enable input (active HIGH)
1	\overline{OE}	3-state output enable input (active LOW)
10	GND	ground (0 V)
19, 18, 17, 16, 15, 14, 13, 12	Q ₀ to Q ₇	3-state latch outputs
20	V _{CC}	positive supply voltage

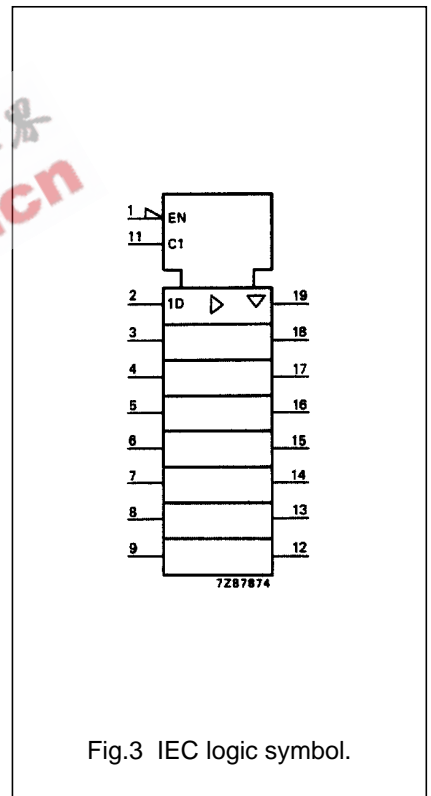
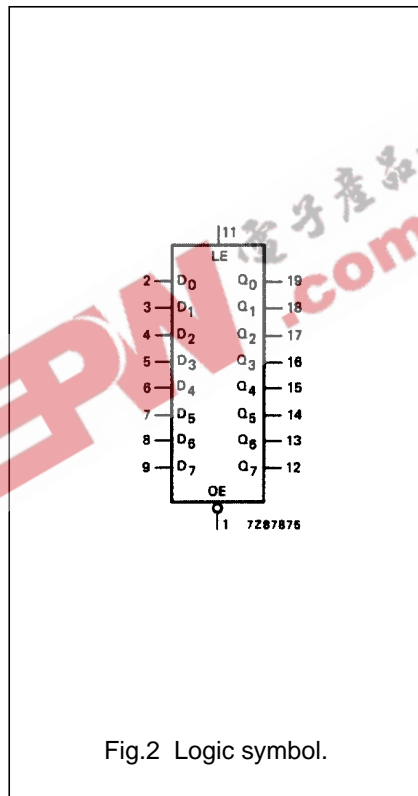
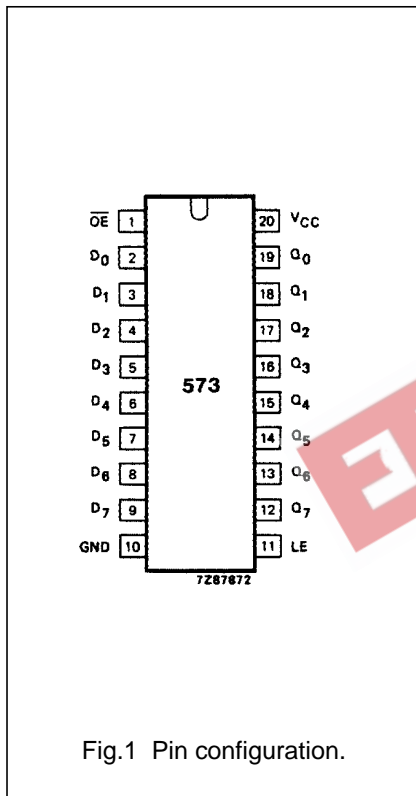

Octal D-type transparent latch; 3-state

74HC/HCT573

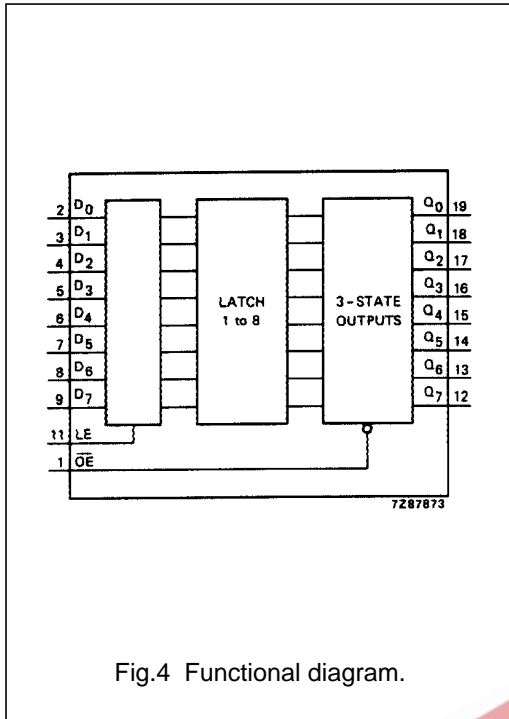

Fig.4 Functional diagram.

FUNCTION TABLE

OPERATING MODES	INPUTS			INTERNAL LATCHES	OUTPUTS Q ₀ to Q ₇
	\overline{OE}	LE	D _N		
enable and read register (transparent mode)	L	H	L	L	L
	L	H	H	H	H
latch and read register	L	L	l	L	L
	L	L	h	H	H
latch register and disable outputs	H	L	l	L	Z
	H	L	h	H	Z

Notes

- H = HIGH voltage level
 h = HIGH voltage level one set-up time prior to the HIGH-to-LOW LE transition
 L = LOW voltage level
 l = LOW voltage level one set-up time prior to the HIGH-to-LOW LE transition
 Z = high impedance OFF-state

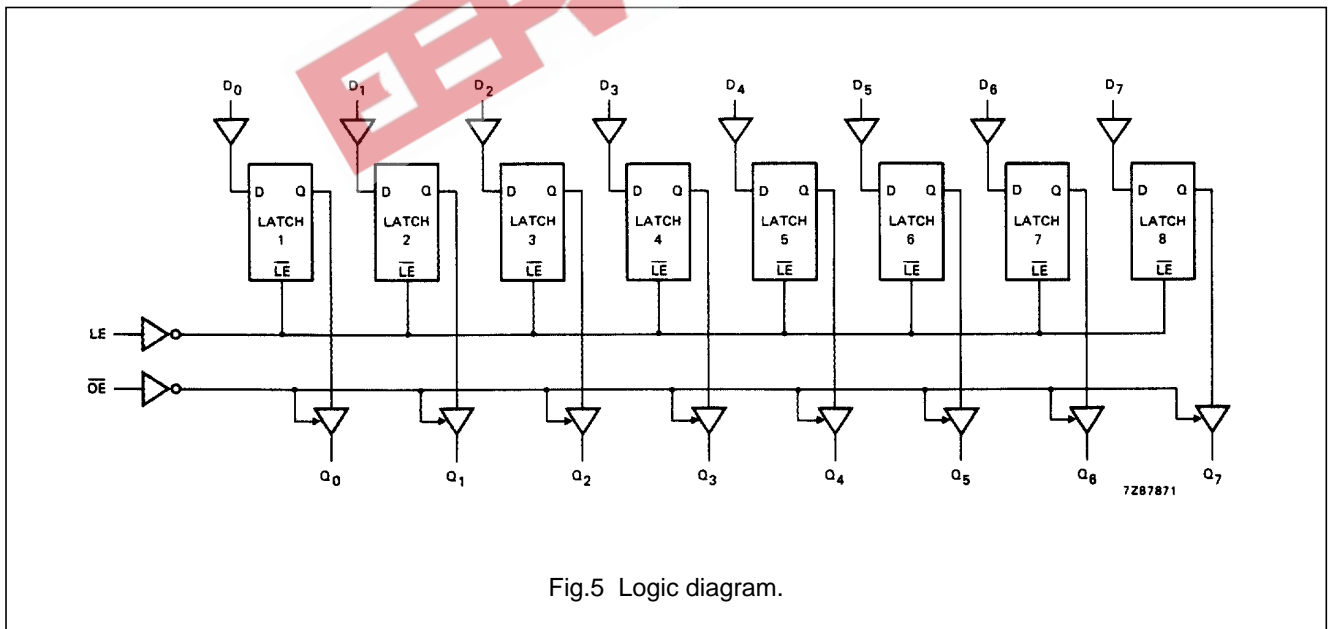

Fig.5 Logic diagram.

Octal D-type transparent latch; 3-state

74HC/HCT573

DC CHARACTERISTICS FOR 74HC

For the DC characteristics see *"74HC/HCT/HCU/HCMOS Logic Family Specifications"*.

Output capability: bus driver

I_{CC} category: MSI

AC CHARACTERISTICS FOR 74HC

GND = 0 V; t_r = t_f = 6 ns; C_L = 50 pF

SYMBOL	PARAMETER	T _{amb} (°C)						UNIT	TEST CONDITIONS		
		74HC							V _{CC} (V)	WAVEFORMS	
		+25			-40 to +85		-40 to +125				
		min.	typ.	max.	min.	max.	min.				max.
t _{PHL} / t _{PLH}	propagation delay D _n to Q _n		47 17 14	150 30 26		190 38 33	225 45 38	ns	2.0 4.5 6.0	Fig.6	
t _{PHL} / t _{PLH}	propagation delay LE to Q _n		50 18 14	150 30 26		190 38 33	225 45 38	ns	2.0 4.5 6.0	Fig.7	
t _{PZH} / t _{PZL}	3-state output enable time \overline{OE} to Q _n		44 16 13	140 28 24		175 35 30	210 42 36	ns	2.0 4.5 6.0	Fig.8	
t _{PHZ} / t _{PLZ}	3-state output disable time \overline{OE} to Q _n		55 20 16	150 30 26		190 38 33	225 45 38	ns	2.0 4.5 6.0	Fig.8	
t _{THL} / t _{TLH}	output transition time		14 5 4	60 12 10		75 15 13	90 18 15	ns	2.0 4.5 6.0	Fig.6	
t _w	enable pulse width HIGH	80 16 14	14 5 4		100 20 17		120 24 20	ns	2.0 4.5 6.0	Fig.7	
t _{su}	set-up time D _n to LE	50 10 9	11 4 3		65 13 11		75 15 13	ns	2.0 4.5 6.0	Fig.9	
t _h	hold time D _n to LE	5 5 5	3 1 1		5 5 5		5 5 5	ns	2.0 4.5 6.0	Fig.9	

Octal D-type transparent latch; 3-state

74HC/HCT573

DC CHARACTERISTICS FOR 74HCT

For the DC characteristics see *"74HC/HCT/HCU/HCMOS Logic Family Specifications"*.

Output capability: bus driver

I_{CC} category: MSI

Note to HCT types

The value of additional quiescent supply current (ΔI_{CC}) for a unit load of 1 is given in the family specifications. To determine ΔI_{CC} per input, multiply this value by the unit load coefficient shown in the table below.

INPUT	UNIT LOAD COEFFICIENT
D _n	0.35
LE	0.65
\overline{OE}	1.25

AC CHARACTERISTICS FOR 74HCT

GND = 0 V; t_r = t_f = 6 ns; C_L = 50 pF

SYMBOL	PARAMETER	T _{amb} (°C)							UNIT	TEST CONDITIONS	
		74HCT								V _{CC} (V)	WAVEFORMS
		+25			-40 to +85		-40 to +125				
		min.	typ.	max.	min.	max.	min.	max.			
t _{PHL} / t _{PLH}	propagation delay D _n to Q _n		20	35		44		53	ns	4.5	Fig.6
t _{PHL} / t _{PLH}	propagation delay LE to Q _n		18	35		44		53	ns	4.5	Fig.7
t _{PZH} / t _{PZL}	3-state output enable time \overline{OE} to Q _n		17	30		38		45	ns	4.5	Fig.8
t _{PHZ} / t _{PLZ}	3-state output disable time \overline{OE} to Q _n		18	30		38		45	ns	4.5	Fig.8
t _{THL} / t _{TLH}	output transition time		5	12		15		18	ns	4.5	Fig.6
t _W	enable pulse width HIGH	16	5		20		24		ns	4.5	Fig.7
t _{SU}	set-up time D _n to LE	13	7		16		20		ns	4.5	Fig.9
t _H	hold time D _n to LE	9	4		11		14		ns	4.5	Fig.9

Octal D-type transparent latch; 3-state

74HC/HCT573

AC WAVEFORMS

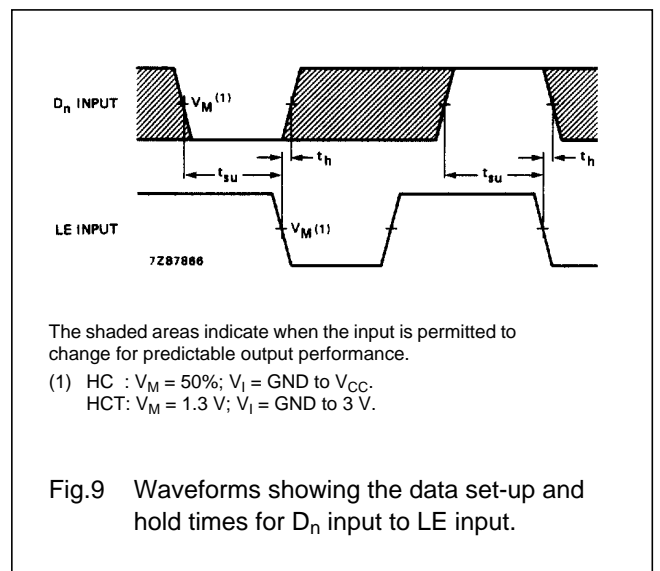
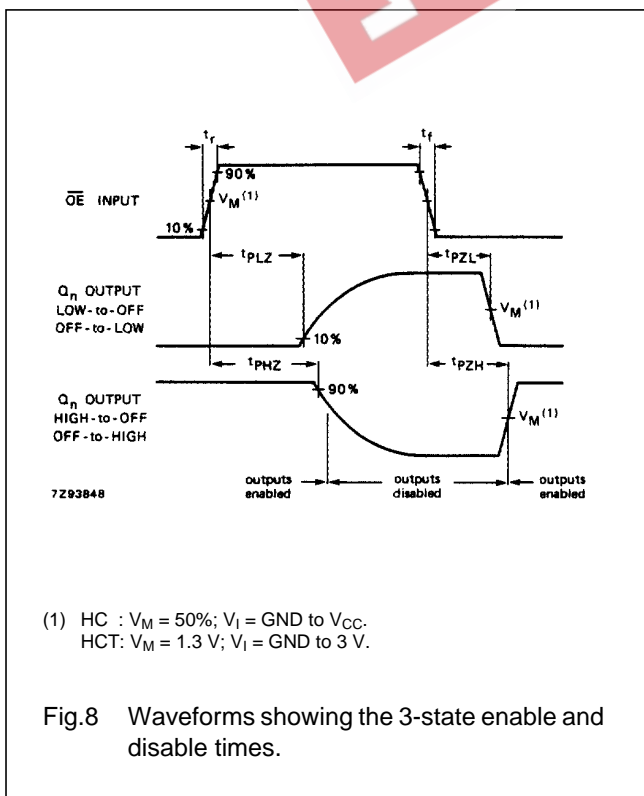
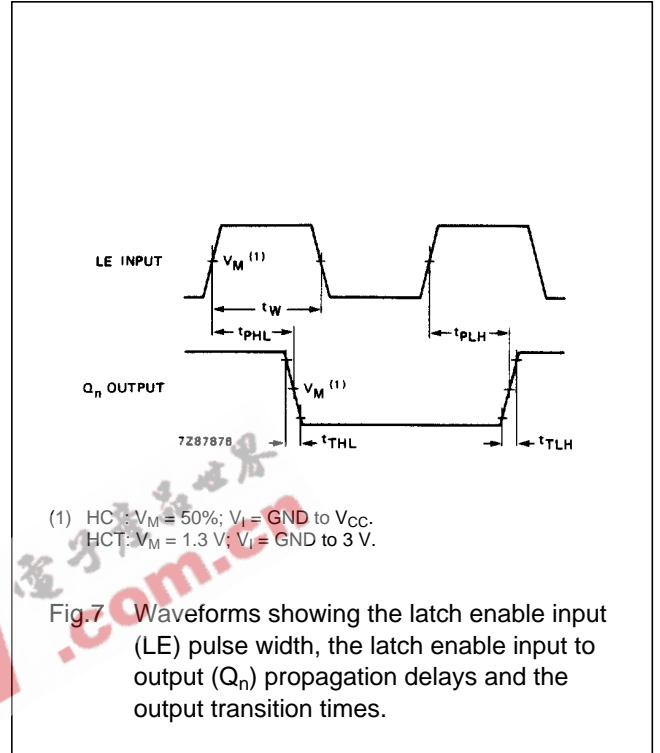
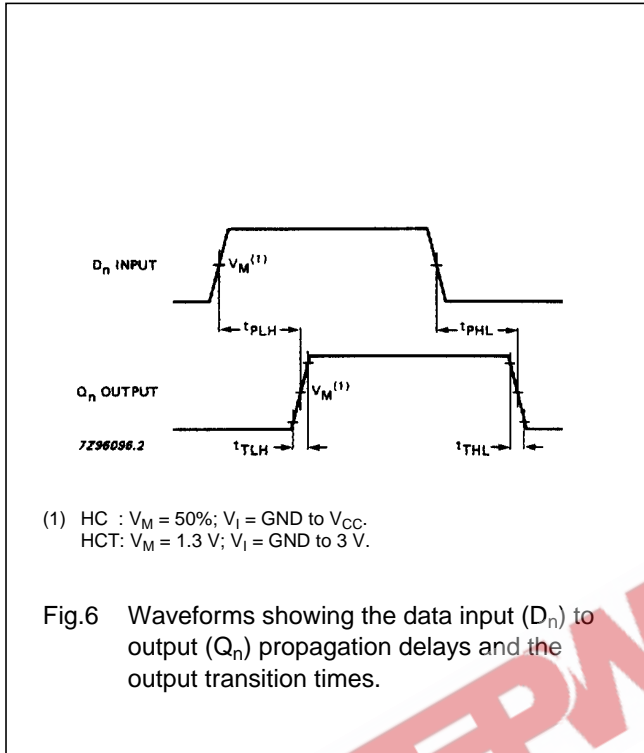

PACKAGE OUTLINES

See "74HC/HCT/HCU/HCMOS Logic Package Outlines".