

DATA SHEET

EEPW 电子產品世界
.com.cn

74LVC32244A; 74LVCH32244A
32-bit buffer/line driver; 5 V
input/output tolerant; 3-state

Product specification
File under Integrated Circuits, IC24

1999 Aug 31

32-bit buffer/line driver; 5 V input/output tolerant; 3-state

74LVC32244A; 74LVCH32244A

FEATURES

- 5 V tolerant inputs/outputs for interfacing with 5 V logic
- Wide supply voltage range of 1.2 to 3.6 V
- CMOS low power consumption
- MULTIBYTE™ flow-through standard pin-out architecture
- Low inductance multiple power and ground pins for minimum noise and ground bounce
- Direct interface with TTL levels
- Bus hold on data inputs (74LVCH32244A only)
- Typical output ground bounce voltage:
 $V_{OLP} < 0.8 \text{ V}$ at $V_{CC} = 3.3 \text{ V}$; $T_{amb} = 25 \text{ }^\circ\text{C}$
- Typical output V_{OH} undershoot voltage:
 $V_{OHV} > 2 \text{ V}$ at $V_{CC} = 3.3 \text{ V}$; $T_{amb} = 25 \text{ }^\circ\text{C}$
- Power-off disabled outputs, permitting live insertion
- Plastic fine-pitch ball grid array package.

DESCRIPTION

The 74LVC(H)32244A is a high-performance, low-power, low-voltage, Si-gate CMOS device, superior to most advanced CMOS compatible TTL families. Inputs can be driven from either 3.3 or 5 V devices. In 3-state operation, outputs can handle 5 V. These features allow the use of these devices in a mixed 3.3 and 5 V environment.

The 74LVC(H)32244A is a 32-bit non-inverting buffer/line driver with 3-state outputs. The 3-state outputs are controlled by the output enable inputs $1\overline{OE}$ and $2\overline{OE}$. A HIGH on input $n\overline{OE}$ causes the outputs to assume a high-impedance OFF-state.

To ensure the high-impedance state during power-up or power-down, input $n\overline{OE}$ should be tied to V_{CC} through a pull-up resistor; the minimum value of the resistor is determined by the current-sinking capability of the driver.

The 74LVCH32244A bus hold data input circuit eliminates the need for external pull-up resistors to hold unused or floating data inputs at a valid logic level (see Fig.3).

QUICK REFERENCE DATA

Ground = 0 V; $T_{amb} = 25 \text{ }^\circ\text{C}$; $t_r = t_f \leq 2.5 \text{ ns}$.

SYMBOL	PARAMETER	CONDITIONS	TYPICAL	UNIT
t_{PHL}/t_{PLH}	propagation delay nA_n to nY_n	$C_L = 50 \text{ pF}$; $V_{CC} = 3.3 \text{ V}$	3.0	ns
C_I	input capacitance		5.0	pF
C_{PD}	power dissipation capacitance per buffer	$V_I = \text{GND to } V_{CC}$; note 1	25	pF

Note

1. C_{PD} is used to determine the dynamic power dissipation (P_D in μW).

$$P_D = C_{PD} \times V_{CC}^2 \times f_i + \Sigma(C_L \times V_{CC}^2 \times f_o) \text{ where:}$$

f_i = input frequency in MHz;

f_o = output frequency in MHz;

C_L = output load capacitance in pF;

V_{CC} = supply voltage in Volts;

$\Sigma(C_L \times V_{CC}^2 \times f_o)$ = sum of the outputs.

32-bit buffer/line driver; 5 V input/output
tolerant; 3-state

74LVC32244A;
74LVCH32244A

FUNCTION TABLE

See note 1.

INPUT		OUTPUT
\overline{nOE}	nA_n	nY_n
L	L	L
L	H	H
H	X	Z

Note

- H = HIGH voltage level;
L = LOW voltage level;
X = don't care;
Z = high-impedance OFF-state.

ORDERING INFORMATION

TYPE NUMBER	PACKAGES				
	TEMPERATURE RANGE	PINS	PACKAGE	MATERIAL	CODE
74LVC32244AEC	-40 to +85 °C	96	LFBGA96	plastic	SOT536-1
74LVCH32244AEC		96	LFBGA96	plastic	SOT536-1

PINNING

SYMBOL	DESCRIPTION
nA_n	data inputs
nY_n	data outputs
GND	ground (0 V)
\overline{nOE}	3-state output enable inputs (active LOW)
V_{CC}	DC supply voltage

32-bit buffer/line driver; 5 V input/output tolerant; 3-state

74LVC32244A;
74LVCH32244A

MNA471

6	1A ₁	1A ₃	2A ₁	2A ₃	3A ₁	3A ₃	4A ₁	4A ₂	5A ₁	5A ₃	6A ₁	6A ₃	7A ₁	7A ₃	8A ₁	8A ₂
5	1A ₀	1A ₂	2A ₀	2A ₂	3A ₀	3A ₂	4A ₀	4A ₃	5A ₀	5A ₂	6A ₀	6A ₂	7A ₀	7A ₂	8A ₀	8A ₃
4	2 $\overline{O}E$	GND	V _{CC}	GND	GND	V _{CC}	GND	3 $\overline{O}E$	6 $\overline{O}E$	GND	V _{CC}	GND	GND	V _{CC}	GND	7 $\overline{O}E$
3	1 $\overline{O}E$	GND	V _{CC}	GND	GND	V _{CC}	GND	4 $\overline{O}E$	5 $\overline{O}E$	GND	V _{CC}	GND	GND	V _{CC}	GND	8 $\overline{O}E$
2	1Y ₀	1Y ₂	2Y ₀	2Y ₂	3Y ₀	3Y ₂	4Y ₀	4Y ₃	5Y ₀	5Y ₂	6Y ₀	6Y ₂	7Y ₀	7Y ₂	8Y ₀	8Y ₃
1	1Y ₁	1Y ₃	2Y ₁	2Y ₃	3Y ₁	3Y ₃	4Y ₁	4Y ₂	5Y ₁	5Y ₃	6Y ₁	6Y ₃	7Y ₁	7Y ₃	8Y ₁	8Y ₂
	A	B	C	D	E	F	G	H	J	K	L	M	N	P	R	T

Fig.1 Pin configuration.

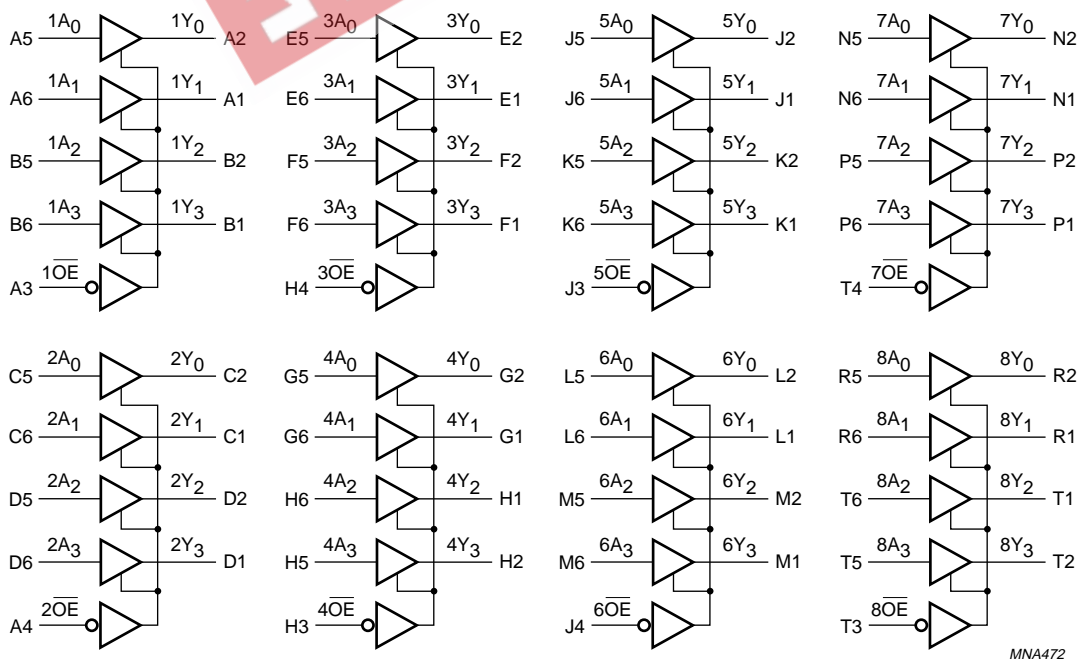

Fig.2 Logic symbol.

32-bit buffer/line driver; 5 V input/output tolerant; 3-state

74LVC32244A;
74LVCH32244A

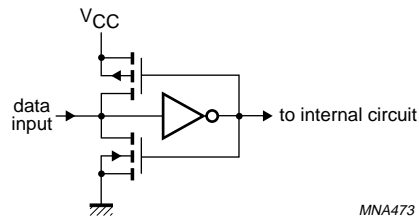

Fig.3 Bus hold circuit.

32-bit buffer/line driver; 5 V input/output tolerant; 3-state

74LVC32244A;
74LVCH32244A

RECOMMENDED OPERATING CONDITIONS

SYMBOL	PARAMETER	CONDITIONS	LIMITS		UNIT
			MIN.	MAX.	
V _{CC}	DC supply voltage	for max. speed performance	2.7	3.6	V
		for low-voltage applications	1.2	3.6	V
V _I	DC input voltage		0	5.5	V
V _O	DC output voltage range;	output HIGH or LOW state	0	V _{CC}	V
		3-state	0	5.5	V
T _{amb}	operating ambient temperature	see DC and AC characteristics per device	-40	+85	°C
t _r , t _f (Δt/Δf)	input rise and fall times ratio	V _{CC} = 1.2 to 2.7 V	0	20	ns/V
		V _{CC} = 2.7 to 3.6 V	0	10	

LIMITING VALUES

In accordance with the Absolute Maximum Rating System (IEC 134); voltages are referenced to GND (ground = 0 V).

SYMBOL	PARAMETER	CONDITIONS	MIN.	MAX.	UNIT
V _{CC}	DC supply voltage		-0.5	+6.5	V
V _I	DC input voltage	note 1	-0.5	+6.5	V
I _{IK}	DC input diode current	V _I < 0	-	-50	mA
I _{OK}	DC output diode current	V _O > V _{CC} or V _O < 0; note 1	-	±50	mA
V _O	DC output voltage	output HIGH or LOW state; note 1	-0.5	V _{CC} + 0.5	V
		output 3-state; note 1	-0.5	+6.5	V
I _O	DC output source or sink current	V _O = 0 to V _{CC}	-	±50	mA
I _{CC} , I _{GND}	DC V _{CC} or GND current		-	±100	mA
T _{stg}	storage temperature		-65	+150	°C
P _D	power dissipation per packages	temperature range: -40 to +85 °C; note 2	-	1000	mW

Notes

1. The input and output voltage ratings may be exceeded if the input and output current ratings are observed.
2. Above 70 °C the value of P_D derates linearly with 1.8 mW/K.

32-bit buffer/line driver; 5 V input/output
tolerant; 3-state74LVC32244A;
74LVCH32244A

DC CHARACTERISTICS

Over recommended operating conditions; voltage are referenced to GND (ground = 0 V).

SYMBOL	PARAMETER	TEST CONDITIONS		T _{amb} (°C)			UNIT
		OTHER	V _{CC} (V)	-40 to +85			
				MIN.	TYP. ⁽¹⁾	MAX.	
V _{IH}	HIGH-level input voltage		1.2	V _{CC}	–	–	V
			2.7 to 3.6	2.0	–	–	
V _{IL}	LOW-level input voltage		1.2	–	–	GND	V
			2.7 to 3.6	–	–	0.8	
V _{OH}	HIGH-level output voltage	V _I = V _{IH} or V _{IL} I _O = –12 mA I _O = –100 μA I _O = –18 mA I _O = –24 mA	2.7	V _{CC} – 0.5	–	–	V
			3.0	V _{CC} – 0.2	V _{CC}	–	
			3.0	V _{CC} – 0.6	–	–	
			3.0	V _{CC} – 0.8	–	–	
V _{OL}	LOW-level output voltage	V _I = V _{IH} or V _{IL} I _O = 12 mA I _O = 100 μA I _O = 24 mA	2.7	–	–	0.40	V
			3.0	–	–	0.20	
			3.0	–	–	0.55	
I _I	input leakage current	V _I = 5.5 V or GND; note 2	3.6	–	±0.1	±5	μA
I _{OZ}	3-state output OFF-state current	V _I = V _{IH} or V _{IL} ; V _O = 5.5 V or GND	3.6	–	0.1	±5	μA
I _{off}	power off leakage supply	V _I or V _O = 5.5 V	0.0	–	0.1	±10	μA
I _{CC}	quiescent supply current	V _I = V _{CC} or GND; I _O = 0	3.6	–	0.1	40	μA
ΔI _{CC}	additional quiescent supply current per input pin	V _I = V _{CC} – 0.6 V; I _O = 0	2.7 to 3.6	–	5	500	μA
I _{BHL}	bus hold LOW sustaining current	V _I = 0.8 V; notes 3, 4 and 5	3.0	75	–	–	μA
I _{BHH}	bus hold HIGH sustaining current	V _I = 2.0 V; notes 3, 4 and 5	3.0	–75	–	–	μA
I _{BHLO}	bus hold LOW overdrive current	notes 3, 4 and 6	3.6	500	–	–	μA
I _{BHHO}	bus hold HIGH overdrive current	notes 3, 4 and 6	3.6	–500	–	–	μA

Notes

1. All typical values are at V_{CC} = 3.3 V and T_{amb} = 25 °C.
2. For bus hold parts the bus hold circuit is switched off when V_I exceeds V_{CC} allowing 5.5 V on the input terminal.
3. Valid for data inputs of bus hold parts only (LVCH32xxx-A).
4. For data inputs only. Control inputs do not have a bus hold circuit.
5. The specified sustaining current at the data input holds the input below the specified V_I level.
6. The specified overdrive current at the data input forces the data input to the opposite logic input level.

32-bit buffer/line driver; 5 V input/output tolerant; 3-state

74LVC32244A;
74LVCH32244A

AC CHARACTERISTICS

Ground = 0 V; $t_r = t_f \leq 2.5$ ns; $C_L = 50$ pF; $R_L = 500 \Omega$.

SYMBOL	PARAMETER	TEST CONDITIONS		$T_{amb} = -40$ to $+85$ °C			UNIT
		WAVEFORMS	V_{CC} (V)	MIN.	TYP. ⁽¹⁾	MAX.	
t_{PHL}/t_{PLH}	propagation delay nA_n to nY_n	see Figs 4 and 6	2.7	1.5	–	5.5	ns
			3.0 to 3.6	1.5	3.0	4.5	
t_{PZH}/t_{PZL}	3-state output enable time $n\overline{OE}$ to nY_n	see Figs 5 and 6	2.7	1.5	–	6.5	ns
			3.0 to 3.6	1.5	3.5	5.5	
t_{PHZ}/t_{PLZ}	3-state output disable time $n\overline{OE}$ to nY_n	see Figs 5 and 6	2.7	1.5	–	6.2	ns
			3.0 to 3.6	1.5	3.7	5.2	

Notes

1. All typical values are measured at $V_{CC} = 3.3$ V and $T_{amb} = 25$ °C.

AC WAVEFORMS

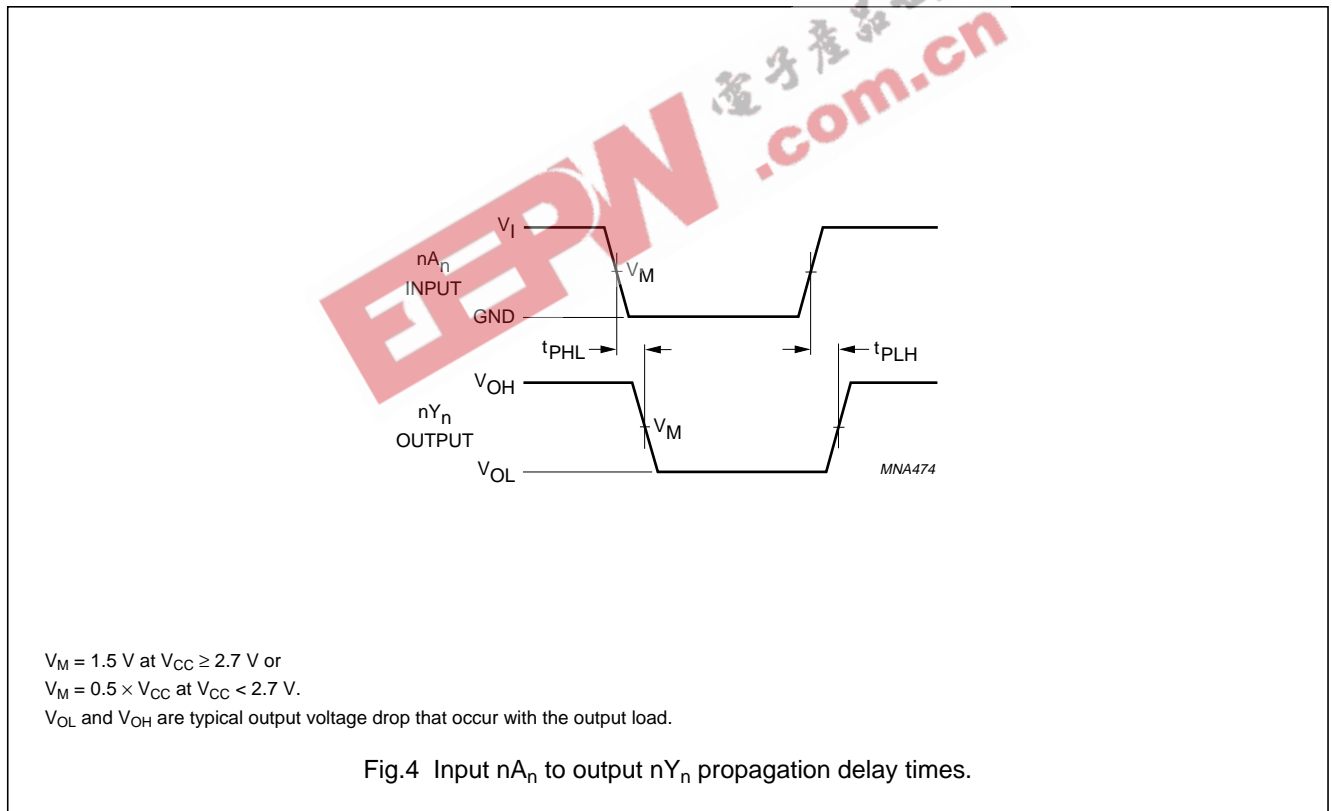

32-bit buffer/line driver; 5 V input/output tolerant; 3-state

74LVC32244A;
74LVCH32244A

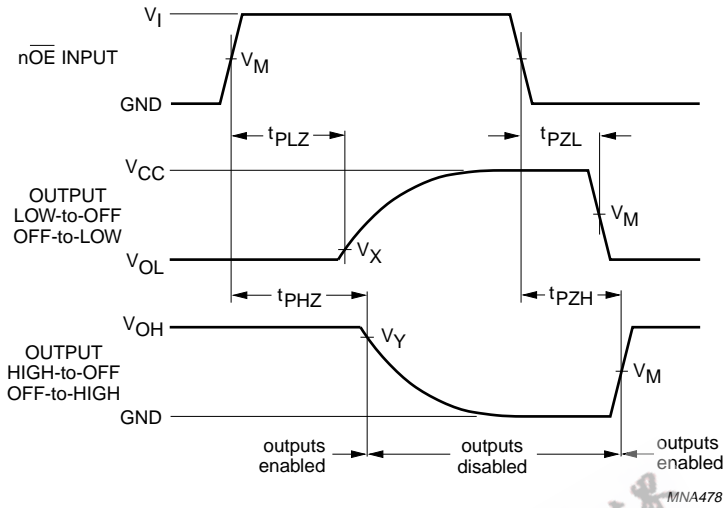

$V_M = 1.5\text{ V}$ at $V_{CC} \geq 2.7\text{ V}$ or
 $V_M = 0.5 \times V_{CC}$ at $V_{CC} < 2.7\text{ V}$;
 $V_X = V_{OL} + 0.3\text{ V}$ at $V_{CC} \geq 2.7\text{ V}$ or
 $V_X = V_{OL} + 0.1\text{ V}$ at $V_{CC} < 2.7\text{ V}$;
 $V_Y = V_{OH} - 0.3\text{ V}$ at $V_{CC} \geq 2.7\text{ V}$ or
 $V_Y = V_{OH} - 0.1\text{ V}$ at $V_{CC} < 2.7\text{ V}$.

V_{OL} and V_{OH} are typical output voltage drop that occur with the output load.

Fig.5 3-state enable and disable times.

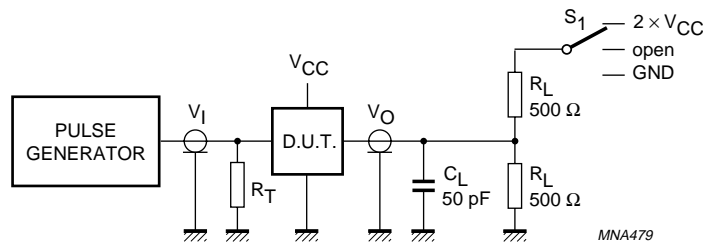

TEST	S ₁
t _{PLH} /t _{PHL}	open
t _{PLZ} /t _{PZL}	2 × V _{CC}
t _{PHZ} /t _{PZH}	GND

V _{CC}	V _I
< 2.7 V	V _{CC}
2.7 to 3.6 V	2.7 V

Definitions for test circuit:

R_L = load resistor.

C_L = load capacitance including jig and probe capacitance.

R_T = termination resistance should be equal to the output impedance Z_o of the pulse generator.

Fig.6 Load circuitry for switching times.

32-bit buffer/line driver; 5 V input/output tolerant; 3-state

74LVC32244A;
74LVCH32244A

PACKAGE OUTLINE

LFBGA96: plastic low profile fine-pitch ball grid array package; 96 balls; body 13.5 x 5.5 x 1.05 mm SOT536-1

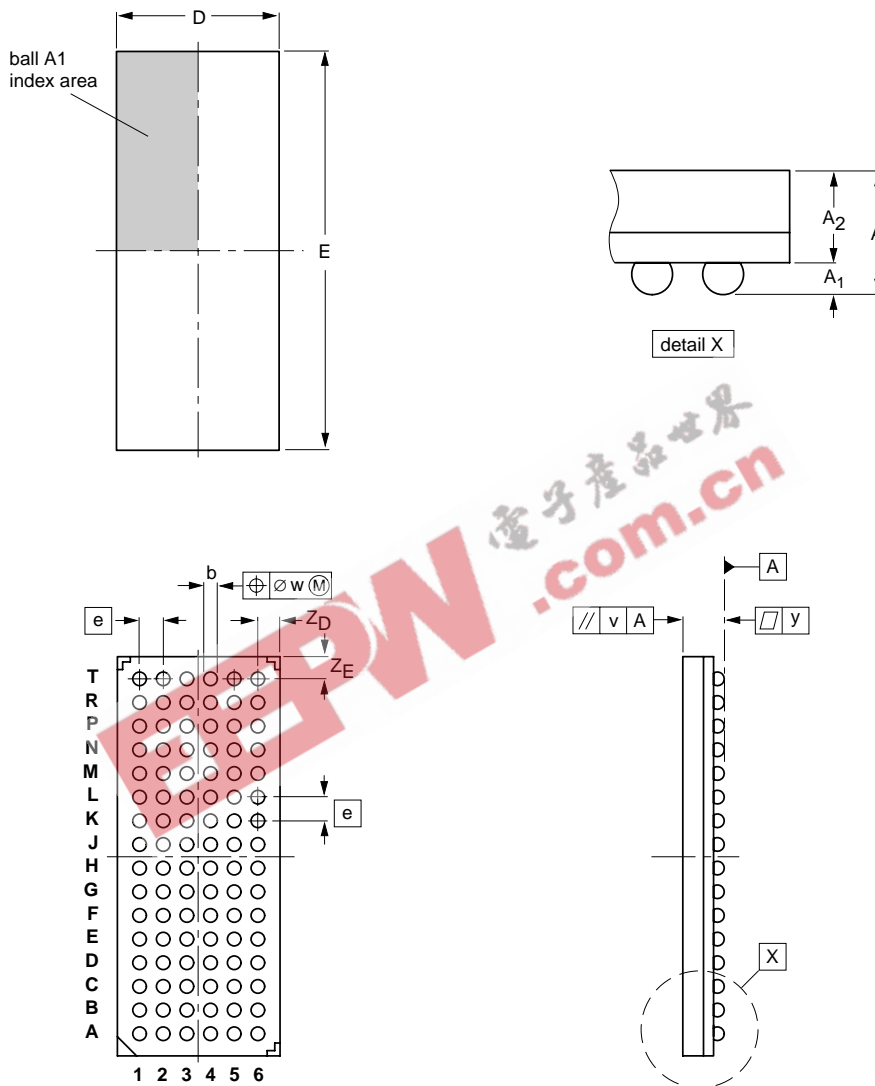

DIMENSIONS (mm are the original dimensions)

UNIT	A max.	A ₁	A ₂	b	D	E	e	v	w	y	Z _D	Z _E
mm	1.5	0.41 0.31	1.2 0.9	0.51 0.41	5.6 5.4	13.6 13.4	0.8	0.2	0.15	0.1	0.93 0.58	0.93 0.58

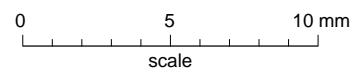

OUTLINE VERSION	REFERENCES				EUROPEAN PROJECTION	ISSUE DATE
	IEC	JEDEC	EIAJ			
SOT536-1						98-11-25 99-06-03

32-bit buffer/line driver; 5 V input/output tolerant; 3-state

74LVC32244A;
74LVCH32244A

SOLDERING

Introduction to soldering surface mount packages

This text gives a very brief insight to a complex technology. A more in-depth account of soldering ICs can be found in our "Data Handbook IC26; Integrated Circuit Packages" (document order number 9398 652 90011).

There is no soldering method that is ideal for all surface mount IC packages. Wave soldering is not always suitable for surface mount ICs, or for printed-circuit boards with high population densities. In these situations reflow soldering is often used.

Reflow soldering

Reflow soldering requires solder paste (a suspension of fine solder particles, flux and binding agent) to be applied to the printed-circuit board by screen printing, stencilling or pressure-syringe dispensing before package placement.

Several methods exist for reflowing; for example, infrared/convection heating in a conveyor type oven. Throughput times (preheating, soldering and cooling) vary between 100 and 200 seconds depending on heating method.

Typical reflow peak temperatures range from 215 to 250 °C. The top-surface temperature of the packages should preferably be kept below 230 °C.

Wave soldering

Conventional single wave soldering is not recommended for surface mount devices (SMDs) or printed-circuit boards with a high component density, as solder bridging and non-wetting can present major problems.

To overcome these problems the double-wave soldering method was specifically developed.

If wave soldering is used the following conditions must be observed for optimal results:

- Use a double-wave soldering method comprising a turbulent wave with high upward pressure followed by a smooth laminar wave.
- For packages with leads on two sides and a pitch (e):
 - larger than or equal to 1.27 mm, the footprint longitudinal axis is **preferred** to be parallel to the transport direction of the printed-circuit board;
 - smaller than 1.27 mm, the footprint longitudinal axis **must** be parallel to the transport direction of the printed-circuit board.

The footprint must incorporate solder thieves at the downstream end.

- For packages with leads on four sides, the footprint must be placed at a 45° angle to the transport direction of the printed-circuit board. The footprint must incorporate solder thieves downstream and at the side corners.

During placement and before soldering, the package must be fixed with a droplet of adhesive. The adhesive can be applied by screen printing, pin transfer or syringe dispensing. The package can be soldered after the adhesive is cured.

Typical dwell time is 4 seconds at 250 °C.

A mildly-activated flux will eliminate the need for removal of corrosive residues in most applications.

Manual soldering

Fix the component by first soldering two diagonally-opposite end leads. Use a low voltage (24 V or less) soldering iron applied to the flat part of the lead. Contact time must be limited to 10 seconds at up to 300 °C.

When using a dedicated tool, all other leads can be soldered in one operation within 2 to 5 seconds between 270 and 320 °C.

32-bit buffer/line driver; 5 V input/output
tolerant; 3-state

74LVC32244A;
74LVCH32244A

Suitability of surface mount IC packages for wave and reflow soldering methods

PACKAGE	SOLDERING METHOD	
	WAVE	REFLOW ⁽¹⁾
BGA, LFBGA, SQFP, TFBGA	not suitable	suitable
HLQFP, HSQFP, HSOP, HTQFP, HTSSOP, SMS	not suitable ⁽²⁾	suitable
PLCC ⁽³⁾ , SO, SOJ	suitable	suitable
LQFP, QFP, TQFP	not recommended ⁽³⁾⁽⁴⁾	suitable
SSOP, TSSOP, VSO	not recommended ⁽⁵⁾	suitable

Notes

- All surface mount (SMD) packages are moisture sensitive. Depending upon the moisture content, the maximum temperature (with respect to time) and body size of the package, there is a risk that internal or external package cracks may occur due to vaporization of the moisture in them (the so called popcorn effect). For details, refer to the Drypack information in the "Data Handbook IC26; Integrated Circuit Packages; Section: Packing Methods".
- These packages are not suitable for wave soldering as a solder joint between the printed-circuit board and heatsink (at bottom version) can not be achieved, and as solder may stick to the heatsink (on top version).
- If wave soldering is considered, then the package must be placed at a 45° angle to the solder wave direction. The package footprint must incorporate solder thieves downstream and at the side corners.
- Wave soldering is only suitable for LQFP, TQFP and QFP packages with a pitch (e) equal to or larger than 0.8 mm; it is definitely not suitable for packages with a pitch (e) equal to or smaller than 0.65 mm.
- Wave soldering is only suitable for SSOP and TSSOP packages with a pitch (e) equal to or larger than 0.65 mm; it is definitely not suitable for packages with a pitch (e) equal to or smaller than 0.5 mm.

DEFINITIONS

Data sheet status	
Objective specification	This data sheet contains target or goal specifications for product development.
Preliminary specification	This data sheet contains preliminary data; supplementary data may be published later.
Product specification	This data sheet contains final product specifications.
Limiting values	
Limiting values given are in accordance with the Absolute Maximum Rating System (IEC 134). Stress above one or more of the limiting values may cause permanent damage to the device. These are stress ratings only and operation of the device at these or at any other conditions above those given in the Characteristics sections of the specification is not implied. Exposure to limiting values for extended periods may affect device reliability.	
Application information	
Where application information is given, it is advisory and does not form part of the specification.	

LIFE SUPPORT APPLICATIONS

These products are not designed for use in life support appliances, devices, or systems where malfunction of these products can reasonably be expected to result in personal injury. Philips customers using or selling these products for use in such applications do so at their own risk and agree to fully indemnify Philips for any damages resulting from such improper use or sale.

32-bit buffer/line driver; 5 V input/output
tolerant; 3-state

74LVC32244A;
74LVCH32244A

NOTES



32-bit buffer/line driver; 5 V input/output
tolerant; 3-state

74LVC32244A;
74LVCH32244A

NOTES



32-bit buffer/line driver; 5 V input/output
tolerant; 3-state

74LVC32244A;
74LVCH32244A

NOTES



Philips Semiconductors – a worldwide company

Argentina: see South America

Australia: 3 Figtree Drive, HOMEBUSH, NSW 2140,
Tel. +61 2 9704 8141, Fax. +61 2 9704 8139

Austria: Computerstr. 6, A-1101 WIEN, P.O. Box 213,
Tel. +43 1 60 101 1248, Fax. +43 1 60 101 1210

Belarus: Hotel Minsk Business Center, Bld. 3, r. 1211, Volodarski Str. 6,
220050 MINSK, Tel. +375 172 20 0733, Fax. +375 172 20 0773

Belgium: see The Netherlands

Brazil: see South America

Bulgaria: Philips Bulgaria Ltd., Energoproject, 15th floor,
51 James Bourchier Blvd., 1407 SOFIA,
Tel. +359 2 68 9211, Fax. +359 2 68 9102

Canada: PHILIPS SEMICONDUCTORS/COMPONENTS,
Tel. +1 800 234 7381, Fax. +1 800 943 0087

China/Hong Kong: 501 Hong Kong Industrial Technology Centre,
72 Tat Chee Avenue, Kowloon Tong, HONG KONG,
Tel. +852 2319 7888, Fax. +852 2319 7700

Colombia: see South America

Czech Republic: see Austria

Denmark: Sydhavnsgade 23, 1780 COPENHAGEN V,
Tel. +45 33 29 3333, Fax. +45 33 29 3905

Finland: Sinikalliontie 3, FIN-02630 ESPOO,
Tel. +358 9 615 800, Fax. +358 9 6158 0920

France: 51 Rue Carnot, BP317, 92156 SURESNES Cedex,
Tel. +33 1 4099 6161, Fax. +33 1 4099 6427

Germany: Hammerbrookstraße 69, D-20097 HAMBURG,
Tel. +49 40 2353 60, Fax. +49 40 2353 6300

Hungary: see Austria

India: Philips INDIA Ltd, Band Box Building, 2nd floor,
254-D, Dr. Annie Besant Road, Worli, MUMBAI 400 025,
Tel. +91 22 493 8541, Fax. +91 22 493 0966

Indonesia: PT Philips Development Corporation, Semiconductors Division,
Gedung Philips, Jl. Buncit Raya Kav.99-100, JAKARTA 12510,
Tel. +62 21 794 0040 ext. 2501, Fax. +62 21 794 0080

Ireland: Newstead, Clonskeagh, DUBLIN 14,
Tel. +353 1 7640 000, Fax. +353 1 7640 200

Israel: RAPAC Electronics, 7 Kehilat Saloniki St, PO Box 18053,
TEL AVIV 61180, Tel. +972 3 645 0444, Fax. +972 3 649 1007

Italy: PHILIPS SEMICONDUCTORS, Via Casati, 23 - 20052 MONZA (MI),
Tel. +39 039 203 6838, Fax +39 039 203 6800

Japan: Philips Bldg 13-37, Kohnan 2-chome, Minato-ku,
TOKYO 108-8507, Tel. +81 3 3740 5130, Fax. +81 3 3740 5057

Korea: Philips House, 260-199 Itaewon-dong, Yongsan-ku, SEOUL,
Tel. +82 2 709 1412, Fax. +82 2 709 1415

Malaysia: No. 76 Jalan Universiti, 46200 PETALING JAYA, SELANGOR,
Tel. +60 3 750 5214, Fax. +60 3 757 4880

Mexico: 5900 Gateway East, Suite 200, EL PASO, TEXAS 79905,
Tel. +9-5 800 234 7381, Fax +9-5 800 943 0087

Middle East: see Italy

Netherlands: Postbus 90050, 5600 PB EINDHOVEN, Bldg. VB,
Tel. +31 40 27 82785, Fax. +31 40 27 88399

New Zealand: 2 Wagener Place, C.P.O. Box 1041, AUCKLAND,
Tel. +64 9 849 4160, Fax. +64 9 849 7811

Norway: Box 1, Manglerud 0612, OSLO,
Tel. +47 22 74 8000, Fax. +47 22 74 8341

Pakistan: see Singapore

Philippines: Philips Semiconductors Philippines Inc.,
106 Valero St. Salcedo Village, P.O. Box 2108 MCC, MAKATI,
Metro MANILA, Tel. +63 2 816 6380, Fax. +63 2 817 3474

Poland: Ul. Lukiska 10, PL 04-123 WARSZAWA,
Tel. +48 22 612 2831, Fax. +48 22 612 2327

Portugal: see Spain

Romania: see Italy

Russia: Philips Russia, Ul. Usatcheva 35A, 119048 MOSCOW,
Tel. +7 095 755 6918, Fax. +7 095 755 6919

Singapore: Lorong 1, Toa Payoh, SINGAPORE 319762,
Tel. +65 350 2538, Fax. +65 251 6500

Slovakia: see Austria

Slovenia: see Italy

South Africa: S.A. PHILIPS Pty Ltd., 195-215 Main Road Martindale,
2092 JOHANNESBURG, P.O. Box 58088 Newville 2114,
Tel. +27 11 471 5401, Fax. +27 11 471 5398

South America: Al. Vicente Pinzon, 173, 6th floor,
04547-130 SÃO PAULO, SP, Brazil,
Tel. +55 11 821 2333, Fax. +55 11 821 2382

Spain: Balmes 22, 08007 BARCELONA,
Tel. +34 93 301 6312, Fax. +34 93 301 4107

Sweden: Kottbygatan 7, Akalla, S-16485 STOCKHOLM,
Tel. +46 8 5985 2000, Fax. +46 8 5985 2745

Switzerland: Allmendstrasse 140, CH-8027 ZÜRICH,
Tel. +41 1 488 2741 Fax. +41 1 488 3263

Taiwan: Philips Semiconductors, 6F, No. 96, Chien Kuo N. Rd., Sec. 1,
TAIPEI, Taiwan Tel. +886 2 2134 2886, Fax. +886 2 2134 2874

Thailand: PHILIPS ELECTRONICS (THAILAND) Ltd.,
209/2 Sanpavuth-Bangna Road Prakanong, BANGKOK 10260,
Tel. +66 2 745 4090, Fax. +66 2 398 0793

Turkey: Yukari Dudullu, Org. San. Blg., 2.Cad. Nr. 28 81260 Umraniye,
ISTANBUL, Tel. +90 216 522 1500, Fax. +90 216 522 1813

Ukraine: PHILIPS UKRAINE, 4 Patrice Lumumba str., Building B, Floor 7,
252042 KIEV, Tel. +380 44 264 2776, Fax. +380 44 268 0461

United Kingdom: Philips Semiconductors Ltd., 276 Bath Road, Hayes,
MIDDLESEX UB3 5BX, Tel. +44 208 730 5000, Fax. +44 208 754 8421

United States: 811 East Arques Avenue, SUNNYVALE, CA 94088-3409,
Tel. +1 800 234 7381, Fax. +1 800 943 0087

Uruguay: see South America

Vietnam: see Singapore

Yugoslavia: PHILIPS, Trg N. Pasica 5/v, 11000 BEOGRAD,
Tel. +381 11 62 5344, Fax. +381 11 63 5777

For all other countries apply to: Philips Semiconductors,
International Marketing & Sales Communications, Building BE-p, P.O. Box 218,
5600 MD EINDHOVEN, The Netherlands, Fax. +31 40 27 24825

Internet: <http://www.semiconductors.philips.com>

© Philips Electronics N.V. 1999

SCA 67

All rights are reserved. Reproduction in whole or in part is prohibited without the prior written consent of the copyright owner.

The information presented in this document does not form part of any quotation or contract, is believed to be accurate and reliable and may be changed without notice. No liability will be accepted by the publisher for any consequence of its use. Publication thereof does not convey nor imply any license under patent- or other industrial or intellectual property rights.

Printed in The Netherlands

245004/01/pp16

Date of release: 1999 Aug 31

Document order number: 9397 750 06258

Let's make things better.

Philips
Semiconductors



PHILIPS