

74LVTH543

Low Voltage Octal Registered Transceiver with 3-STATE Outputs

General Description

The LVTH543 octal transceiver contains two sets of D-type latches for temporary storage of data flowing in either direction. Separate Latch Enable and Output Enable inputs are provided for each register to permit independent control of inputting and outputting in either direction of data flow.

The LVTH543 data inputs include bushold, eliminating the need for external pull-up resistors to hold unused inputs.

This octal registered transceiver is designed for low-voltage (3.3V) V_{CC} applications, but with the capability to provide a TTL interface to a 5V environment. The LVTH543 is fabricated with an advanced BiCMOS technology to achieve high speed operation similar to 5V ABT while maintaining a low power dissipation.

Features

- Input and output interface capability to systems at 5V V_{CC}
- Bushold data inputs eliminate the need for external pull-up resistors to hold unused inputs
- Live insertion/extraction permitted
- Power Up/Down high impedance provides glitch-free bus loading
- Outputs source/sink $-32\text{ mA}/+64\text{ mA}$
- Functionally compatible with the 74 series 543
- Latch-up performance exceeds 500 mA

Ordering Code:

Order Number	Package Number	Package Description
74LVTH543WM	M24B	24-Lead Small Outline Integrated Circuit (SOIC), JEDEC MS-013, 0.300" Wide
74LVTH543MTC	MTC24	24-Lead Thin Shrink Small Outline Package (TSSOP), JEDEC MO-153, 4.4mm Wide

Device also available in Tape and Reel. Specify by appending suffix letter "X" to the ordering code.

Connection Diagram

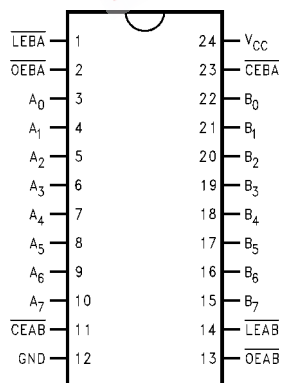

Pin Descriptions

Pin Names	Description
\overline{OEAB} , \overline{OEBA}	Output Enable Inputs
\overline{LEAB} , \overline{LEBA}	Latch Enable Inputs
\overline{CEAB} , \overline{CEBA}	Chip Enable Inputs
A_0 - A_7	Side A Inputs or 3-STATE Outputs
B_0 - B_7	Side B Inputs or 3-STATE Outputs

Logic Symbols

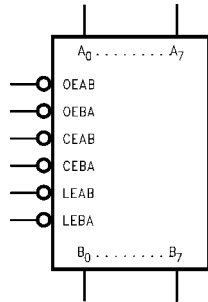

Functional Description

The LVTH543 contains two sets of D-type latches, with separate input and output controls for each. For data flow from A to B, for example, the A to B Enable (CEAB) input must be LOW in order to enter data from the A Port or take data from the B Port as indicated in the Data I/O Control Table. With CEAB LOW, a low signal on (LEAB) input makes the A to B latches transparent; a subsequent LOW-to-HIGH transition of the LEAB line puts the A latches in the storage mode and their outputs no longer change with the A inputs. With CEAB and OEAB both LOW, the B output buffers are active and reflect the data present on the output of the A latches. Control of data flow from B to A is similar, but using the CEBA, LEBA and OEBA.

Data I/O Control Table

Inputs			Latch Status	Output Buffers
CEAB	LEAB	OEAB		
H	X	X	Latched	High Z
X	H	X	Latched	—
L	L	X	Transparent	—
X	X	H	—	High Z
L	X	L	—	Driving

H = HIGH Voltage Level
L = LOW Voltage Level
X = Immaterial

Note: A-to-B data flow shown; B-to-A flow control is the same, except using CEBA, LEBA, and OEBA.

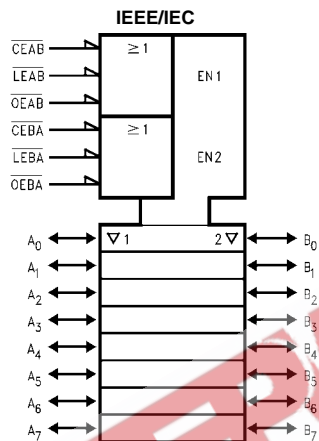

Logic Diagram

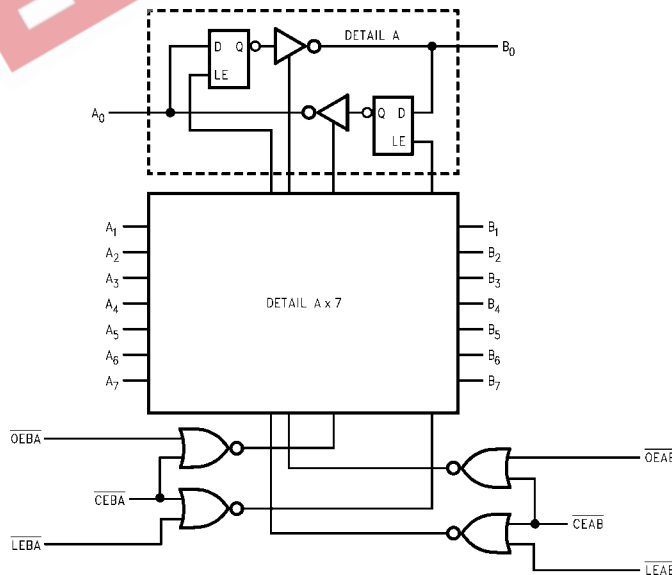

Please note that this diagram is provided only for the understanding of logic operations and should not be used to estimate propagation delays.

Absolute Maximum Ratings (Note 1)				
Symbol	Parameter	Value	Conditions	Units
V_{CC}	Supply Voltage	-0.5 to +4.6		V
V_I	DC Input Voltage	-0.5 to +7.0		V
V_O	DC Output Voltage	-0.5 to +7.0	Output in 3-STATE	V
		-0.5 to +7.0	Output in HIGH or LOW State (Note 2)	V
I_{IK}	DC Input Diode Current	-50	$V_I < GND$	mA
I_{OK}	DC Output Diode Current	-50	$V_O < GND$	mA
I_O	DC Output Current	64	$V_O > V_{CC}$ Output at HIGH State	mA
		128	$V_O > V_{CC}$ Output at LOW State	
I_{CC}	DC Supply Current per Supply Pin	± 64		mA
I_{GND}	DC Ground Current per Ground Pin	± 128		mA
T_{STG}	Storage Temperature	-65 to +150		$^{\circ}C$
Recommended Operating Conditions				
Symbol	Parameter	Min	Max	Units
V_{CC}	Supply Voltage	2.7	3.6	V
V_I	Input Voltage	0	5.5	V
I_{OH}	HIGH Level Output Current		-32	mA
I_{OL}	LOW Level Output Current		64	
T_A	Free-Air Operating Temperature	-40	85	$^{\circ}C$
$\Delta t/\Delta V$	Input Edge Rate, $V_{IN} = 0.8V-2.0V$, $V_{CC} = 3.0V$	0	10	ns/V
<p>Note 1: Absolute Maximum continuous ratings are those values beyond which damage to the device may occur. Exposure to these conditions or conditions beyond those indicated may adversely affect device reliability. Functional operation under absolute maximum rated conditions is not implied.</p> <p>Note 2: I_O Absolute Maximum Rating must be observed.</p>				

DC Electrical Characteristics							
Symbol	Parameter	V _{CC} (V)	T _A = -40°C to +85°C		Units	Conditions	
			Min	Max			
V _{IK}	Input Clamp Diode Voltage	2.7		-1.2	V	I _I = -18 mA	
V _{IH}	Input HIGH Voltage	2.7-3.6	2.0		V	V _O ≤ 0.1V or	
V _{IL}	Input LOW Voltage	2.7-3.6		0.8		V _O ≥ V _{CC} - 0.1V	
V _{OH}	Output HIGH Voltage	2.7-3.6	V _{CC} - 0.2		V	I _{OH} = -100 μA	
		2.7	2.4		V	I _{OH} = -8 mA	
		3.0	2.0		V	I _{OH} = -32 mA	
V _{OL}	Output LOW Voltage	2.7		0.2	V	I _{OL} = 100 μA	
		2.7		0.5	V	I _{OL} = 24 mA	
		3.0		0.4	V	I _{OL} = 16 mA	
		3.0		0.5	V	I _{OL} = 32 mA	
		3.0		0.55	V	I _{OL} = 64 mA	
I _{I(HOLD)}	Bushold Input Minimum Drive	3.0	75		μA	V _I = 0.8V	
I _{I(OD)}	Bushold Input Over-Drive Current to Change State	3.0	-75		μA	V _I = 2.0V	
			-500		μA	(Note 3)	
I _I	Input Current	3.6		10	μA	V _I = 5.5V	
		Control Pins	3.6		±1	μA	V _I = 0V or V _{CC}
		Data Pins	3.6		-5	μA	V _I = 0V
					1	μA	V _I = V _{CC}
I _{OFF}	Power Off Leakage Current	0		±100	μA	0V ≤ V _I or V _O ≤ 5.5V	
I _{PU/PD}	Power Up/Down 3-STATE Output Current	0-1.5V		±100	μA	V _O = 0.5V to 3.0V V _I = GND or V _{CC}	
I _{OZL}	3-STATE Output Leakage Current	3.6		-5	μA	V _O = 0.0V	
I _{OZH}	3-STATE Output Leakage Current	3.6		5	μA	V _O = 3.6V	
I _{OZH+}	3-STATE Output Leakage Current	3.6		10	μA	V _{CC} < V _O ≤ 5.5V	
I _{CCH}	Power Supply Current	3.6		0.19	mA	Outputs HIGH	
I _{CCL}	Power Supply Current	3.6		5	mA	A or B Port Outputs LOW	
I _{CCZ}	Power Supply Current	3.6		0.19	mA	Outputs Disabled	
I _{CCZ+}	Power Supply Current	3.6		0.19	mA	V _{CC} ≤ V _O ≤ 5.5V Outputs Disabled	
ΔI _{CC}	Increase in Power Supply Current (Note 5)	3.6		0.2	mA	One Input at V _{CC} - 0.6V Other Inputs at V _{CC} or GND	

Note 3: An external driver must source at least the specified current to switch from LOW-to-HIGH.
Note 4: An external driver must sink at least the specified current to switch from HIGH-to-LOW.
Note 5: This is the increase in supply current for each input that is at the specified voltage level rather than V_{CC} or GND.

Dynamic Switching Characteristics (Note 6)

Symbol	Parameter	V _{CC} (V)	T _A = 25°C			Units	Conditions C _L = 50 pF, R _L = 500Ω
			Min	Typ	Max		
V _{OLP}	Quiet Output Maximum Dynamic V _{OL}	3.3		0.8		V	(Note 7)
V _{OLV}	Quiet Output Minimum Dynamic V _{OL}	3.3		-0.8		V	(Note 7)

Note 6: Characterized in SOIC package. Guaranteed parameter, but not tested.
Note 7: Max number of outputs defined as (n). n-1 data inputs are driven 0V to 3V. Output under test held LOW.

AC Electrical Characteristics						
Symbol	Parameter	$T_A = -40^\circ\text{C to } +85^\circ\text{C}$ $C_L = 50\text{ pF}, R_L = 500\Omega$				Units
		$V_{CC} = 3.3V \pm 0.3V$		$V_{CC} = 2.7V$		
		Min	Max	Min	Max	
t_{PLH}	Propagation Delay	1.3	4.4	1.3	4.8	ns
t_{PHL}	Data to Outputs	1.3	4.6	1.3	5.2	
t_{PLH}	Propagation Delay	1.3	5.4	1.3	6.4	ns
t_{PHL}	\overline{LE} to A or B	1.3	5.8	1.3	6.6	
t_{PZH}	Output Enable Time	1.1	5.5	1.1	6.3	ns
t_{PZL}	\overline{OE} to A or B	1.1	6.1	1.1	7.2	
t_{PHZ}	Output Disable Time	2.0	5.7	2.0	5.9	ns
t_{PLZ}	\overline{OE} to A or B	2.0	5.3	2.0	5.9	
t_{PZH}	Output Enable Time	1.3	5.9	1.3	6.8	ns
t_{PZL}	\overline{CE} to A or B	1.3	6.2	1.3	7.4	
t_{PHZ}	Output Disable Time	2.1	5.8	2.1	6.1	ns
t_{PLZ}	\overline{CE} to A or B	1.6	5.4	1.6	5.9	
t_W	Pulse Duration	\overline{LE} LOW		3.3	3.3	ns
t_S	Setup Time	A or B before \overline{LE} , Data HIGH	0.4	0.4	ns	
		A or B before \overline{LE} , Data LOW	1.0	1.5		
		A or B before \overline{CE} , Data HIGH	0.2	0.2		
		A or B before \overline{CE} , Data LOW	0.7	1.2		
t_H	Hold Time	A or B before \overline{LE} , Data HIGH	1.5	0.6	ns	
		A or B before \overline{LE} , Data LOW	1.3	1.5		
		A or B before \overline{CE} , Data HIGH	1.6	0.5		
		A or B before \overline{CE} , Data LOW	1.4	1.6		
t_{OSHL}	Output to Output Skew (Note 8)		1.0		1.0	ns
t_{OSLH}		1.0		1.0		

Note 8: Skew is defined as the absolute value of the difference between the actual propagation delay for any two separate outputs of the same device. The specification applies to any outputs switching in the same direction, either HIGH-to-LOW (t_{OSHL}) or LOW-to-HIGH (t_{OSLH}).

Capacitance (Note 9)

Symbol	Parameter	Conditions	Typical	Units
C_{IN}	Input Capacitance	$V_{CC} = 0V, V_I = 0V$ or V_{CC}	4	pF
$C_{I/O}$	Input/Output Capacitance	$V_{CC} = 3.0V, V_O = 0V$ or V_{CC}	8	pF

Note 9: Capacitance is measured at frequency $f = 1\text{ MHz}$, per MIL-STD-883B, Method 3012.

74LVTH543

Physical Dimensions inches (millimeters) unless otherwise noted

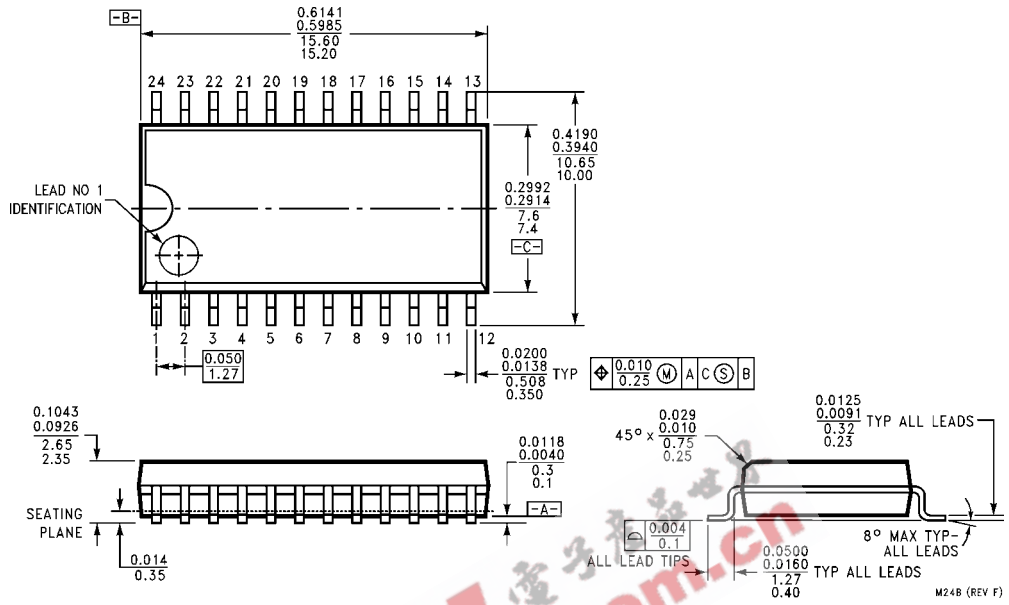

**24-Lead Small Outline Integrated Circuit (SOIC), JEDEC MS-013, 0.300" Wide
Package Number M24B**

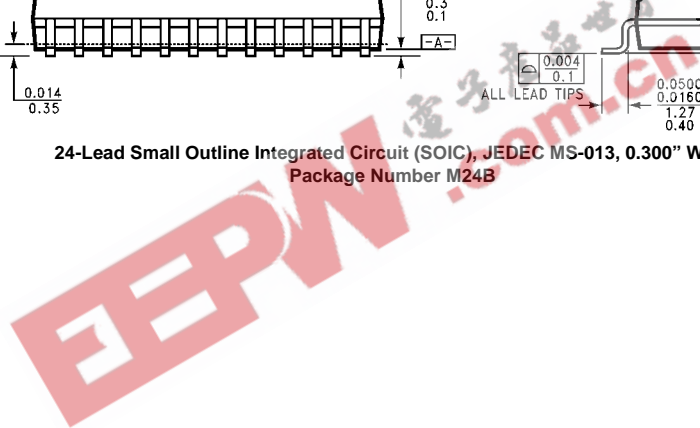

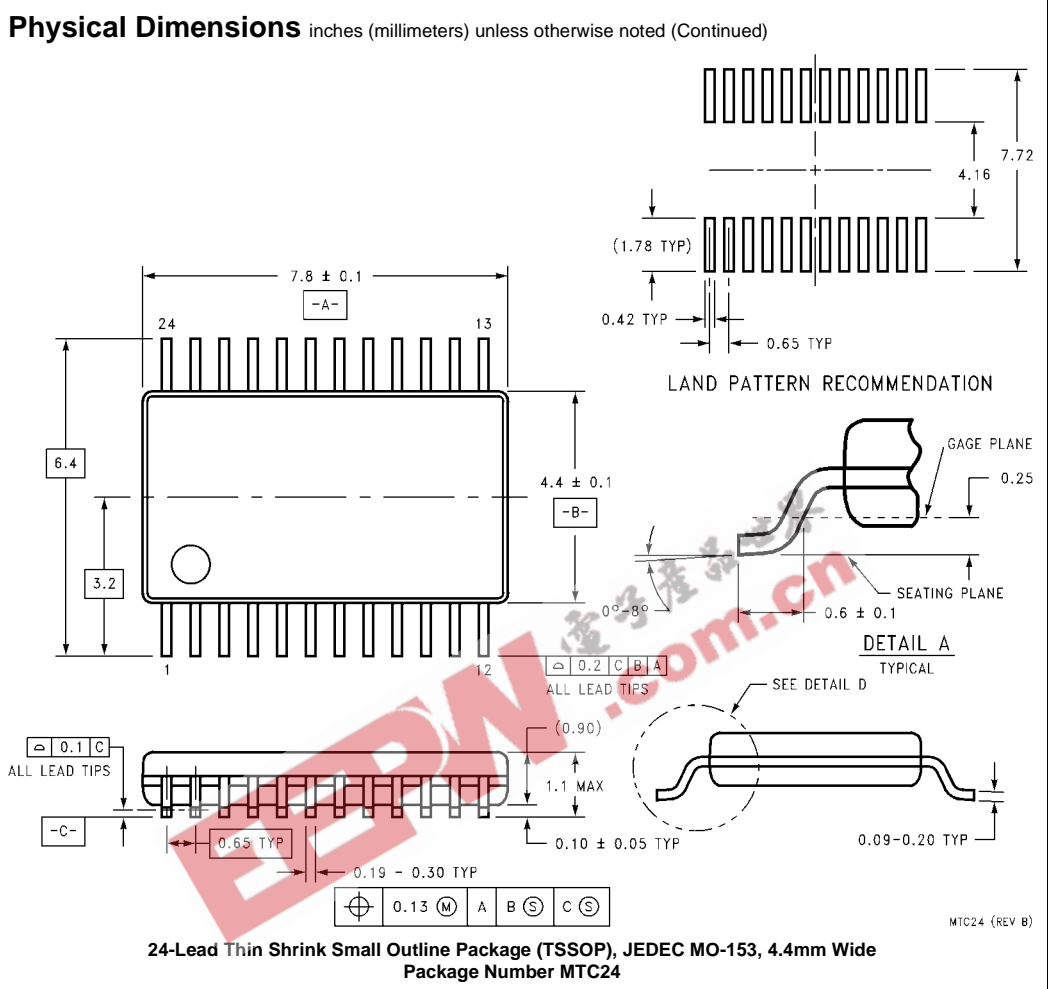

Fairchild does not assume any responsibility for use of any circuitry described, no circuit patent licenses are implied and Fairchild reserves the right at any time without notice to change said circuitry and specifications.

LIFE SUPPORT POLICY

FAIRCHILD'S PRODUCTS ARE NOT AUTHORIZED FOR USE AS CRITICAL COMPONENTS IN LIFE SUPPORT DEVICES OR SYSTEMS WITHOUT THE EXPRESS WRITTEN APPROVAL OF THE PRESIDENT OF FAIRCHILD SEMICONDUCTOR CORPORATION. As used herein:

1. Life support devices or systems are devices or systems which, (a) are intended for surgical implant into the body, or (b) support or sustain life, and (c) whose failure to perform when properly used in accordance with instructions for use provided in the labeling, can be reasonably expected to result in a significant injury to the user.
2. A critical component in any component of a life support device or system whose failure to perform can be reasonably expected to cause the failure of the life support device or system, or to affect its safety or effectiveness.

www.fairchildsemi.com