

## 74ACTQ821

### Quiet Series™ 10-Bit D-Type Flip-Flop with 3-STATE Outputs

#### General Description

The ACTQ821 is a 10-bit D-type flip-flop with non-inverting 3-STATE outputs arranged in a broadside pinout. The ACTQ821 utilizes Fairchild's Quiet Series™ technology to guarantee quiet output switching and improved dynamic threshold performance. FACT Quiet Series™ features GTO™ output control and undershoot corrector in addition to a split ground bus for superior performance.

#### Features

- Guaranteed simultaneous switching noise level and dynamic threshold performance
- Guaranteed pin-to-pin skew AC performance
- Non-inverting 3-STATE outputs for bus interfacing
- 4 kV minimum ESD immunity
- Outputs source/sink 24 mA
- Functionally identical to the AM29821

#### Ordering Code:

Order Number	Package Number	Package Description
74ACTQ821SC	M24B	24-Lead Small Outline Integrated Circuit (SOIC), JEDEC MS-013, 0.300" Wide Body
74ACTQ821SPC	N24C	24-Lead Plastic Dual-In-Line Package (PDIP), JEDEC MS-100, 0.300" Wide

Device also available in Tape and Reel. Specify by appending suffix letter "X" to the ordering code.

#### Logic Symbols

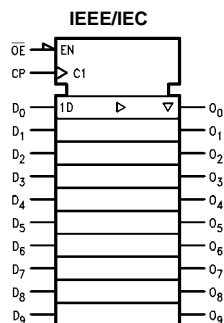
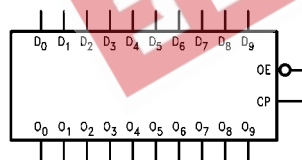

#### Connection Diagram

Pin Assignment for DIP and SOIC

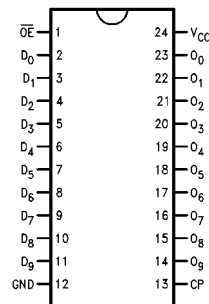

#### Pin Descriptions

Pin Names	Description
D <sub>0</sub> -D <sub>9</sub>	Data Inputs
O <sub>0</sub> -O <sub>9</sub>	Data Outputs
OE	Output Enable Input
CP	Clock Input

## Functional Description

The ACTQ821 consists of ten-bit D-type edge-triggered flip-flops. The buffered Clock (CP) and buffered Output Enable ( $\overline{OE}$ ) are common to all flip-flops. The flip-flops will store the state of their individual D inputs that meet the setup and hold time requirements on the LOW-to-HIGH CP transition. With  $\overline{OE}$  LOW the contents of the flip-flops are available at the outputs. When  $\overline{OE}$  is HIGH the outputs go to the high impedance state. Operation of the  $\overline{OE}$  input does not affect the state of the flip-flops.

The ACTQ821 is functionally and pin compatible with the AM29821.

## Function Table

Inputs			Internal	Outputs	Function
$\overline{OE}$	CP	D	Q	O	
H	↗	L	L	Z	High Z
H	↗	H	H	Z	High Z
L	↗	L	L	L	Load
L	↗	H	H	H	Load

H = HIGH Voltage Level  
 L = LOW Voltage Level  
 Z = HIGH Impedance  
 ↗ = LOW-to-HIGH Clock Transition

## Logic Diagram

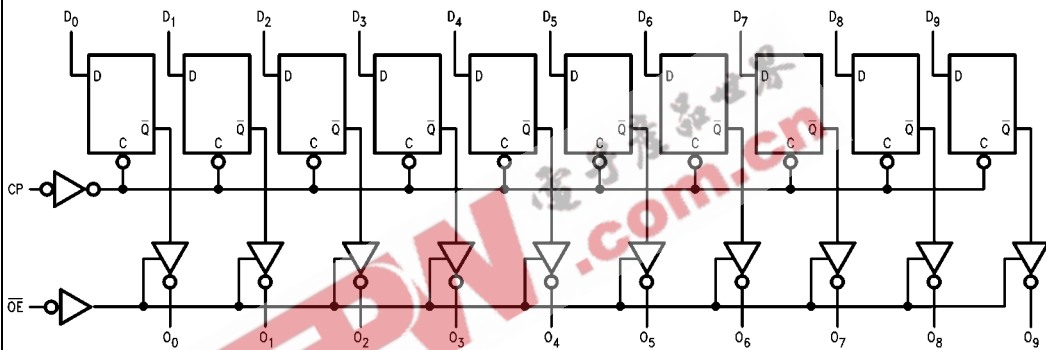

Please note that this diagram is provided only for the understanding of logic operations and should not be used to estimate propagation delays.

Absolute Maximum Ratings (Note 1)		Junction Temperature ( $T_J$ )						
Supply Voltage ( $V_{CC}$ )	- 0.5V to + 7.0V	PDIP	140°C					
DC Input Diode Current ( $I_{IK}$ )		<b>Recommended Operating Conditions</b>						
$V_I = -0.5V$	- 20 mA	Supply Voltage ( $V_{CC}$ )	4.5V to 5.5V					
$V_I = V_{CC} + 0.5V$	+ 20 mA	Input Voltage ( $V_I$ )	0V to $V_{CC}$					
DC Input Voltage ( $V_I$ )	- 0.5V to $V_{CC} + 0.5V$	Output Voltage ( $V_O$ )	0V to $V_{CC}$					
DC Output Diode Current ( $I_{OK}$ )		Operating Temperature ( $T_A$ )	- 40°C to + 85°C					
$V_O = -0.5V$	- 20 mA	Minimum Input Edge Rate $\Delta V/\Delta t$						
$V_O = V_{CC} + 0.5V$	+ 20 mA	Minimum Input Edge Rate $\Delta V/\Delta t$	125 mV/ns					
DC Output Voltage ( $V_O$ )	- 0.5V to $V_{CC} + 0.5V$	$V_{IN}$ from 0.8V to 2.0V						
DC Output Source		$V_{CC}$ @ 4.5V, 5.5V						
or Sink Current ( $I_O$ )	$\pm 50$ mA	<b>Note 1:</b> Absolute maximum ratings are those values beyond which damage to the device may occur. The databook specifications should be met, without exception, to ensure that the system design is reliable over its power supply, temperature, and output/input loading variables. Fairchild does not recommend operation of FACT™ circuits outside databook specifications.						
DC $V_{CC}$ or Ground Current								
per Output Pin ( $I_{CC}$ or $I_{GND}$ )	$\pm 50$ mA							
Storage Temperature ( $T_{STG}$ )	- 65°C to + 150°C							
DC Latch-Up Source								
or Sink Current	$\pm 300$ mA							
<b>DC Electrical Characteristics</b>								
Symbol	Parameter	$V_{CC}$ (V)	$T_A = +25^\circ\text{C}$		$T_A = -40^\circ\text{C to } +85^\circ\text{C}$		Units	Conditions
			Typ	Guaranteed Limits				
$V_{IH}$	Minimum High Level Input Voltage	4.5	1.5	2.0	2.0	V	$V_{OUT} = 0.1V$ or $V_{CC} - 0.1V$	
		5.5	1.5	2.0	2.0			
$V_{IL}$	Maximum Low Level Input Voltage	4.5	1.5	0.8	0.8	V	$V_{OUT} = 0.1V$ or $V_{CC} - 0.1V$	
		5.5	1.5	0.8	0.8			
$V_{OH}$	Minimum High Level Output Voltage	4.5	4.49	4.4	4.4	V	$I_{OUT} = -50 \mu A$	
		5.5	5.49	5.4	5.4			
$V_{OL}$	Maximum Low Level Output Voltage	4.5		3.86	3.76	V	$V_{IN} = V_{IL}$ or $V_{IH}$ $I_{OH} = -24$ mA $I_{OH} = -24$ mA (Note 2)	
		5.5		4.86	4.76			
		4.5	0.001	0.1	0.1	V	$I_{OUT} = 50 \mu A$	
		5.5	0.001	0.1	0.1			
$V_{OL}$	Maximum Low Level Output Voltage	4.5		0.36	0.44	V	$V_{IN} = V_{IL}$ or $V_{IH}$ $I_{OL} = 24$ mA $I_{OL} = 24$ mA (Note 2)	
		5.5		0.36	0.44			
$I_{IN}$	Maximum Input Leakage Current	5.5		$\pm 0.1$	$\pm 1.0$	$\mu A$	$V_I = V_{CC}, GND$	
$I_{OZ}$	Maximum 3-STATE Leakage Current	5.5		$\pm 0.5$	$\pm 5.0$	$\mu A$	$V_I = V_{IL}, V_{IH}$ $V_O = V_{CC}, GND$	
$I_{CCT}$	Maximum $I_{CC}/I_{input}$	5.5	0.6		1.5	mA	$V_I = V_{CC} - 2.1V$	
$I_{OLD}$	Minimum Dynamic Output Current (Note 3)	5.5			75	mA	$V_{OLD} = 1.65V$ Max	
$I_{OHD}$	Maximum Dynamic Output Current (Note 3)	5.5			-75	mA	$V_{OHD} = 3.85V$ Min	
$I_{CC}$	Maximum Quiescent Supply Current	5.5		8.0	80.0	$\mu A$	$V_{IN} = V_{CC}$ or GND	
$V_{OLP}$	Quiet Output Maximum Dynamic $V_{OL}$	5.0	1.1	1.5		V	Figure 1, Figure 2 (Note 4)(Note 5)	
$V_{OLV}$	Quiet Output Minimum Dynamic $V_{OL}$	5.0	-0.6	-1.2		V	Figure 1, Figure 2 (Note 4)(Note 5)	
$V_{IHD}$	Minimum High Level Dynamic Input Voltage	5.0	1.9	2.2		V	(Note 4)(Note 6)	
$V_{ILD}$	Maximum Low Level Dynamic Input Voltage	5.0	1.2	0.8		V	(Note 4)(Note 6)	
<p><b>Note 2:</b> All outputs loaded; thresholds on input associated with output under test.</p> <p><b>Note 3:</b> Maximum test duration 2.0 ms, one output loaded at a time.</p> <p><b>Note 4:</b> DIP package.</p> <p><b>Note 5:</b> Max number of outputs defined as (n). Data inputs are driven 0V to 3V. One output @ GND.</p>								

**DC Electrical Characteristics** (Continued)

**Note 6:** Maximum number of data inputs (n) switching. (n-1) inputs switching 0V to 3V. Input-under-test switching: 3V to threshold ( $V_{ILD}$ ), 0V to threshold ( $V_{IHD}$ ),  $f = 1$  MHz.

**AC Electrical Characteristics**

Symbol	Parameter	V <sub>CC</sub> (V) (Note 7)	T <sub>A</sub> = +25°C C <sub>L</sub> = 50 pF			T <sub>A</sub> = -40°C to +85°C C <sub>L</sub> = 50 pF		Units
			Min	Typ	Max	Min	Max	
f <sub>max</sub>	Maximum Clock Frequency	5.0	120			110		MHz
t <sub>PLH</sub> t <sub>PHL</sub>	Propagation Delay CP to O <sub>n</sub>	5.0	3.0	6.5	9.5	2.5	10.5	ns
t <sub>PZH</sub> t <sub>PZL</sub>	Output Enable Time $\overline{OE}$ to O <sub>n</sub>	5.0	3.0	7.5	10.5	2.5	11.5	ns
t <sub>PHZ</sub> t <sub>PLZ</sub>	Output Disable Time $\overline{OE}$ to O <sub>n</sub>	5.0	1.0	6.5	8.5	1.0	9.0	ns
t <sub>OSLH</sub> t <sub>OSSL</sub>	Output to Output Skew CP to O <sub>n</sub> (Note 8)	5.0		0.5	1.0		1.0	ns

**Note 7:** Voltage Range 5.0 is 5.0V ± 0.5V

**Note 8:** Skew is defined as the absolute value of the difference between the actual propagation delay for any two outputs within the same packaged device. The specification applies to any outputs switching in the same direction, either HIGH to LOW (t<sub>OSSL</sub>) or LOW to HIGH (t<sub>OSLH</sub>). Parameter guaranteed by design. Not tested.

**AC Operating Requirements**

Symbol	Parameter	V <sub>CC</sub> (V) (Note 9)	T <sub>A</sub> = +25°C C <sub>L</sub> = 50 pF	T <sub>A</sub> = -40°C to +85°C C <sub>L</sub> = 50 pF		Units
			Typ	Guaranteed Minimum		
t <sub>S</sub>	Setup Time, HIGH or LOW D <sub>n</sub> to CP	5.0		3.0	3.0	ns
t <sub>H</sub>	Hold Time, HIGH or LOW D <sub>n</sub> to CP	5.0		1.5	1.5	ns
t <sub>H</sub>	CP Pulse Width HIGH or LOW	5.0		4.5	5.5	ns

**Note 9:** Voltage Range 5.0 is 5.0V ± 0.5V

**Capacitance**

Symbol	Parameter	Typ	Units	Conditions
C <sub>IN</sub>	Input Capacitance	4.5	pF	V <sub>CC</sub> = OPEN
C <sub>PD</sub>	Power Dissipation Capacitance	55.0	pF	V <sub>CC</sub> = 5.0V

## FACT Noise Characteristics

The setup of a noise characteristics measurement is critical to the accuracy and repeatability of the tests. The following is a brief description of the setup used to measure the noise characteristics of FACT.

### Equipment:

Hewlett Packard Model 8180A Word Generator  
PC-163A Test Fixture  
Tektronics Model 7854 Oscilloscope

### Procedure:

1. Verify Test Fixture Loading: Standard Load 50 pF, 500Ω.
2. Deskew the HFS generator so that no two channels have greater than 150 ps skew between them. This requires that the oscilloscope be deskewed first. It is important to deskew the HFS generator channels before testing. This will ensure that the outputs switch simultaneously.
3. Terminate all inputs and outputs to ensure proper loading of the outputs and that the input levels are at the correct voltage.
4. Set the HFS generator to toggle all but one output at a frequency of 1 MHz. Greater frequencies will increase DUT heating and effect the results of the measurement.
5. Set the HFS generator input levels at 0V LOW and 3V HIGH for ACT devices and 0V LOW and 5V HIGH for AC devices. Verify levels with an oscilloscope.

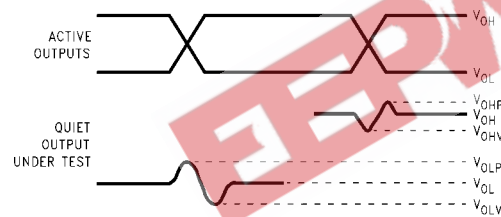

**Note 10:**  $V_{OHV}$  and  $V_{OLP}$  are measured with respect to ground reference.

**Note 11:** Input pulses have the following characteristics:  $f = 1$  MHz,  $t_r = 3$  ns,  $t_f = 3$  ns, skew < 150 ps.

**FIGURE 1. Quiet Output Noise Voltage Waveforms**

$V_{OLP}/V_{OLV}$  and  $V_{OHP}/V_{OHV}$ :

- Determine the quiet output pin that demonstrates the greatest noise levels. The worst case pin will usually be the furthest from the ground pin. Monitor the output voltages using a 50Ω coaxial cable plugged into a standard SMB type connector on the test fixture. Do not use an active FET probe.
- Measure  $V_{OLP}$  and  $V_{OLV}$  on the quiet output during the worst case transition for active and enable. Measure  $V_{OHP}$  and  $V_{OHV}$  on the quiet output during the worst case active and enable transition.
- Verify that the GND reference recorded on the oscilloscope has not drifted to ensure the accuracy and repeatability of the measurements.

$V_{ILD}$  and  $V_{IHD}$ :

- Monitor one of the switching outputs using a 50Ω coaxial cable plugged into a standard SMB type connector on the test fixture. Do not use an active FET probe.
- First increase the input LOW voltage level,  $V_{IL}$ , until the output begins to oscillate or steps out a min of 2 ns. Oscillation is defined as noise on the output LOW level that exceeds  $V_{IL}$  limits, or on output HIGH levels that exceed  $V_{IH}$  limits. The input LOW voltage level at which oscillation occurs is defined as  $V_{ILD}$ .
- Next decrease the input HIGH voltage level  $V_{IH}$  until the output begins to oscillate or steps out a min of 2ns. Oscillation is defined as noise on the output LOW level that exceeds  $V_{IL}$  limits, or on output HIGH levels that exceed  $V_{IH}$  limits. The input HIGH voltage level at which oscillation occurs is defined as  $V_{IHD}$ .
- Verify that the GND reference recorded on the oscilloscope has not drifted to ensure the accuracy and repeatability of the measurements.

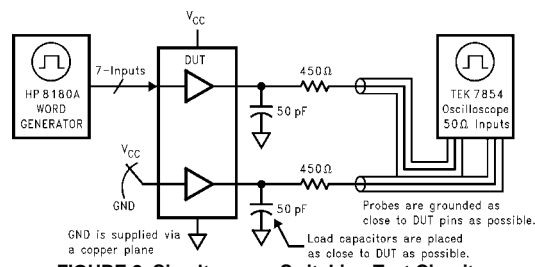

**FIGURE 2. Simultaneous Switching Test Circuit**



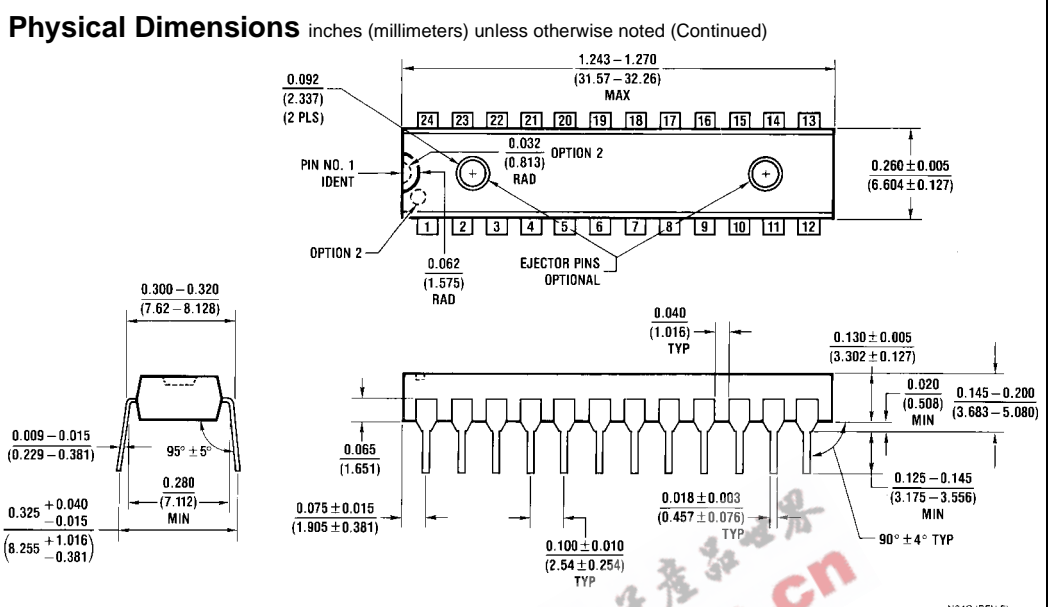

24-Lead Plastic Dual-In-Line Package (PDIP), JEDEC MS-100, 0.300" Wide  
 Package Number N24C

N24C (REV F)

**LIFE SUPPORT POLICY**

FAIRCHILD'S PRODUCTS ARE NOT AUTHORIZED FOR USE AS CRITICAL COMPONENTS IN LIFE SUPPORT DEVICES OR SYSTEMS WITHOUT THE EXPRESS WRITTEN APPROVAL OF THE PRESIDENT OF FAIRCHILD SEMICONDUCTOR CORPORATION. As used herein:

1. Life support devices or systems are devices or systems which, (a) are intended for surgical implant into the body, or (b) support or sustain life, and (c) whose failure to perform when properly used in accordance with instructions for use provided in the labeling, can be reasonably expected to result in a significant injury to the user.
2. A critical component in any component of a life support device or system whose failure to perform can be reasonably expected to cause the failure of the life support device or system, or to affect its safety or effectiveness.

[www.fairchildsemi.com](http://www.fairchildsemi.com)

Fairchild does not assume any responsibility for use of any circuitry described, no circuit patent licenses are implied and Fairchild reserves the right at any time without notice to change said circuitry and specifications.