

74ABT16500 18-Bit Universal Bus Transceivers with 3-STATE Outputs

General Description

The ABT16500 18-bit universal bus transceiver combines D-type latches and D-type flip-flops to allow data flow in transparent, latched, and clocked modes.

Data flow in each direction is controlled by output-enable (OEAB and OEBA), latch-enable (LEAB and LEBA), and clock (CLKAB and CLKBA) inputs. For A-to-B data flow, the device operates in the transparent mode when LEAB is HIGH. When LEAB is LOW, the A data is latched if CLKAB is held at a HIGH or LOW logic level. If LEAB is LOW, the A bus data is stored in the latch/flip-flop on the HIGH-to-LOW transition of CLKAB. Output-enable OEAB is active-high. When OEAB is HIGH, the outputs are active. When OEAB is LOW, the outputs are in the high-impedance state.

Data flow for B to A is similar to that of A to B but uses OEBA, LEBA, and CLKBA. The output enables are com-

plementary (OEAB is active HIGH and OEBA is active LOW).

To ensure the high-impedance state during power up or power down, OE should be tied to GND through a pull-down resistor; the minimum value of the resistor is determined by the current-sourcing capability of the driver.

Features

- Combines D-Type latches and D-Type flip-flops for operation in transparent, latched, or clocked mode
- Flow-through architecture optimizes PCB layout
- Guaranteed latch-up protection
- High impedance glitch free bus loading during entire power up and power down cycle
- Non-destructive hot insertion capability

Ordering Code:

Order Number	Package Number	Package Description
74ABT16500CSSC	MS56A	56-Lead Shrink Small Outline Package (SSOP), JEDEC MO-118, 0.300" Wide
74ABT16500CMTD	MTD56	56-Lead Thin Shrink Small Outline Package (TSSOP), JEDEC MO-153, 6.1mm Wide

Devices also available in Tape and Reel. Specify by appending the letter suffix "X" to the ordering code.

Connection Diagram

Pin Assignment for SSOP

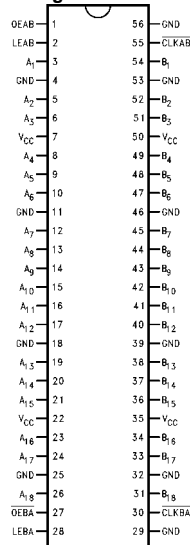

Function Table (Note 1)

Inputs				Output
OEAB	LEAB	CLKAB	A	B
L	X	X	X	Z
H	H	X	L	L
H	H	X	H	H
H	L	↓	L	L
H	L	↓	H	H
H	L	H	X	B ₀ (Note 2)
H	L	L	X	B ₀ (Note 3)

Note 1: A-to-B data flow is shown; B-to-A flow is similar but uses OEBA, LEBA, and CLKBA.

Note 2: Output level before the indicated steady-state input conditions were established.

Note 3: Output level before the indicated steady-state input conditions were established, provided that CLKAB was LOW before LEAB went LOW.

74ABT16500

Logic Diagram

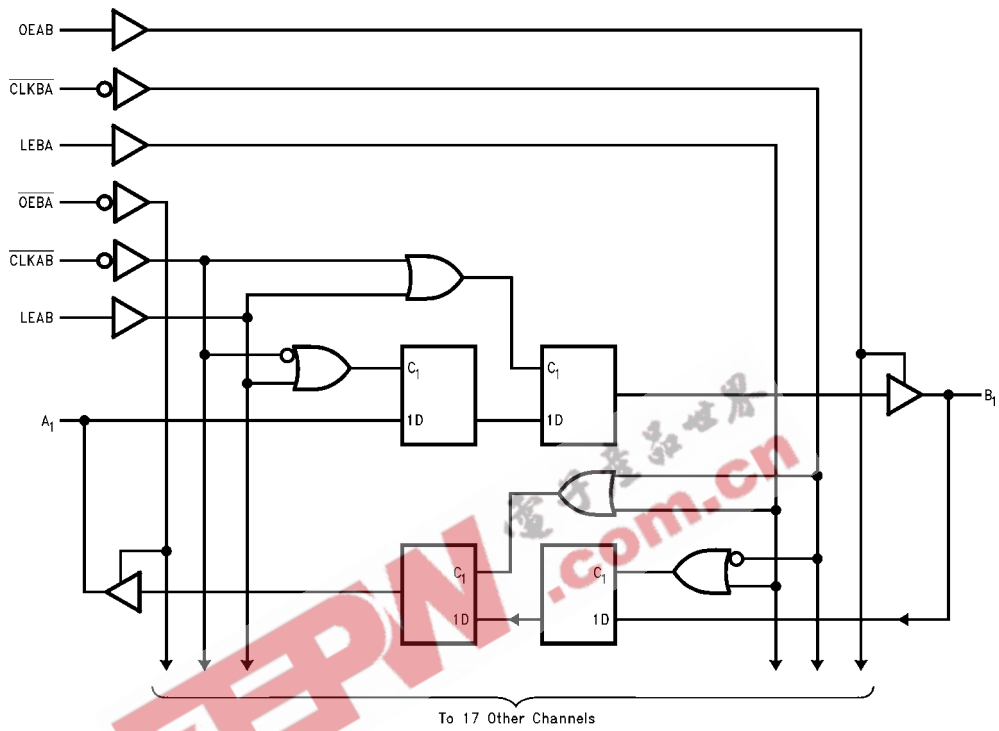

Absolute Maximum Ratings (Note 4)		DC Latchup Source Current	-500 mA
Storage Temperature	-65°C to +150°C	Over Voltage Latchup (I/O)	10V
Ambient Temperature under Bias	-55°C to +125°C	Recommended Operating Conditions	
Junction Temperature under Bias	-55°C to +150°C	Free Air Ambient Temperature	-40°C to +85°C
V _{CC} Pin Potential to Ground Pin	-0.5V to +7.0V	Supply Voltage	+4.5V to +5.5V
Input Voltage (Note 5)	-0.5V to +7.0V	Minimum Input Edge Rate ($\Delta V/\Delta t$)	
Input Current (Note 5)	-30 mA to +5.0 mA	Data Input	50 mV/ns
Voltage Applied to Any Output in the Disabled or Power-off State	-0.5V to 5.5V	Enable Input	20 mV/ns
in the HIGH State	-0.5V to V _{CC}	Note 4: Absolute maximum ratings are values beyond which the device may be damaged or have its useful life impaired. Functional operation under these conditions is not implied.	
Current Applied to Output in LOW State (Max)	twice the rated I _{OL} (mA)	Note 5: Either voltage limit or current limit is sufficient to protect inputs.	

DC Electrical Characteristics

Symbol	Parameter	Min	Typ	Max	Units	V _{CC}	Conditions
V _{IH}	Input HIGH Voltage	2.0			V		Recognized HIGH Signal
V _{IL}	Input LOW Voltage			0.8	V		Recognized LOW Signal
V _{CD}	Input Clamp Diode Voltage			-1.2	V	Min	I _{IN} = -18 mA
V _{OH}	Output HIGH Voltage	2.5			V	Min	I _{OH} = -3 mA
		2.0			V	Min	I _{OH} = -32 mA
V _{OL}	Output LOW Voltage			0.55	V	Min	I _{OL} = 64 mA
I _{IH}	Input HIGH Current			1	μA	Max	V _{IN} = 2.7V (Note 6)
				1	μA	Max	V _{IN} = V _{CC}
I _{BV1}	Input HIGH Current Breakdown Test			7	μA	Max	V _{IN} = 7.0V
I _{IL}	Input LOW Current			-1	μA	Max	V _{IN} = 0.5V (Note 6)
				-1	μA	Max	V _{IN} = 0.0V
V _{ID}	Input Leakage Test	4.75			V	0.0	I _{ID} = 1.9 μA All Other Pins Grounded
I _{IH} + I _{OZH}	Output Leakage Current			10	μA	0 - 5.5V	V _{OUT} = 2.7V; \overline{OE} , OE = 2.0V
				-10	μA	0 - 5.5V	V _{OUT} = 0.5V; \overline{OE} , OE = 2.0V
I _{IL} + I _{OZL}	Output Leakage Current				μA	0 - 5.5V	V _{OUT} = 0.5V; \overline{OE} , OE = 2.0V
I _{OS}	Output Short-Circuit Current	-100		-275	mA	Max	V _{OUT} = 0V
I _{CEX}	Output HIGH Leakage Current			50	μA	Max	V _{OUT} = V _{CC}
I _{ZZ}	Bus Drainage Test			100	μA	0.0	V _{OUT} = 5.5V; All Others GND
I _{CCH}	Power Supply Current			1.0	mA	Max	All Outputs HIGH
I _{CCL}	Power Supply Current			68	μA	Max	A _n or B _n Outputs Low
I _{CCZ}	Power Supply Current			1.0	mA	Max	$\overline{OE}_1 = V_{CC}$, All Others at V _{CC} or GND
I _{CC1}	Additional I _{CC} /Input			2.5	mA	Max	V _I = V _{CC} - 2.1V All Others at V _{CC} or GND
I _{CCD}	Dynamic I _{CC} (Note 6)	No Load		0.23	mA/ MHz	Max	Outputs Open Transparent Mode One Bit Toggling, 50% Duty Cycle

Note 6: Guaranteed, but not tested.

DC Electrical Characteristics

Symbol	Parameter	Min	Typ	Max	Units	V _{CC}	Conditions
							C _L = 50 pF; R _L = 500Ω
V _{OLP}	Quiet Output Maximum Dynamic V _{OL}		0.7	1.2	V	5.0	T _A = 25°C (Note 7)
V _{OLV}	Quiet Output Minimum Dynamic V _{OL}	-1.5	-1.0		V	5.0	T _A = 25°C (Note 7)
V _{OHV}	Minimum HIGH Level Dynamic Output Voltage	2.5	3.0		V	5.0	T _A = 25°C (Note 8)
V _{IHD}	Minimum HIGH Level Dynamic Input Voltage	2.2	1.8		V	5.0	T _A = 25°C (Note 9)
V _{ILD}	Maximum LOW Level Dynamic Input Voltage		1.2	0.8	V	5.0	T _A = 25°C (Note 9)

Note 7: Max number of outputs defined as (n). n – 1 data inputs are driven 0V to 3V. One output at LOW. Guaranteed, but not tested.

Note 8: Max number of outputs defined as (n). n – 1 data inputs are driven 0V to 3V. One output HIGH. Guaranteed, but not tested.

Note 9: Max number of data inputs (n) switching. n – 1 inputs switching 0V to 3V. Input-under-test switching: 3V to threshold (V_{ILD}), 0V to threshold (V_{IHD}). Guaranteed, but not tested.

AC Electrical Characteristics

Symbol	Parameter	T _A = +25°C V _{CC} = +5V C _L = 50 pF			T _A = -40°C to +85°C V _{CC} = 4.5V–5.5V C _L = 50 pF		Units
		Min	Typ	Max	Min	Max	
		f _{max}	Maximum Clock Frequency	150	200		
t _{PLH}	Propagation Delay	1.5	2.7	4.6	1.5	4.6	ns
t _{PHL}	A or B to B or A	1.5	3.2	4.6	1.5	4.6	
t _{PLH}	Propagation Delay	1.5	3.1	5.0	1.5	5.0	ns
t _{PHL}	LEAB or LEBA to B or A	1.5	3.6	5.0	1.5	5.0	
t _{PLH}	Propagation Delay	1.5	3.4	5.3	1.5	5.3	ns
t _{PHL}	CLKAB or CLKBA to B or A	1.5	3.7	5.3	1.5	5.3	
t _{PZH}	Propagation Delay	1.5	2.7	5.6	1.5	5.6	ns
t _{PZL}	OEAB or OEBA to B or A	1.5	3.0	5.6	1.5	5.6	
t _{PHZ}	Propagation Delay	1.5	3.7	6.0	1.5	6.0	ns
t _{PLZ}	OEAB or OEBA to B or A	1.5	3.2	6.0	1.5	6.0	

AC Operating Requirements									
Symbol	Parameter	$T_A = +25^\circ\text{C}$ $V_{CC} = +5\text{V}$ $C_L = 50\text{ pF}$		$T_A = -40^\circ\text{C to } +85^\circ\text{C}$ $V_{CC} = 4.5\text{V} - 5.5\text{V}$ $C_L = 50\text{ pF}$		Units			
		Min	Max	Min	Max				
$t_{S(H)}$ $t_{S(L)}$	Setup Time, A to $\overline{\text{CLKAB}}$	4.5		4.5			ns		
$t_{H(H)}$ $t_{H(L)}$	Hold Time, A to $\overline{\text{CLKAB}}$	0		0			ns		
$t_{S(H)}$ $t_{S(L)}$	Setup Time, B to $\overline{\text{CLKBA}}$	4.0		4.0			ns		
$t_{H(H)}$ $t_{H(L)}$	Hold Time, B to $\overline{\text{CLKBA}}$	0		0			ns		
$t_{S(H)}$ $t_{S(L)}$	Setup Time, A to LEAB or B to LEBA, $\overline{\text{CLK}}$ HIGH	1.5		1.5			ns		
$t_{H(H)}$ $t_{H(L)}$	Hold Time, A to LEAB or B to LEBA, $\overline{\text{CLK}}$ HIGH	1.5		1.5			ns		
$t_{S(H)}$ $t_{S(L)}$	Setup Time, A to LEAB or B to LEBA, $\overline{\text{CLK}}$ LOW	4.5		4.5			ns		
$t_{H(H)}$ $t_{H(L)}$	Hold Time, A to LEAB or B to LEBA, $\overline{\text{CLK}}$ LOW	1.5		1.5			ns		
$t_{W(H)}$ $t_{W(L)}$	Pulse Width, LEAB or LEBA, HIGH	3.3		3.3			ns		
$t_{W(H)}$ $t_{W(L)}$	Pulse Width, $\overline{\text{CLKAB}}$ or $\overline{\text{CLKBA}}$, HIGH or LOW	3.3		3.3			ns		
Extended AC Electrical Characteristics									
Symbol	Parameter	$T_A = -40^\circ\text{C to } +85^\circ\text{C}$ $V_{CC} = 4.5\text{V} - 5.5\text{V}$ $C_L = 50\text{ pF}$ 18 Outputs Switching (Note 10)			$T_A = -40^\circ\text{C to } +85^\circ\text{C}$ $V_{CC} = 4.5\text{V} - 5.5\text{V}$ $C_L = 250\text{ pF}$ 1 Output Switching (Note 11)		$T_A = -40^\circ\text{C to } +85^\circ\text{C}$ $V_{CC} = 4.5\text{V} - 5.5\text{V}$ $C_L = 250\text{ pF}$ 18 Outputs Switching (Note 12)		Units
		Min	Typ	Max	Min	Max	Min	Max	
t_{PLH} t_{PHL}	Propagation Delay Data to Outputs	1.5		6.5	2.0	7.0	2.5	9.9	ns
t_{PLH} t_{PHL}	Propagation Delay LEAB or LEBA to B or A	1.5		6.0	2.0	7.5	2.5	8.5	ns
t_{PLH} t_{PHL}	Propagation Delay $\overline{\text{CLKAB}}$ or $\overline{\text{CLKBA}}$ to B or A	1.5		6.2	2.0	7.7	2.5	8.5	ns
t_{PZH} t_{PZL}	Output Enable Time	1.5		6.5	2.0	7.0	2.5	8.5	ns
t_{PHZ} t_{PLZ}	Output Disable Time	1.5		6.5	(Note 13)		(Note 13)		ns
<p>Note 10: This specification is guaranteed but not tested. The limits apply to propagation delays for all paths described switching in phase (i.e., all LOW-to-HIGH, HIGH-to-LOW, etc.).</p> <p>Note 11: This specification is guaranteed but not tested. The limits represent propagation delay with 250 pF load capacitors in place of the 50 pF load capacitors in the standard AC load. This specification pertains to single output switching only.</p> <p>Note 12: This specification is guaranteed but not tested. The limits represent propagation delays for all paths described switching in phase (i.e., all LOW-to-HIGH, HIGH-to-LOW, etc.) with 250 pF load capacitors in place of the 50 pF load capacitors in the standard AC load.</p> <p>Note 13: 3-STATE delays are dominated by the RC network (500Ω, 250 pF) on the output and have been excluded from the datasheet.</p>									

Skew				
Symbol	Parameter	$T_A = -40^\circ\text{C to } +85^\circ\text{C}$ $V_{CC} = 4.5\text{V} - 5.5\text{V}$ $C_L = 50\text{ pF}$ 18 Outputs Switching (Note 14)	$T_A = -40^\circ\text{C to } +85^\circ\text{C}$ $V_{CC} = 4.5\text{V} - 5.5\text{V}$ $C_L = 250\text{ pF}$ 18 Outputs Switching (Note 15)	Units
		Max	Max	
t_{OSHL} (Note 16)	Pin to Pin Skew HL Transitions	2.0	2.8	ns
t_{OSLH} (Note 16)	Pin to Pin Skew LH Transitions	2.0	2.5	ns
t_{PS} (Note 17)	Duty Cycle LH-HL Skew	2.0	2.8	ns
t_{OST} (Note 16)	Pin to Pin Skew LH/HL Transitions	2.5	3.0	ns
t_{PV} (Note 18)	Device to Device Skew LH/HL Transitions	3.0	3.5	ns
<p>Note 14: This specification is guaranteed but not tested. The limits apply to propagation delays for all paths described switching in phase (i.e., all LOW-to-HIGH, HIGH-to-LOW, etc.)</p> <p>Note 15: These specifications guaranteed but not tested. The limits represent propagation delays with 250 pF load capacitors in place of the 50 pF load capacitors in the standard AC load.</p> <p>Note 16: Skew is defined as the absolute value of the difference between the actual propagation delays for any two separate outputs of the same device. The specification applies to any outputs switching HIGH-to-LOW (t_{OSHL}), LOW-to-HIGH (t_{OSLH}), or any combination switching LOW-to-HIGH and/or HIGH-to-LOW (t_{OST}). The specification is guaranteed but not tested.</p> <p>Note 17: This describes the difference between the delay of the LOW-to-HIGH and the HIGH-to-LOW transition on the same pin. It is measured across all the outputs (drivers) on the same chip, the worst (largest delta) number is the guaranteed specification. This specification is guaranteed but not tested.</p> <p>Note 18: Propagation delay variation for a given set of conditions (i.e., temperature and V_{CC}) from device to device. This specification is guaranteed but not tested.</p>				
Capacitance				
Symbol	Parameter	Typ	Units	Conditions $T_A = 25^\circ\text{C}$
C_{IN}	Input Capacitance	5.0	pF	$V_{CC} = 0.0\text{V}$
$C_{I/O}$ (Note 19)	Output Capacitance	11.0	pF	$V_{CC} = 5.0\text{V}$
<p>Note 19: $C_{I/O}$ is measured at frequency $f = 1\text{ MHz}$ per MIL-STD-883, Method 3012.</p>				

AC Loading

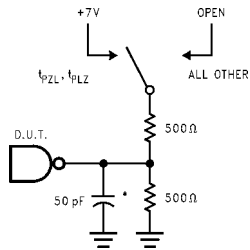

*Includes jig and probe capacitance.

FIGURE 1. Standard AC Test Load

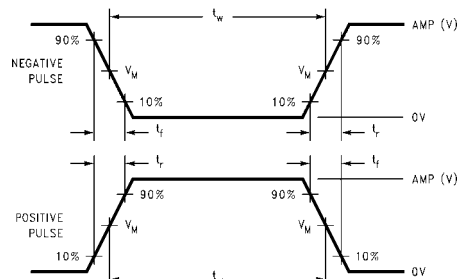

FIGURE 2. $V_M = 1.5V$

Input Pulse Requirements

Amplitude	Rep. Rate	t_w	t_r	t_f
3.0V	1 MHz	500 ns	2.5 ns	2.5 ns

FIGURE 3. Test Input Signal Requirements

AC Waveforms

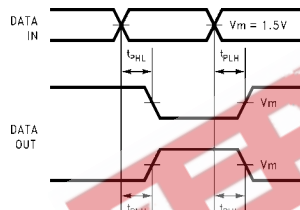

FIGURE 4. Propagation Delay Waveforms for Inverting and Non-Inverting Functions

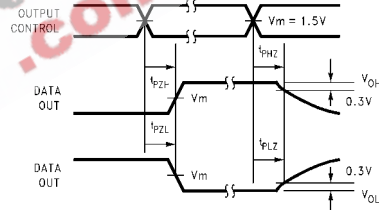

FIGURE 6. 3-STATE Output HIGH and LOW Enable and Disable Times

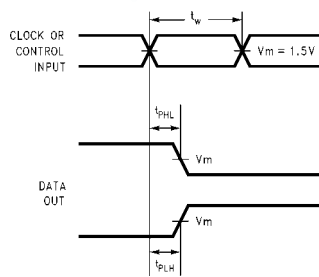

FIGURE 5. Propagation Delay, Pulse Width Waveforms

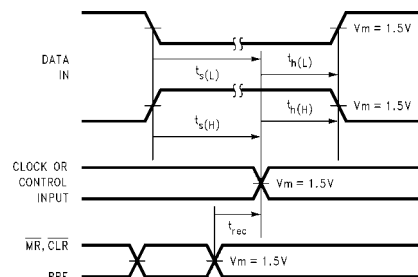
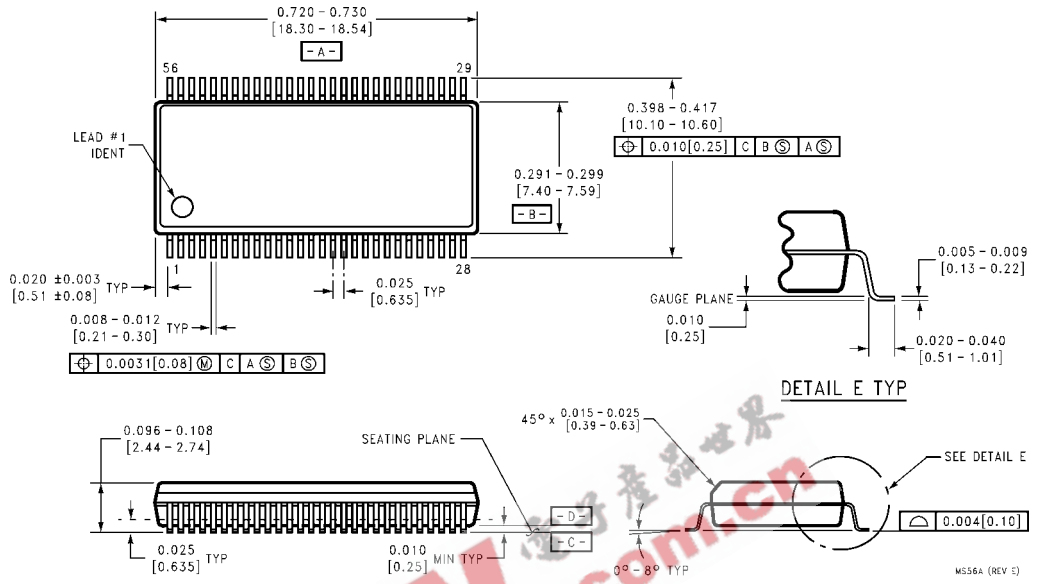

FIGURE 7. Setup Time, Hold Time and Recovery Time Waveforms

74ABT16500

Physical Dimensions inches (millimeters) unless otherwise noted



**56-Lead Shrink Small Outline Package (SSOP), JEDEC MO-118, 0.300" Wide
Package Number MS56A**

Physical Dimensions inches (millimeters) unless otherwise noted (Continued)

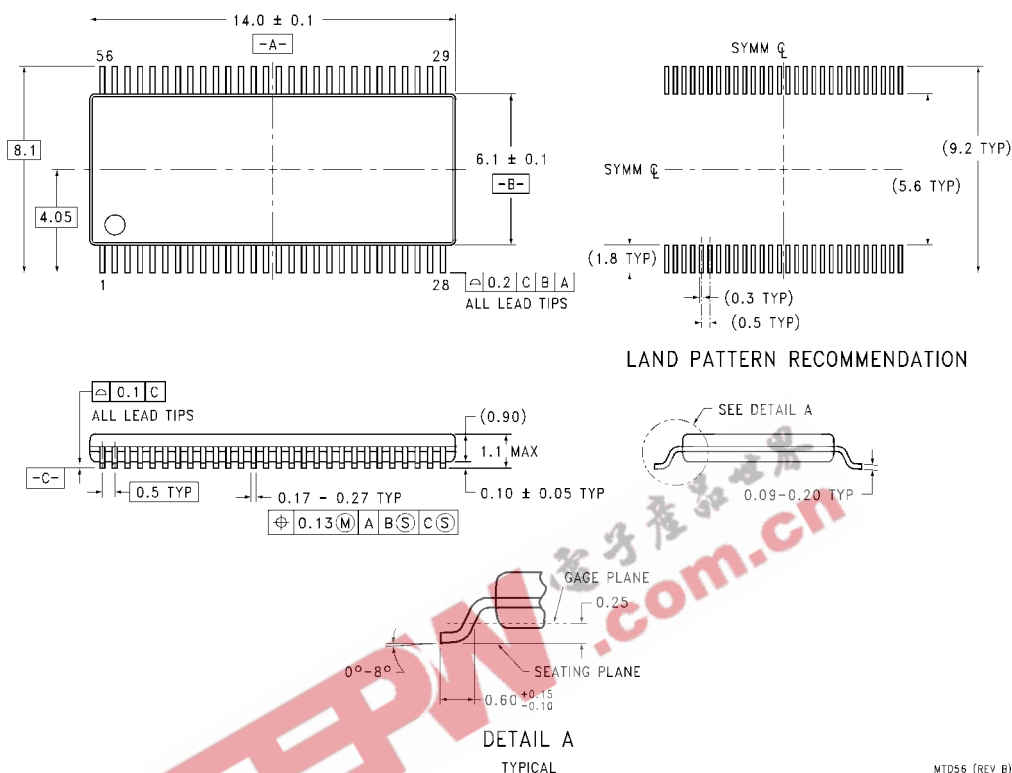

56-Lead Thin Shrink Small Outline Package (TSSOP), JEDEC MO-153, 6.1mm Wide
Package Number MTD56

LIFE SUPPORT POLICY

FAIRCHILD'S PRODUCTS ARE NOT AUTHORIZED FOR USE AS CRITICAL COMPONENTS IN LIFE SUPPORT DEVICES OR SYSTEMS WITHOUT THE EXPRESS WRITTEN APPROVAL OF THE PRESIDENT OF FAIRCHILD SEMICONDUCTOR CORPORATION. As used herein:

1. Life support devices or systems are devices or systems which, (a) are intended for surgical implant into the body, or (b) support or sustain life, and (c) whose failure to perform when properly used in accordance with instructions for use provided in the labeling, can be reasonably expected to result in a significant injury to the user.
2. A critical component in any component of a life support device or system whose failure to perform can be reasonably expected to cause the failure of the life support device or system, or to affect its safety or effectiveness.

www.fairchildsemi.com