

74VCX162374

Low Voltage 16-Bit D-Type Flip-Flop with 3.6V Tolerant Inputs and Outputs and 26Ω Series Resistors in Outputs

General Description

The VCX162374 contains sixteen non-inverting D-type flip-flops with 3-STATE outputs and is intended for bus oriented applications. The device is byte controlled. A buffered clock (CP) and output enable (\overline{OE}) are common to each byte and can be shorted together for full 16-bit operation.

The VCX162374 is also designed with 26Ω series resistors in the outputs. This design reduces line noise in applications such as memory address drivers, clock drivers and bus transceivers/transmitters.

The 74VCX162374 is designed for low voltage (1.4V to 3.6V) V_{CC} applications with I/O compatibility up to 3.6V.

The 74VCX162374 is fabricated with an advanced CMOS technology to achieve high speed operation while maintaining low CMOS power dissipation.

Features

- 1.4V–3.6V V_{CC} supply operation
- 3.6V tolerant inputs and outputs
- 26Ω series resistors in outputs
- t_{PD} (CLK to O_n)
3.4 ns max for 3.0V to 3.6V V_{CC}
- Power-off high impedance inputs and outputs
- Supports live insertion and withdrawal (Note 1)
- Static Drive (I_{OH}/I_{OL})
±12 mA @ 3.0V V_{CC}
- Uses patented noise/EMI reduction circuitry
- Latch-up performance exceeds 300 mA
- ESD performance:
Human body model > 2000V
Machine model > 200V

Note 1: To ensure the high-impedance state during power up or power down, \overline{OE} should be tied to V_{CC} through a pull-up resistor; the minimum value of the resistor is determined by the current-sourcing capability of the driver.

Ordering Code:

Order Number	Package Number	Package Descriptions
74VCX162374MTD	MTD48	48-Lead Thin Shrink Small Outline Package (TSSOP), JEDEC MO-153, 6.1mm Wide

Devices also available in Tape and Reel. Specify by appending suffix letter "X" to the ordering code.

Logic Symbol

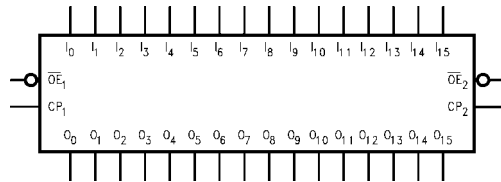

Pin Descriptions

Pin Names	Description
\overline{OE}_n	Output Enable Input (Active LOW)
CP_n	Clock Pulse Input
I_0 – I_{15}	Inputs
O_0 – O_{15}	Outputs

Connection Diagram

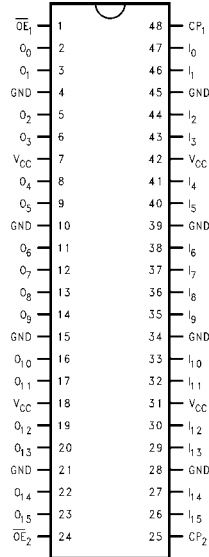

Truth Tables

Inputs			Outputs
CP ₁	\overline{OE}_1	I ₀ -I ₇	O ₀ -O ₇
—	L	H	H
—	L	L	L
L	L	X	O ₀
X	H	X	Z

Inputs			Outputs
CP ₂	\overline{OE}_2	I ₈ -I ₁₅	O ₈ -O ₁₅
—	L	H	H
—	L	L	L
L	L	X	O ₀
X	H	X	Z

H = HIGH Voltage Level
 L = LOW Voltage Level
 X = Immaterial (HIGH or LOW, inputs may not float)
 Z = High Impedance
 O₀ = Previous O₀ before HIGH-to-LOW of CP

Functional Description

The 74VCX162374 consists of sixteen edge-triggered flip-flops with individual D-type inputs and 3-STATE true outputs. The device is byte controlled with each byte functioning identically, but independent of the other. The control pins can be shorted together to obtain full 16-bit operation. Each clock has a buffered clock and buffered Output Enable common to all flip-flops within that byte. The description which follows applies to each byte. Each flip-

flop will store the state of their individual I inputs that meet the setup and hold time requirements on the LOW-to-HIGH Clock (CP_n) transition. With the Output Enable (\overline{OE}_n) LOW, the contents of the flip-flops are available at the outputs. When \overline{OE}_n is HIGH, the outputs go to the high impedance state. Operations of the \overline{OE}_n input does not affect the state of the flip-flops.

Logic Diagram

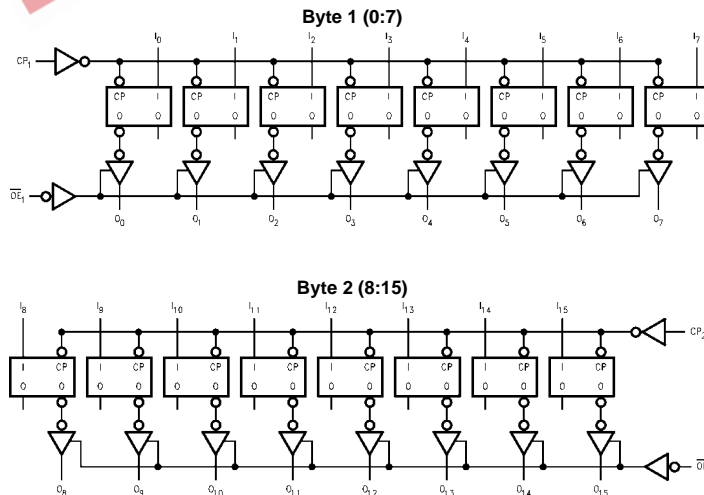

Please note that this diagram is provided only for the understanding of logic operations and should not be used to estimate propagation delays.

Absolute Maximum Ratings (Note 2)

Supply Voltage (V_{CC})	-0.5V to +4.6V
DC Input Voltage (V_I)	-0.5V to +4.6V
Output Voltage (V_O)	
Outputs 3-STATED	-0.5V to +4.6V
Outputs Active (Note 3)	-0.5V to $V_{CC} + 0.5V$
DC Input Diode Current (I_{IK}) $V_I < 0V$	-50 mA
DC Output Diode Current (I_{OK})	
$V_O < 0V$	-50 mA
$V_O > V_{CC}$	+50 mA
DC Output Source/Sink Current (I_{OH}/I_{OL})	± 50 mA
DC V_{CC} or GND Current per Supply Pin (I_{CC} or GND)	± 100 mA
Storage Temperature Range (T_{STG})	-65°C to +150°C

Recommended Operating Conditions (Note 4)

Power Supply	
Operating	1.4V to 3.6V
Input Voltage	-0.3V to +3.6V
Output Voltage (V_O)	
Output in Active States	0V to V_{CC}
Output in "OFF" State	0.0V to 3.6V
Output Current in I_{OH}/I_{OL}	
$V_{CC} = 3.0V$ to 3.6V	± 12 mA
$V_{CC} = 2.3V$ to 2.7V	± 8 mA
$V_{CC} = 1.65V$ to 2.3V	± 3 mA
$V_{CC} = 1.4V$ to 1.6V	± 1 mA
Free Air Operating Temperature (T_A)	-40°C to +85°C
Minimum Input Edge Rate ($\Delta t/\Delta V$)	
$V_{IN} = 0.8V$ to 2.0V, $V_{CC} = 3.0V$	10 ns/V

Note 2: The Absolute Maximum Ratings are those values beyond which the safety of the device cannot be guaranteed. The device should not be operated at these limits. The parametric values defined in the Electrical Characteristics tables are not guaranteed at the Absolute Maximum Ratings. The "Recommended Operating Conditions" table will define the conditions for actual device operation.

Note 3: I_O Absolute Maximum Rating must be observed.

Note 4: Floating or unused inputs must be held HIGH or LOW.

DC Electrical Characteristics

Symbol	Parameter	Conditions	V_{CC} (V)	Min	Max	Units
V_{IH}	HIGH Level Input Voltage		2.7 - 3.6	2.0		V
			2.3 - 2.7	1.6		
			1.65 - 2.3	$0.65 \times V_{CC}$		
			1.4 - 1.6	$0.65 \times V_{CC}$		
V_{IL}	LOW Level Input Voltage		2.7 - 3.6		0.8	V
			2.3 - 2.7		0.7	
			1.65 - 2.3		$0.35 \times V_{CC}$	
			1.4 - 1.6		$0.35 \times V_{CC}$	
V_{OH}	HIGH Level Output Voltage	$I_{OH} = -100 \mu A$	2.7 - 3.6	$V_{CC} - 0.2$		V
		$I_{OH} = -6$ mA	2.7	2.2		
		$I_{OH} = -8$ mA	3.0	2.4		
		$I_{OH} = -12$ mA	3.0	2.2		
		$I_{OH} = -100 \mu A$	2.3 - 2.7	$V_{CC} - 0.2$		
		$I_{OH} = -4$ mA	2.3	2.0		
		$I_{OH} = -6$ mA	2.3	1.8		
		$I_{OH} = -8$ mA	2.3	1.7		
		$I_{OH} = -100 \mu A$	1.65 - 2.3	$V_{CC} - 0.2$		
		$I_{OH} = -3$ mA	1.65	1.25		
		$I_{OH} = -100 \mu A$	1.4 - 1.6	$V_{CC} - 0.2$		
		$I_{OH} = -1$ mA	1.4	1.05		

DC Electrical Characteristics (Continued)

Symbol	Parameter	Conditions	V _{CC} (V)	Min	Max	Units
V _{OL}	LOW Level Output Voltage	I _{OL} = 100 μA	2.7 - 3.6		0.2	V
		I _{OL} = 6 mA	2.7	0.4		
		I _{OL} = 8 mA	3.0	0.55		
		I _{OL} = 12 mA	3.0	0.8		
		I _{OL} = 100 μA	2.3 - 2.7	0.2		
		I _{OL} = 6 mA	2.3	0.4		
		I _{OL} = 8 mA	2.3	0.6		
		I _{OL} = 100 μA	1.65 - 2.3		0.2	
		I _{OL} = 3 mA	1.65	0.3		
		I _{OL} = 100 μA	1.4 - 1.6		0.2	
		I _{OL} = 1 mA	1.4	0.35		
I _I	Input Leakage Current	0 ≤ V _I ≤ 3.6V	1.4 - 3.6		±5.0	μA
I _{OZ}	3-STATE Output Leakage	0 ≤ V _O ≤ 3.6V, V _I = V _{IH} or V _{IL}	1.4 - 3.6		±10.0	μA
I _{OFF}	Power-OFF Leakage Current	0 ≤ (V _I , V _O) ≤ 3.6V	0		10.0	μA
I _{CC}	Quiescent Supply Current	V _I = V _{CC} or GND	1.4 - 3.6		20.0	μA
		V _{CC} ≤ (V _I , V _O) ≤ 3.6V (Note 5)	1.4 - 3.6		±20.0	
ΔI _{CC}	Increase in I _{CC} per Input	V _{IH} = V _{CC} - 0.6V	2.7 - 3.6		750	μA

Note 5: Outputs disabled or 3-STATE only.

AC Electrical Characteristics (Note 6)

Symbol	Parameter	Conditions	V _{CC} (V)	T _A = 40°C to +85°C		Units	Figure Number
				Min	Max		
f _{MAX}	Maximum Clock Frequency	C _L = 30 pF, R _L = 500Ω	3.3 ± 0.3	250		ns	
			2.5 ± 0.2	200			
			1.8 ± 0.15	100			
		C _L = 15 pF, R _L = 2kΩ	1.5 ± 0.1	80			
t _{PHL} t _{PLH}	Propagation Delay CP _n to O _n	C _L = 30 pF, R _L = 500Ω	3.3 ± 0.3	0.8	3.4	ns	Figures 1, 2
			2.5 ± 0.2	1.0	4.8		
			1.8 ± 0.15	1.5	9.6		
		C _L = 15 pF, R _L = 2kΩ	1.5 ± 0.1	1.0	19.2		Figures 7, 8
t _{PZL} t _{PZH}	Output Enable Time	C _L = 30 pF, R _L = 500Ω	3.3 ± 0.3	0.8	3.9	ns	Figures 1, 3, 4
			2.5 ± 0.2	1.0	5.4		
			1.8 ± 0.15	1.5	9.8		
		C _L = 15 pF, R _L = 2kΩ	1.5 ± 0.1	1.0	19.6		Figures 7, 9, 10
t _{PLZ} t _{PHZ}	Output Disable Time	C _L = 30 pF, R _L = 500Ω	3.3 ± 0.3	0.8	4.0	ns	Figures 1, 3, 4
			2.5 ± 0.2	1.0	4.4		
			1.8 ± 0.15	1.5	7.9		
		C _L = 15 pF, R _L = 2kΩ	1.5 ± 0.1	1.0	15.8		Figures 7, 9, 10
t _S	Setup Time	C _L = 30 pF, R _L = 500Ω	3.3 ± 0.3	1.5		ns	Figures 1, 6
			2.5 ± 0.2	1.5			
			1.8 ± 0.15	2.5			
		C _L = 15 pF, R _L = 2kΩ	1.5 ± 0.1	3.0			Figures 6, 7
t _H	Hold Time	C _L = 30 pF, R _L = 500Ω	3.3 ± 0.3	1.0		ns	Figures 1, 6
			2.5 ± 0.2	1.0			
			1.8 ± 0.15	1.0			
		C _L = 15 pF, R _L = 2kΩ	1.5 ± 0.1	2.0			Figures 6, 7

AC Electrical Characteristics (Continued)							
Symbol	Parameter	Conditions	V _{CC} (V)	T _A = 40°C to +85°C		Units	Figure Number
				Min	Max		
t _W	Pulse Width	C _L = 30 pF, R _L = 500Ω	3.3 ± 0.3	1.5		ns	Figures 1, 5
			2.5 ± 0.2	1.5			
			1.8 ± 0.15	4.0			
		C _L = 15 pF, R _L = 2kΩ	1.5 ± 0.1	4.0			Figures 5, 7
t _{OSSL}	Output to Output Skew (Note 7)	C _L = 30 pF, R _L = 500Ω	3.3 ± 0.3		0.5	ns	
t _{OSLH}			2.5 ± 0.2		0.5		
			1.8 ± 0.15		0.75		
			1.5 ± 0.1		1.5		
<p>Note 6: For C_L = 50pF, add approximately 300 ps to the AC maximum specification.</p> <p>Note 7: Skew is defined as the absolute value of the difference between the actual propagation delay for any two separate outputs of the same device. The specification applies to any outputs switching in the same direction, either HIGH-to-LOW (t_{OSSL}) or LOW-to-HIGH (t_{OSLH}).</p>							
Dynamic Switching Characteristics							
Symbol	Parameter	Conditions	V _{CC} (V)	T _A = +25°C		Units	
				Typical			
V _{OLP}	Quiet Output Dynamic Peak V _{OL}	C _L = 30 pF, V _{IH} = V _{CC} , V _{IL} = 0V	1.8	0.15	V		
			2.5	0.25			
			3.3	0.35			
V _{OLV}	Quiet Output Dynamic Valley V _{OL}	C _L = 30 pF, V _{IH} = V _{CC} , V _{IL} = 0V	1.8	-0.15	V		
			2.5	-0.25			
			3.3	-0.35			
V _{OHV}	Quiet Output Dynamic Valley V _{OH}	C _L = 30 pF, V _{IH} = V _{CC} , V _{IL} = 0V	1.8	1.55	V		
			2.5	2.05			
			3.3	2.65			
Capacitance							
Symbol	Parameter	Conditions	T _A = +25°C		Units		
			Typical				
C _{IN}	Input Capacitance	V _{CC} = 1.8V, 2.5V or 3.3V, V _I = 0V or V _{CC}	6.0		pF		
C _{OUT}	Output Capacitance	V _I = 0V or V _{CC} , V _{CC} = 1.8V, 2.5V or 3.3V	7.0		pF		
C _{PD}	Power Dissipation Capacitance	V _I = 0V or V _{CC} , f = 10 MHz, V _{CC} = 1.8V, 2.5V or 3.3V	20.0		pF		

AC Loading and Waveforms ($V_{CC} 3.3V \pm 0.3V$ to $1.8V \pm 0.15V$)

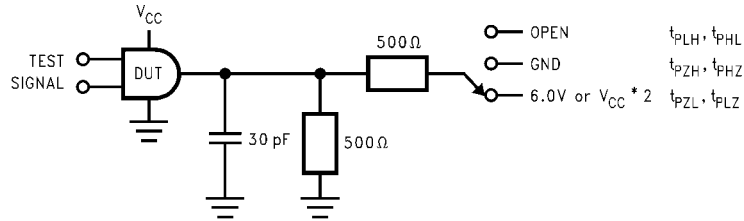

TEST	SWITCH
t_{PLH}, t_{PHL}	Open
t_{PZL}, t_{PLZ}	6V at $V_{CC} = 3.3 \pm 0.3V$; $V_{CC} \times 2$ at $V_{CC} = 2.5 \pm 0.2V; 1.8V \pm 0.15V$
t_{PZH}, t_{PHZ}	GND

FIGURE 1. AC Test Circuit

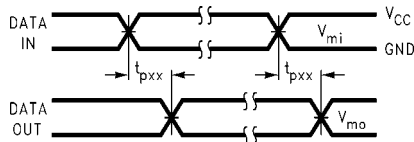

FIGURE 2. Waveform for Inverting and Non-Inverting Functions

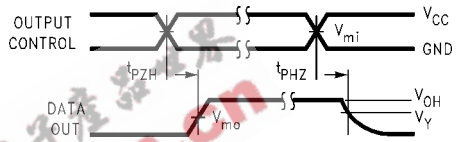

FIGURE 3. 3-STATE Output High Enable and Disable Times for Low Voltage Logic

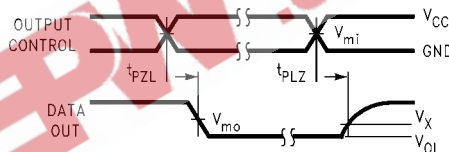

FIGURE 4. 3-STATE Output Low Enable and Disable Times for Low Voltage Logic

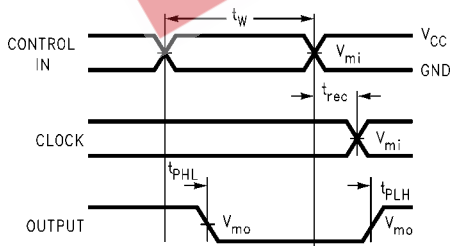

FIGURE 5. Propagation Delay, Pulse Width and t_{REC} Waveforms

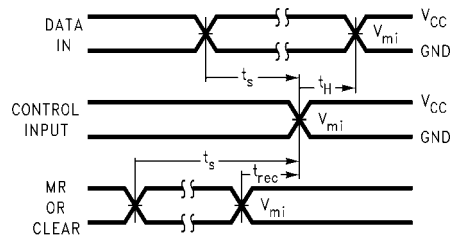
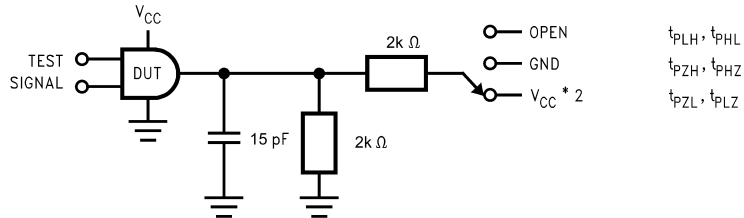

FIGURE 6. Setup Time, Hold Time and Recovery Time for Low Voltage Logic

Symbol	V_{CC}		
	$3.3V \pm 0.3V$	$2.5V \pm 0.2V$	$1.8V \pm 0.15V$
V_{mi}	1.5V	$V_{CC}/2$	$V_{CC}/2$
V_{mo}	1.5V	$V_{CC}/2$	$V_{CC}/2$
V_X	$V_{OL} + 0.3V$	$V_{OL} + 0.15V$	$V_{OL} + 0.15V$
V_Y	$V_{OH} - 0.3V$	$V_{OH} - 0.15V$	$V_{OH} - 0.15V$

AC Loading and Waveforms ($V_{CC} 1.5V \pm 0.1V$)



TEST	SWITCH
t_{PLH}, t_{PHL}	Open
t_{PZL}, t_{PLZ}	$V_{CC} \times 2$ at $V_{CC} = 1.5 \pm 0.1V$
t_{PZH}, t_{PHZ}	GND

FIGURE 7. AC Test Circuit

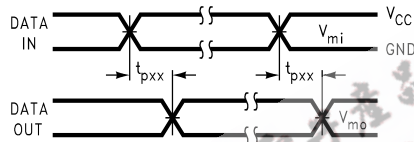

FIGURE 8. Waveform for Inverting and Non-Inverting Functions

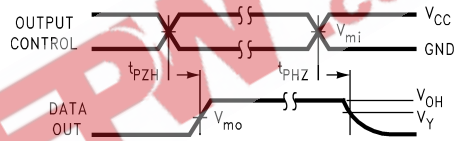

FIGURE 9. 3-STATE Output High Enable and Disable Times for Low Voltage Logic

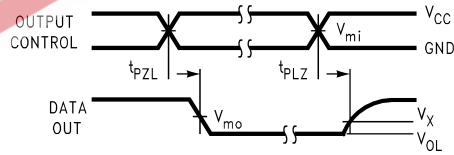
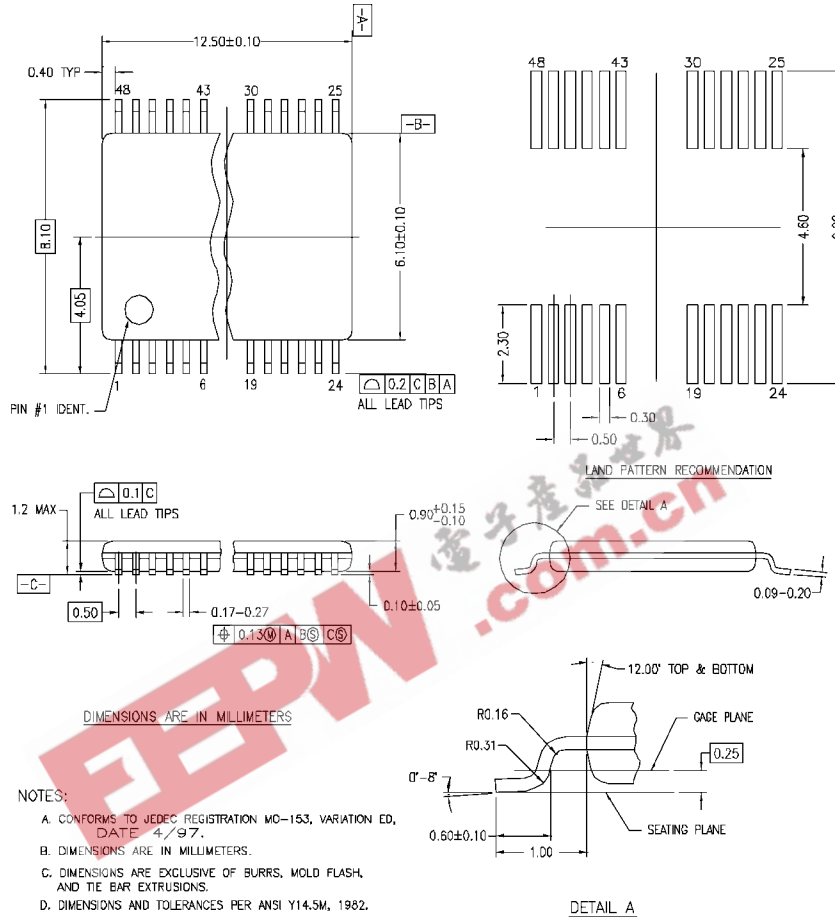

FIGURE 10. 3-STATE Output Low Enable and Disable Times for Low Voltage Logic

Symbol	V_{CC}
	$1.5V \pm 0.1V$
V_{mi}	$V_{CC}/2$
V_{mo}	$V_{CC}/2$
V_X	$V_{OL} + 0.1V$
V_Y	$V_{OH} - 0.1V$

Physical Dimensions inches (millimeters) unless otherwise noted



MTD48REVC

48-Lead Thin Shrink Small Outline Package (TSSOP), JEDEC MO-153, 6.1mm Wide Package Number MTD48

Fairchild does not assume any responsibility for use of any circuitry described, no circuit patent licenses are implied and Fairchild reserves the right at any time without notice to change said circuitry and specifications.

LIFE SUPPORT POLICY

FAIRCHILD'S PRODUCTS ARE NOT AUTHORIZED FOR USE AS CRITICAL COMPONENTS IN LIFE SUPPORT DEVICES OR SYSTEMS WITHOUT THE EXPRESS WRITTEN APPROVAL OF THE PRESIDENT OF FAIRCHILD SEMICONDUCTOR CORPORATION. As used herein:

1. Life support devices or systems are devices or systems which, (a) are intended for surgical implant into the body, or (b) support or sustain life, and (c) whose failure to perform when properly used in accordance with instructions for use provided in the labeling, can be reasonably expected to result in a significant injury to the user.
2. A critical component in any component of a life support device or system whose failure to perform can be reasonably expected to cause the failure of the life support device or system, or to affect its safety or effectiveness.

www.fairchildsemi.com