

DATA SHEET

For a complete data sheet, please also download:

- The IC06 74HC/HCT/HCU/HCMOS Logic Family Specifications
- The IC06 74HC/HCT/HCU/HCMOS Logic Package Information
- The IC06 74HC/HCT/HCU/HCMOS Logic Package Outlines

EEPW 电子产品世界
.com.cn

74HC/HCT7404

5-Bit x 64-word FIFO register;
3-state

Product specification
Supersedes data of October 1990
File under Integrated Circuits, IC06

September 1993

5-Bit x 64-word FIFO register; 3-state

74HC/HCT7404

FEATURES

- Synchronous or asynchronous operation
- 3-state outputs
- 30 MHz (typical) shift-in and shift-out rates
- Readily expandable in word and bit dimensions
- Pinning arranged for easy board layout: input pins directly opposite output pins
- Output capability: driver (8 mA)
- I_{CC} category: LSI.

APPLICATIONS

- High-speed disc or tape controller
- Communications buffer.

GENERAL DESCRIPTION

The 74HC/HCT7404 are high-speed Si-gate CMOS devices specified in compliance with JEDEC standard no.7A.

The "7404" is an expandable, First-In First-Out (FIFO) memory organized as 64 words by 5 bits. A guaranteed 15 MHz data-rate makes it ideal for high-speed applications. A higher data-rate can be obtained in applications where the status flags are not used (burst-mode).

With separate controls for shift-in (SI) and shift-out (\overline{SO}), reading and writing operations are completely independent, allowing synchronous and asynchronous data transfers. Additional controls include a master-reset input (\overline{MR}), an output enable input (\overline{OE}) and flags. The data-in-ready (DIR) and data-out-ready (DOR) flags indicate the status of the device.

QUICK REFERENCE DATA

GND = 0 V; T_{amb} = 25 °C; t_r = t_f = 6 ns.

SYMBOL	PARAMETER	CONDITIONS	TYP.		UNIT
			HC	HCT	
t _{PHL} /t _{PLH}	propagation delay \overline{SO} , SI to DIR and DOR	C _L = 15 pF; V _{CC} = 5 V	15	17	ns
f _{max}	maximum clock frequency		30	30	MHz
C _I	input capacitance		3.5	3.5	pF
C _{PD}	power dissipation capacitance per package	note 1	475	490	pF

Note

1. For HC the condition is V_I = GND to V_{CC}.
For HCT the condition is V_I = GND to V_{CC} - 1.5 V.

ORDERING INFORMATION

EXTENDED TYPE NUMBER	PACKAGE			
	PINS	PIN POSITION	MATERIAL	CODE
74HC/HCT7404N	18	DIL	plastic	SOT102
74HC/HCT7404D	20	SO20	plastic	SOT163A

5-Bit x 64-word FIFO register; 3-state

74HC/HCT7404

PINNING (SOT102)

SYMBOL	PIN	DESCRIPTION
\overline{OE}	1	output enable input (active LOW)
DIR	2	data-in-ready output
SI	3	shift-in input (active HIGH)
D ₀ to D ₄	4, 5, 6, 7, 8	parallel data inputs
GND	9	ground
\overline{MR}	10	asynchronous master-reset input (active LOW)
Q ₄ to Q ₀	11, 12, 13, 14, 15	data outputs
DOR	16	data-out-ready output
\overline{SO}	17	shift-out input (active LOW)
V _{CC}	18	positive supply voltage

PINNING (SOT163A)

SYMBOL	PIN	DESCRIPTION
\overline{OE}	1	output enable input (active LOW)
DIR	2	data-in-ready output
SI	3	shift-in input (active HIGH)
n.c.	4	not connected
D ₀ to D ₄	5, 6, 7, 8, 9	parallel data inputs
GND	10	ground
\overline{MR}	11	asynchronous master-reset input (active LOW)
Q ₄ to Q ₀	12, 13, 14, 15, 16	data outputs
n.c.	17	not connected
DOR	18	data-out ready output
n.c.	19	not connected
V _{CC}	20	positive supply voltage

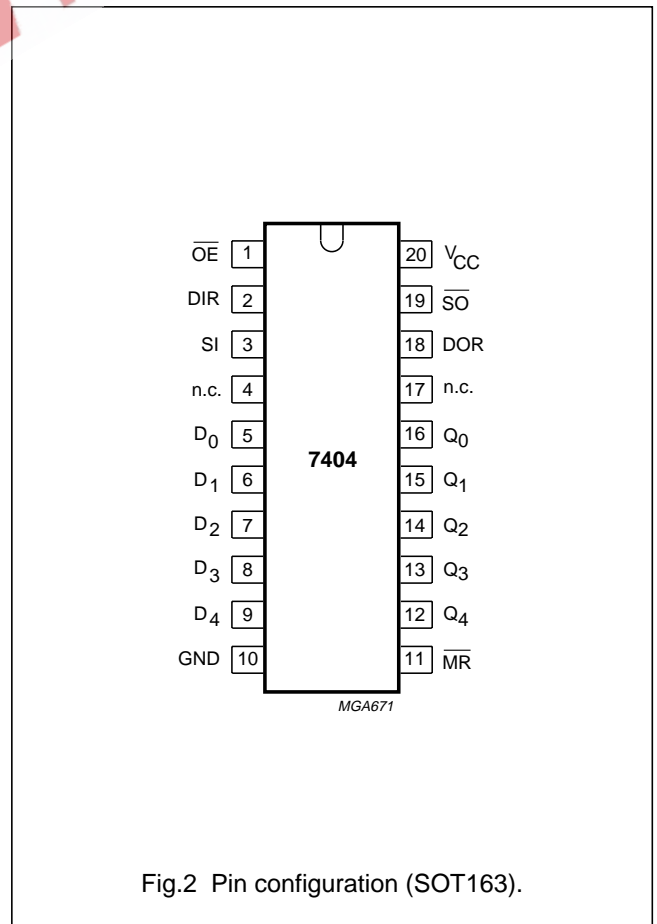
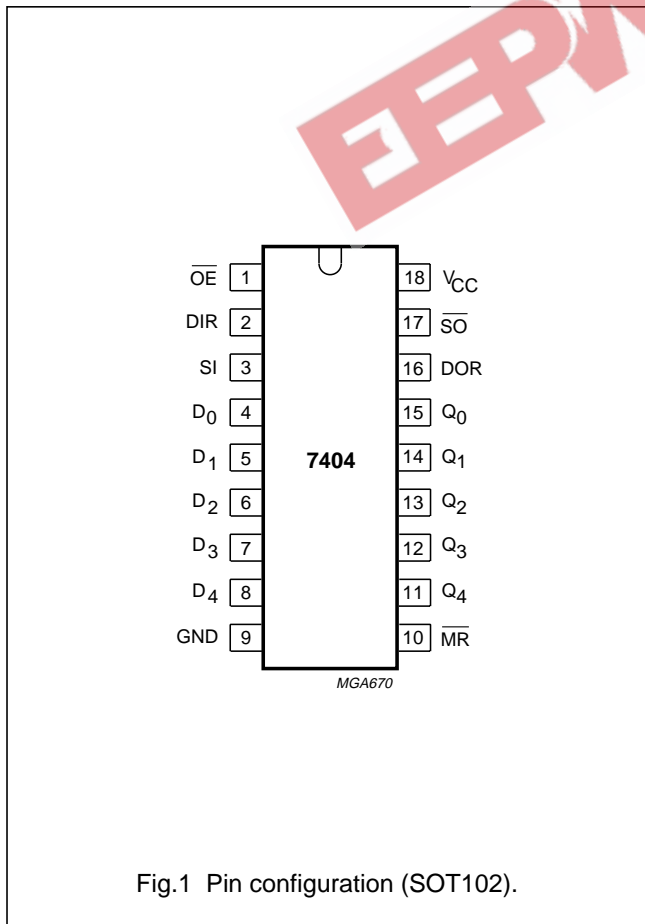

5-Bit x 64-word FIFO register; 3-state

74HC/HCT7404

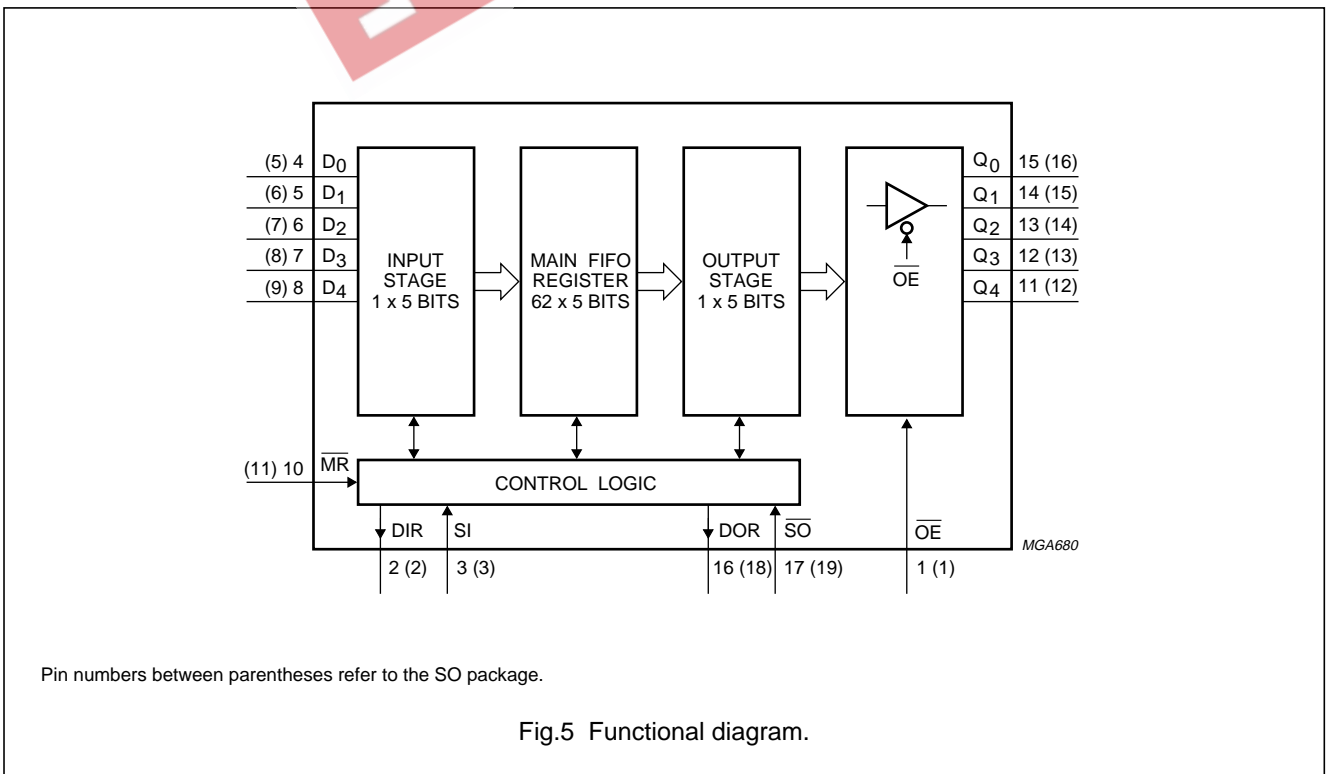
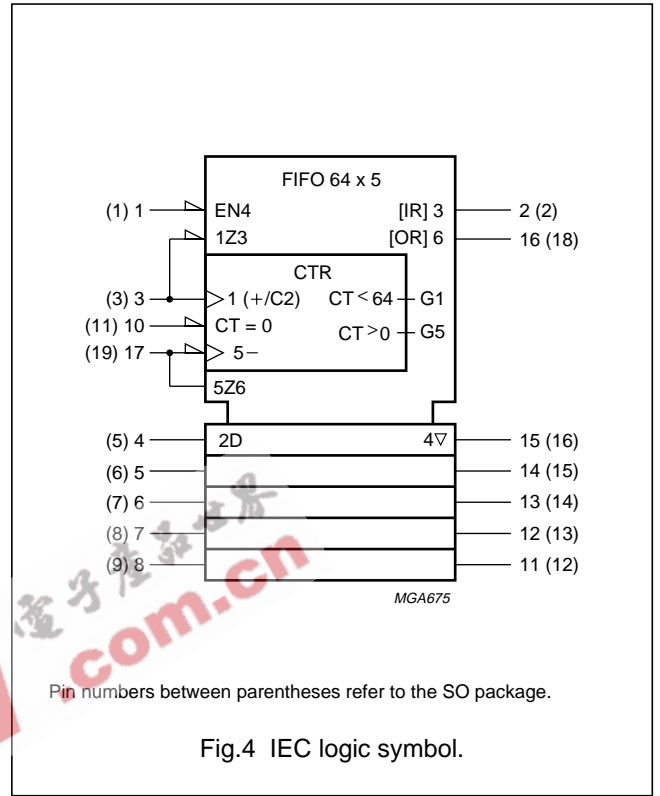
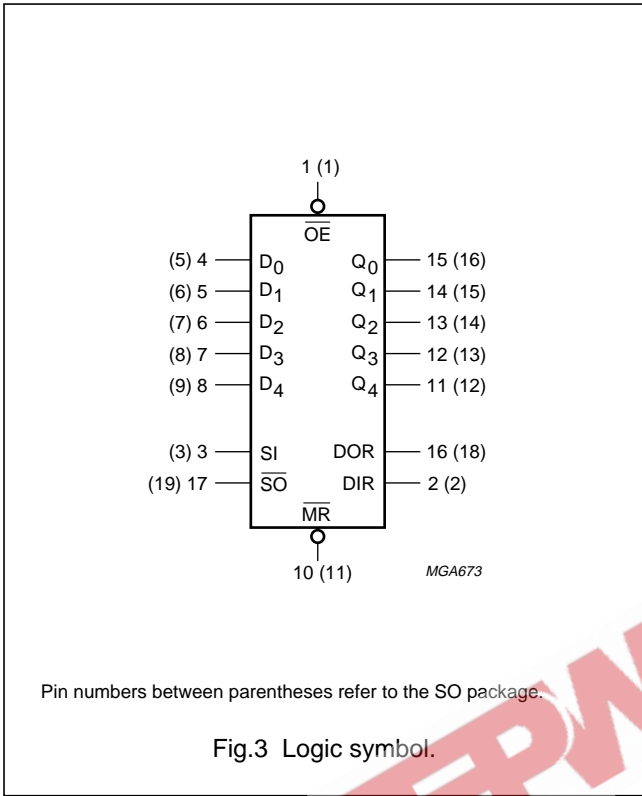

5-Bit x 64-word FIFO register; 3-state

74HC/HCT7404

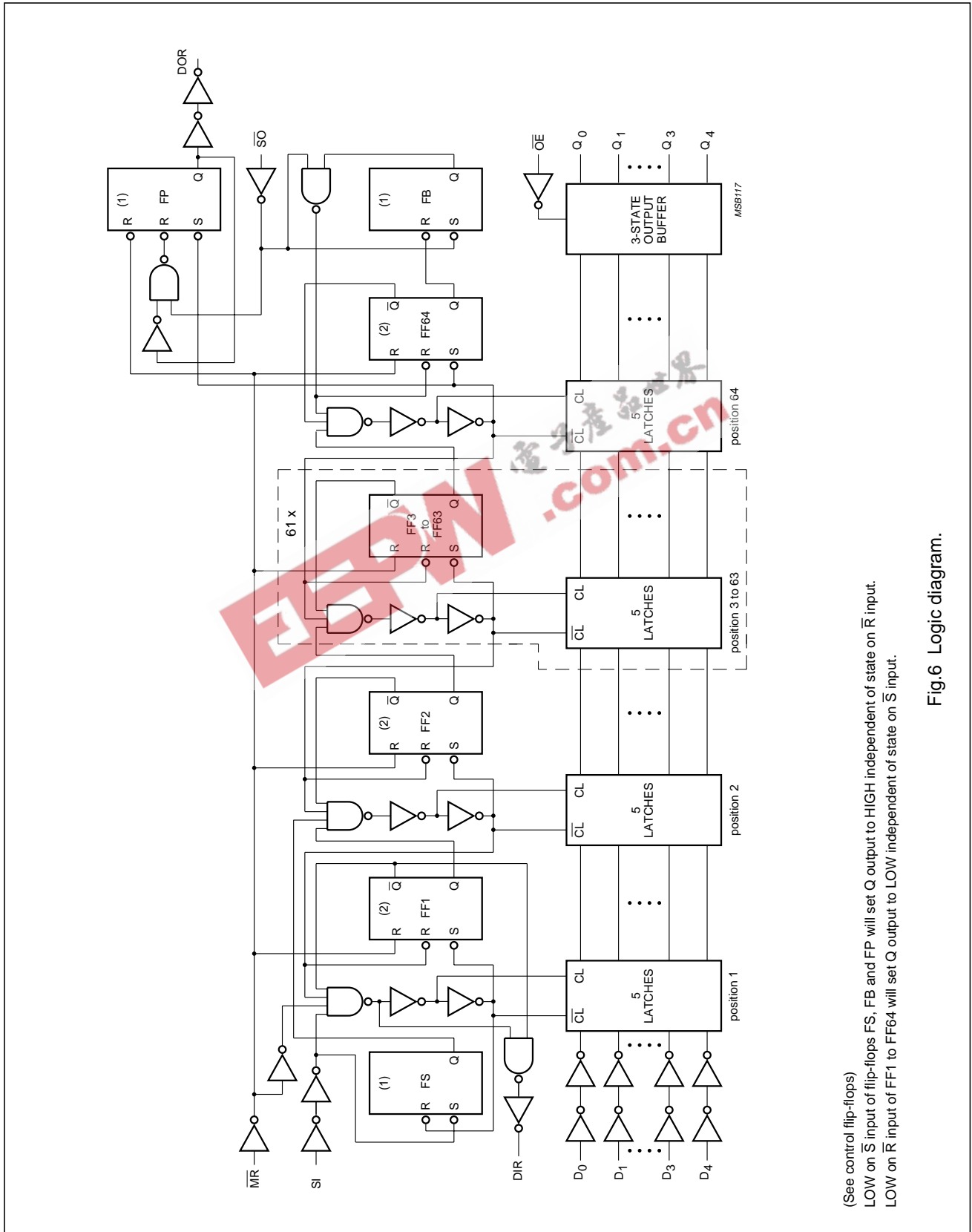

(See control flip-flops)
 LOW on \bar{S} input of flip-flops FS, FB and FP will set Q output to HIGH independent of state on \bar{R} input.
 LOW on \bar{R} input of FF1 to FF64 will set Q output to LOW independent of state on \bar{S} input.

Fig.6 Logic diagram.

5-Bit x 64-word FIFO register; 3-state

74HC/HCT7404

FUNCTIONAL DESCRIPTION

The DIR flag indicates the input stage status, either empty and ready to receive data (DIR = HIGH) or full and busy (DIR = LOW). When DIR and SI are HIGH, data present at D₀ to D₄ is shifted into the input stage; once complete DIR goes LOW. When SI is set LOW, data is automatically shifted to the output stage or to the last empty location. A FIFO which can receive data is indicated by DIR set HIGH.

A DOR flag indicates the output stage status, either data available (DOR = HIGH) or busy (DOR = LOW). When \overline{SO} and DOR are HIGH, data is available at the

outputs (Q₀ to Q₄). When \overline{SO} is LOW new data may be shifted into the output stage, once complete DOR is set LOW.

Expanded Format (see Fig.18)

The DOR and DIR signals are used to allow the '7404' to be cascaded. Both parallel and serial expansion is possible. Serial expansion is only possible with typical devices.

Parallel Expansion

Parallel expansion is accomplished by logically ANDing the DOR and DIR signals to form a composite signal.

Serial Expansion

Serial expansion is accomplished by:

- tying the data outputs of the first device to the data inputs of the second device
- connecting the DOR pin of the first device to the SI pin of the second device
- connecting the \overline{SO} pin of the first device to the DIR pin of the second device.

DC CHARACTERISTICS FOR 74HC

For the DC characteristics see *"74HC/HCT/HCU/HCMOS Logic Family Specifications"*.

Output capability: parallel outputs, bus driver; serial output, standard I_{CC} category: MSI

Output capability: driver 8 mA

I_{CC} category: LSI

Voltages are referenced to GND (ground = 0 V).

DC CHARACTERISTICS FOR 74HC

SYMBOL	PARAMETER	T _{amb} °C							UNIT	TEST CONDITION		
		+25			-40 to +85		-40 to +125			V _{CC} (V)	V _I	OTHER
		MIN	TYP	MAX	MIN	MAX	MIN	MAX				
V _{OH}	HIGH level output voltage	3.98	4.32	–	3.84	–	3.70	–	V	4.5 6	V _{IH} or V _{IL}	I _O = –8 mA I _O = –10 mA
		5.48	5.81	–	5.34	–	5.20	–	V			
V _{OL}	LOW level output voltage	–	0.15	0.26	–	0.33	–	0.4	V	4.5 6	V _{IH} or V _{IL}	I _O = 8 mA I _O = 10 mA
		–	0.15	0.26	–	0.33	–	0.4	V			

5-Bit x 64-word FIFO register; 3-state

74HC/HCT7404

AC CHARACTERISTICS FOR 74HC

GND = 0 V; $t_r = t_f = 6$ ns; $C_L = 50$ pF.

SYMBOL	PARAMETER	T_{amb} °C							UNIT	TEST CONDITION	
		+25			-40 to +85		-40 to +125			V_{CC} (V)	WAVEFORMS
		MIN	TYP	MAX	MIN	MAX	MIN	MAX			
t_{PHL}/t_{PLH}	propagation delay MR to DIR, DOR	-	69	210	-	265	-	315	ns	2.0	Fig.9
		-	25	42	-	53	-	63	ns	4.5	
		-	20	36	-	45	-	54	ns	6.0	
t_{PHL}	propagation delay MR to Q_n	-	52	160	-	200	-	240	ns	2.0	Fig.9
		-	19	32	-	40	-	48	ns	4.5	
		-	15	27	-	34	-	41	ns	6.0	
t_{PHL}/t_{PLH}	propagation delay SI to DIR	-	66	205	-	255	-	310	ns	2.0	Fig.7
		-	24	41	-	51	-	62	ns	4.5	
		-	19	35	-	43	-	53	ns	6.0	
t_{PHL}/t_{PLH}	propagation delay SO to DOR	-	94	290	-	365	-	435	ns	2.0	Fig.10
		-	34	58	-	73	-	87	ns	4.5	
		-	27	49	-	62	-	74	ns	6.0	
t_{PHL}/t_{PLH}	propagation delay DOR to Q_n	-	11	35	-	45	-	55	ns	2.0	Fig.11
		-	4	7	-	9	-	11	ns	4.5	
		-	3	6.0	-	8	-	9	ns	6.0	
t_{PHL}/t_{PLH}	propagation delay SO to Q_n	-	105	325	-	406	-	488	ns	2.0	Fig.15
		-	38	65	-	81	-	98	ns	4.5	
		-	30	55	-	69	-	83	ns	6.0	
t_{PLH}	propagation delay/ripple through delay SI to DOR	-	2.2	7.0	-	8.8	-	10.5	μ s	2.0	Fig.16
		-	0.8	1.4	-	1.8	-	2.1	μ s	4.5	
		-	0.6	1.2	-	1.5	-	1.8	μ s	6.0	
t_{PLH}	propagation delay/bubble-up delay \overline{SO} to DIR	-	2.8	9.0	-	11.2	-	13.5	μ s	2.0	Fig.8
		-	1.0	1.8	-	2.2	-	2.7	μ s	4.5	
		-	0.8	1.5	-	1.9	-	2.3	μ s	6.0	
t_{PZH}/t_{PZL}	3-state output enable \overline{OE} to Q_n	-	44	150	-	190	-	225	ns	2.0	Fig.17
		-	16	30	-	38	-	45	ns	4.5	
		-	13	26	-	32	-	38	ns	6.0	
t_{PHZ}/t_{PLZ}	3-state output disable \overline{OE} to Q_n	-	50	150	-	190	-	225	ns	2.0	Fig.17
		-	18	30	-	38	-	45	ns	4.5	
		-	14	26	-	33	-	38	ns	6.0	
t_{THL}/t_{TLH}	output transition time	-	14	60	-	75	-	90	ns	2.0	Fig.17
		-	5	12	-	15	-	18	ns	4.5	
		-	4	10	-	13	-	15	ns	6.0	
t_w	SI pulse width HIGH or LOW	35	11	-	45	-	55	-	ns	2.0	Fig.7
		7	4	-	9	-	11	-	ns	4.5	
		6	3	-	8	-	9	-	ns	6.0	
t_w	\overline{SO} pulse width HIGH or LOW	70	22	-	90	-	105	-	ns	2.0	Fig.10
		14	8	-	18	-	21	-	ns	4.5	
		12	6	-	15	-	18	-	ns	6.0	

5-Bit x 64-word FIFO register; 3-state

74HC/HCT7404

SYMBOL	PARAMETER	T _{amb} °C							UNIT	TEST CONDITION	
		+25			-40 to +85		-40 to +125			V _{CC} (V)	WAVEFORMS
		MIN	TYP	MAX	MIN	MAX	MIN	MAX			
t _w	DIR pulse width HIGH	10	41	130	8	165	8	195	ns	2.0	Fig.8
		5	15	26	4	33	4	39	ns	4.5	
		4	12	22	3	28	3	33	ns	6.0	
t _w	DOR pulse width HIGH	14	52	160	12	200	12	240	ns	2.0	Fig.11
		7	19	32	6	40	6	48	ns	4.5	
		6	15	27	5	34	5	41	ns	6.0	
t _w	$\overline{\text{MR}}$ pulse width LOW	120	39	–	150	–	180	–	ns	2.0	Fig.9
		24	14	–	30	–	36	–	ns	4.5	
		20	11	–	26	–	31	–	ns	6.0	
t _{rem}	removal time $\overline{\text{MR}}$ to SI	80	24	–	100	–	120	–	ns	2.0	Fig.16
		16	8	–	20	–	24	–	ns	4.5	
		14	7	–	17	–	20	–	ns	6.0	
t _{su}	set-up time D _n to SI	–8	–36	–	–6	–	–6	–	ns	2.0	Fig.14
		–4	–13	–	–3	–	–3	–	ns	4.5	
		–3	–10	–	–3	–	–3	–	ns	6.0	
t _h	hold time D _n to SI	135	44	–	170	–	205	–	ns	2.0	Fig.14
		27	16	–	34	–	41	–	ns	4.5	
		23	13	–	29	–	35	–	ns	6.0	
f _{max}	maximum clock pulse frequency SI, $\overline{\text{SO}}$ burst mode	3.6	9.9	–	2.8	–	2.4	–	MHz	2.0	Fig.12 and Fig.13
		18	30	–	14	–	12	–	MHz	4.5	
		21	36	–	16	–	14	–	MHz	6.0	
f _{max}	maximum clock pulse frequency SI, $\overline{\text{SO}}$ using flags	3.6	9.9	–	2.8	–	2.4	–	MHz	2.0	Fig.7 and Fig.10
		18	30	–	14	–	12	–	MHz	4.5	
		21	36	–	16	–	14	–	MHz	6.0	
f _{max}	maximum clock pulse frequency SI, $\overline{\text{SO}}$ cascaded	–	7.6	–	–	–	–	–	MHz	2.0	Fig.7 and Fig.10
		–	23	–	–	–	–	–	MHz	4.5	
		–	27	–	–	–	–	–	MHz	6.0	

5-Bit x 64-word FIFO register; 3-state

74HC/HCT7404

DC CHARACTERISTICS FOR 74HCT

For the DC characteristics see *"74HC/HCT/HCU/HCMOS Logic Family Specifications"*, except that V_{OH} and V_{OL} are not valid for driver output. They are replaced by the values given below.

Output capability: driver 8 mA

I_{CC} category: LSI.

Voltages are referenced to GND (ground = 0 V).

DC CHARACTERISTICS FOR 74HCT

SYMBOL	PARAMETER	$T_{amb} \text{ } ^\circ\text{C}$							UNIT	TEST CONDITION		
		+25			-40 to +85		-40 to +125			V_{CC} (V)	V_I	OTHER
		MIN	TYP	MAX	MIN	MAX	MIN	MAX				
V_{OH}	HIGH level output voltage	3.98	4.32	–	3.84	–	3.7	–	V	4.5	V_{IH} or V_{IL}	$I_O = -8 \text{ mA}$
V_{OL}	LOW level output voltage	–	0.15	0.26	–	0.33	–	0.40	V	4.5	V_{IH} or V_{IL}	$I_O = 8 \text{ mA}$

Note to HCT types

The value of additional quiescent supply current (ΔI_{CC}) for a unit load of 1 is given in the family specifications. To determine ΔI_{CC} per input, multiply this value by the unit load coefficient shown in the table below.

UNIT LOAD COEFFICIENT

INPUT	UNIT LOAD COEFFICIENT
\overline{OE}	1
SI	1.5
D_n	0.75
\overline{MR}	1.5
\overline{SO}	1.5

5-Bit x 64-word FIFO register; 3-state

74HC/HCT7404

AC CHARACTERISTICS FOR 74HCT

GND = 0 V; $t_r = t_f = 6$ ns; $C_L = 50$ pF.

SYMBOL	PARAMETER	T_{amb} °C							UNIT	TEST CONDITION	
		+25			-40 to +85		-40 to +125			V_{CC} (V)	WAVEFORMS
		MIN	TYP	MAX	MIN	MAX	MIN	MAX			
t_{PHL}/t_{PLH}	propagation delay MR to DIR, DOR	–	30	51	–	53	–	63	ns	4.5	Fig.9
t_{PHL}	propagation delay MR to Q_n	–	22	38	–	48	–	57	ns	4.5	Fig.9
t_{PHL}/t_{PLH}	propagation delay SI to DIR	–	25	43	–	54	–	65	ns	4.5	Fig.7
t_{PHL}/t_{PLH}	propagation delay SO to DOR	–	36	61	–	76	–	92	ns	4.5	Fig.10
t_{PHL}/t_{PLH}	propagation delay SO to Q_n	–	42	72	–	90	–	108	ns	4.5	Fig.15
t_{PHL}/t_{PLH}	propagation delay DOR to Q_n	–	7	12	–	15	–	18	ns	4.5	Fig.11
t_{PLH}	propagation delay/ripple through delay SI to DOR	–	0.8	1.4	–	1.75	–	2.1	μ s	4.5	Fig.11
t_{PLH}	propagation delay/bubble- up delay SO to DIR	–	1	1.8	–	2.25	–	2.7	μ s	4.5	Fig.8
t_{PZH}/t_{PZL}	3-state output enable OE to Q_n	–	16	30	–	38	–	45	ns	4.5	Fig.17
t_{PHZ}/t_{PLZ}	3-state output disable OE to Q_n	–	19	30	–	38	–	45	ns	4.5	Fig.17
t_{THL}/t_{TLH}	output transition time	–	5	12	–	15	–	18	ns	4.5	Fig.17
t_W	SI pulse width HIGH or LOW	9	5	–	6	–	8	–	ns	4.5	Fig.7
t_W	SO pulse width HIGH or LOW	14	8	–	18	–	21	–	ns	4.5	Fig.10
t_W	DIR pulse width HIGH	5	17	29	4	36	4	44	ns	4.5	Fig.8

5-Bit x 64-word FIFO register; 3-state

74HC/HCT7404

SYMBOL	PARAMETER	T _{amb} °C							UNIT	TEST CONDITION	
		+25			-40 to +85		-40 to +125			V _{CC} (V)	WAVEFORMS
		MIN	TYP	MAX	MIN	MAX	MIN	MAX			
t _w	DOR pulse width HIGH	7	21	36	6	45	6	54	ns	4.5	Fig.11
t _w	$\overline{\text{MR}}$ pulse width LOW	26	15	–	33	–	39	–	ns	4.5	Fig.9
t _{rem}	removal time MR to SI	18	10	–	23	–	27	–	ns	4.5	Fig.16
t _{su}	set-up time D _n to SI	–5	–16	–	–4	–	–4	–	ns	4.5	Fig.14
t _h	hold time D _n to SI	30	18	–	38	–	45	–	ns	4.5	Fig.14
f _{max}	maximum clock pulse frequency SI, $\overline{\text{SO}}$ burst mode	18	30	–	14	–	12	–	MHz	4.5	Fig.12 and Fig.13
f _{max}	maximum clock pulse frequency SI, $\overline{\text{SO}}$ using flags	18	30	–	14	–	12	–	MHz	4.5	Fig.7 and Fig.10
f _{max}	maximum clock pulse frequency SI, $\overline{\text{SO}}$ cascaded	–	23	–	–	–	–	–	MHz	4.5	Fig.7 and Fig.10

5-Bit x 64-word FIFO register; 3-state

74HC/HCT7404

AC WAVEFORMS

Shifting in sequence FIFO empty to FIFO full

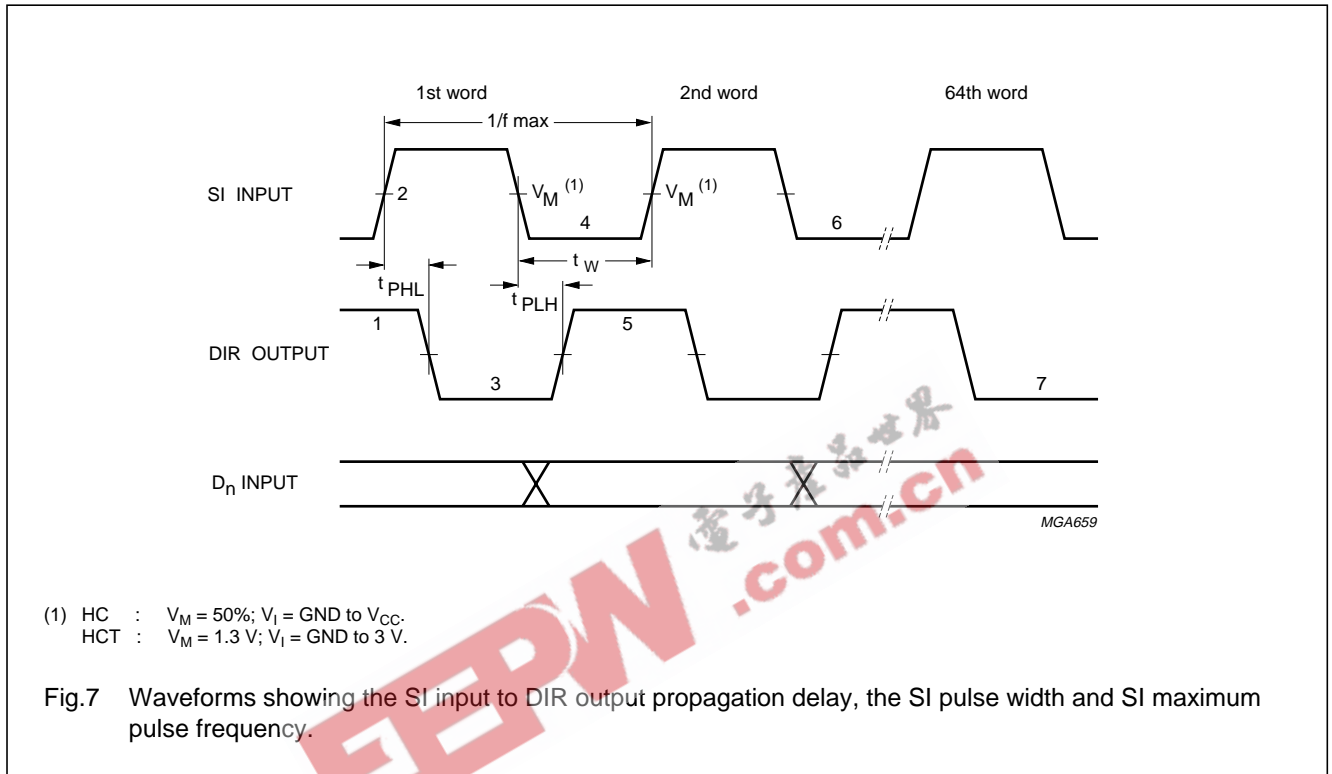

Notes to Fig.7

1. DIR initially HIGH; FIFO is prepared for valid data
2. SI set HIGH; data loaded into input stage
3. DIR goes LOW, input stage "busy"
4. SI set LOW; data from first location "ripple through"
5. DIR goes HIGH, status flag indicates FIFO prepared for additional data
6. Repeat process to load 2nd word through to 64th word into FIFO
 DIR remains LOW; with attempt to shift into full FIFO, no data transfer occurs.

5-Bit x 64-word FIFO register; 3-state

74HC/HCT7404

With FIFO full; SI held HIGH in anticipation of empty location

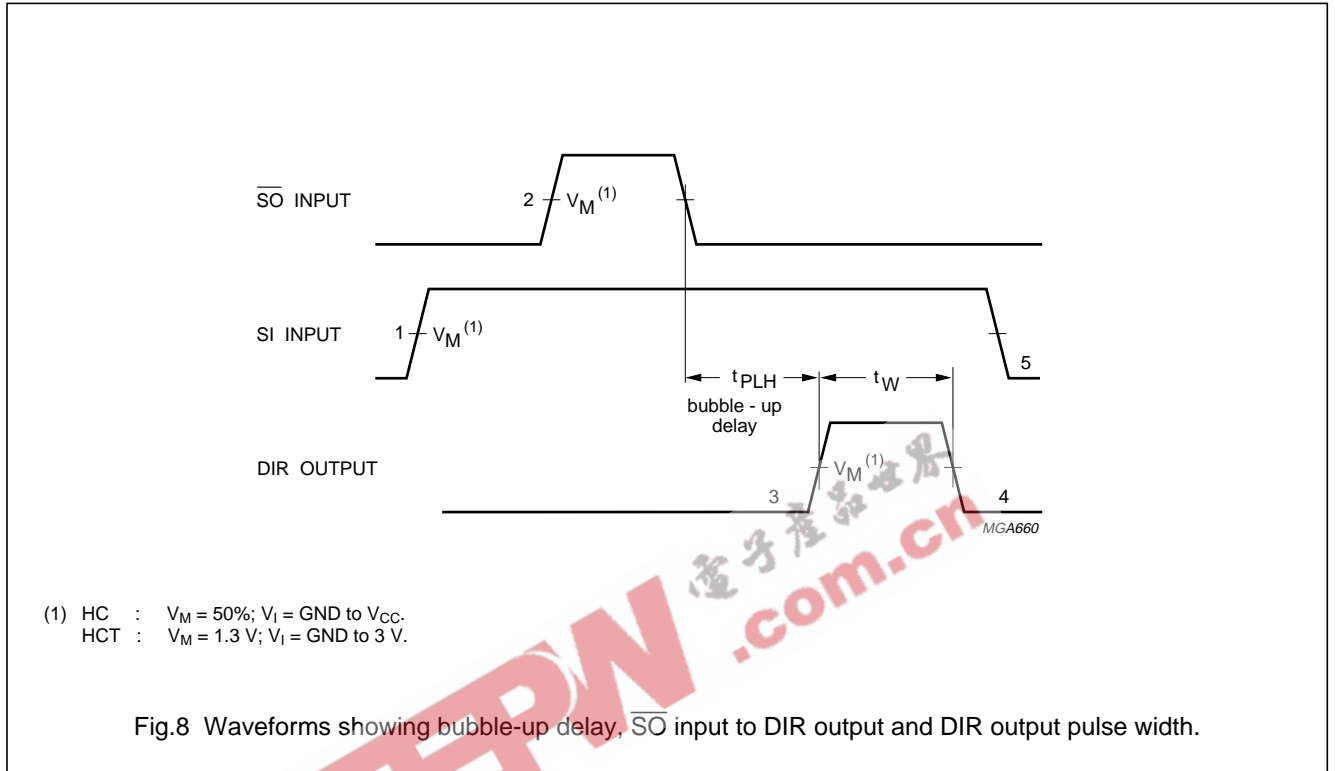

Notes to Fig.8

1. FIFO is initially full, shift-in is held HIGH
2. $\overline{\text{SO}}$ pulse; data in the output stage is unloaded, "bubble-up" process of empty location begins
3. DIR HIGH; when empty location reaches input stage, flag indicates FIFO is prepared for data input
4. DIR returns to LOW; data shift-in to empty location is complete, FIFO is full again
5. SI set LOW; necessary to complete shift-in process, DIR remains LOW, because FIFO is full.

5-Bit x 64-word FIFO register; 3-state

74HC/HCT7404

Master reset applied with FIFO full

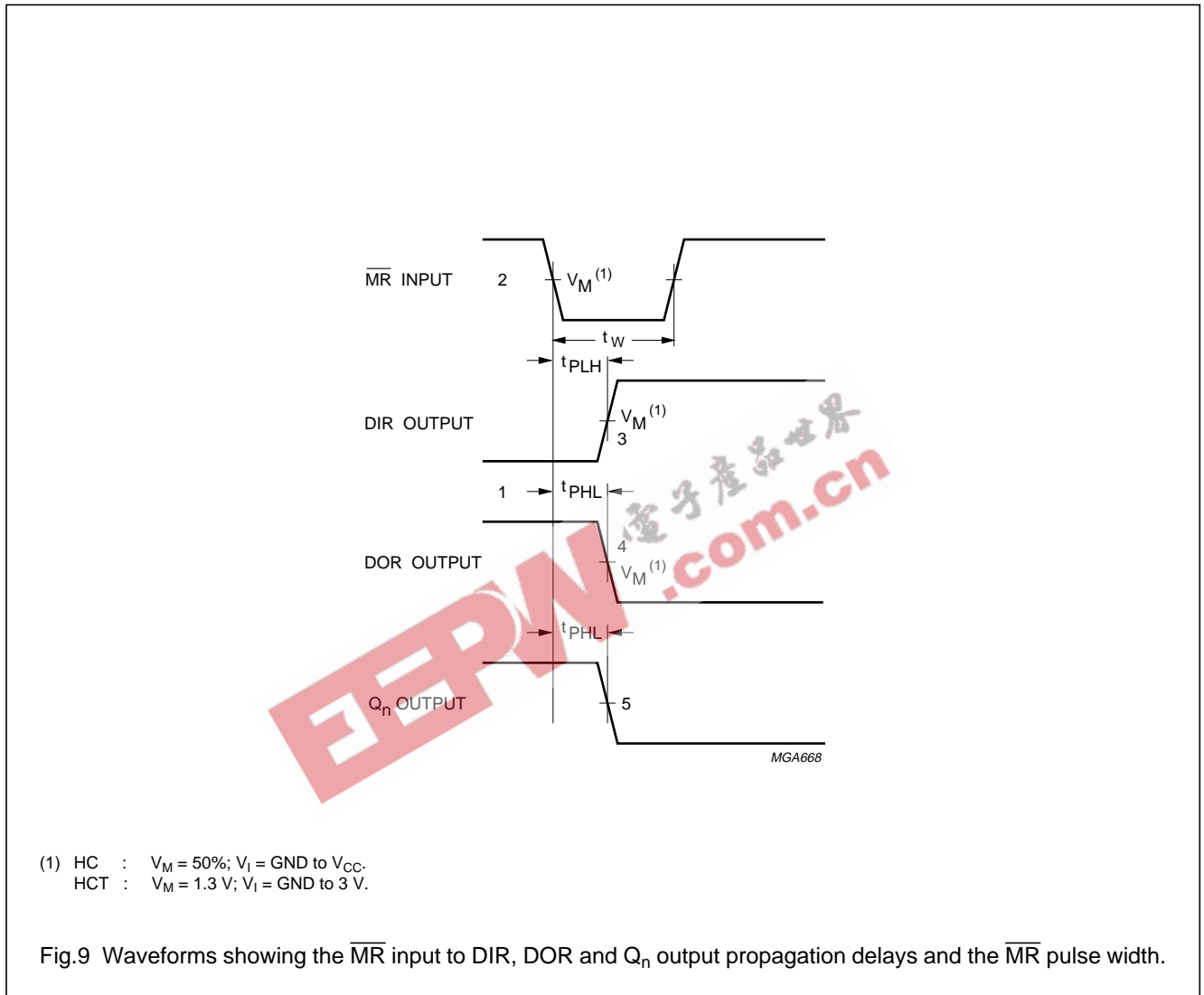

Notes to Fig.9

1. DIR LOW, output ready HIGH; assume FIFO is full
2. $\overline{\text{MR}}$ pulse LOW; clears FIFO
3. DIR goes HIGH; flag indicates input prepared for valid data
4. DOR goes LOW; flag indicates FIFO empty
5. Q_n outputs go LOW (only last bit will be reset).

5-Bit x 64-word FIFO register; 3-state

74HC/HCT7404

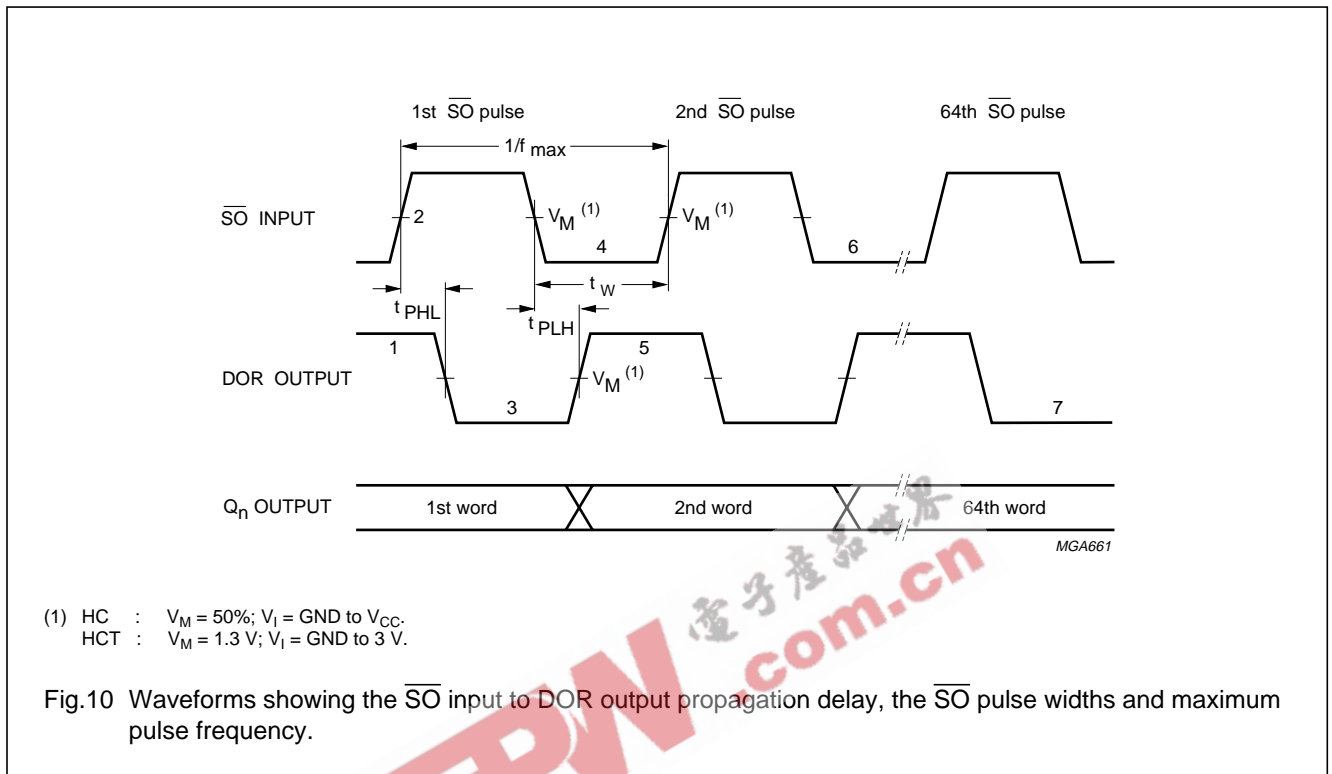

Notes to Fig.10

1. DOR HIGH; no data transfer in progress, valid data is present at output stage
2. $\overline{S_O}$ set HIGH; results in DOR going LOW
3. DOR goes LOW; output stage "busy"
4. $\overline{S_O}$ set LOW; data in the input stage is unloaded, and new data replaces it as empty location "bubbles-up" to input stage
5. DOR goes HIGH; transfer process completed, valid data present at output after the specified propagation delay
6. Repeat process to unload the 3rd through to the 64th word from FIFO.
7. DOR remains LOW; FIFO is empty.

5-Bit x 64-word FIFO register; 3-state

74HC/HCT7404

With FIFO empty; \overline{SO} is held HIGH in anticipation

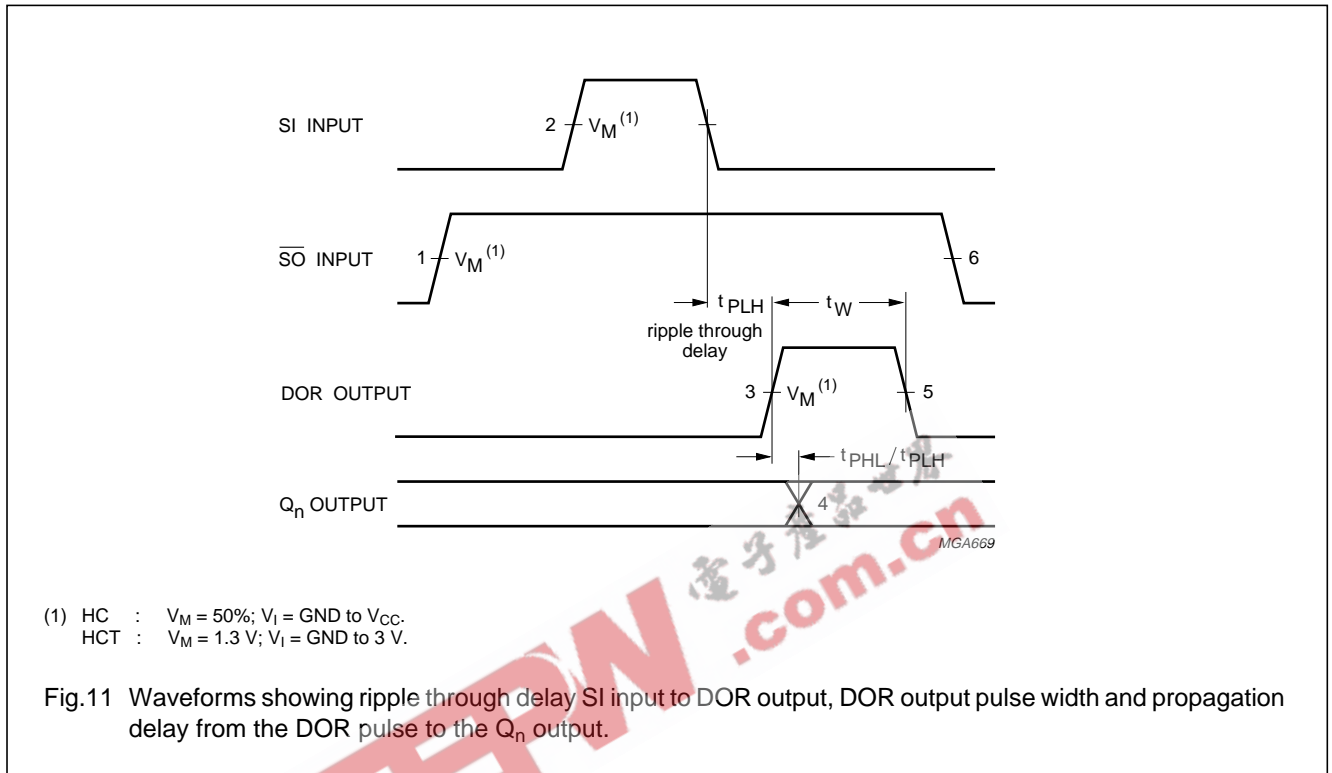

Notes to Fig.11

1. FIFO is initially empty, \overline{SO} is held HIGH
2. SI pulse; loads data into FIFO and initiates ripple through process
3. DOR flag signals the arrival of valid data at the output stage
4. Output transition; data arrives at output stage after the specified propagation delay between the rising edge of the DOR pulse to the Q_n output
5. DOR goes LOW; data shift-out is complete, FIFO is empty again
6. \overline{SO} set LOW; necessary to complete shift-out process. DOR remains LOW, because FIFO is empty.

5-Bit x 64-word FIFO register; 3-state

74HC/HCT7404

Shift-in operation; high-speed burst mode

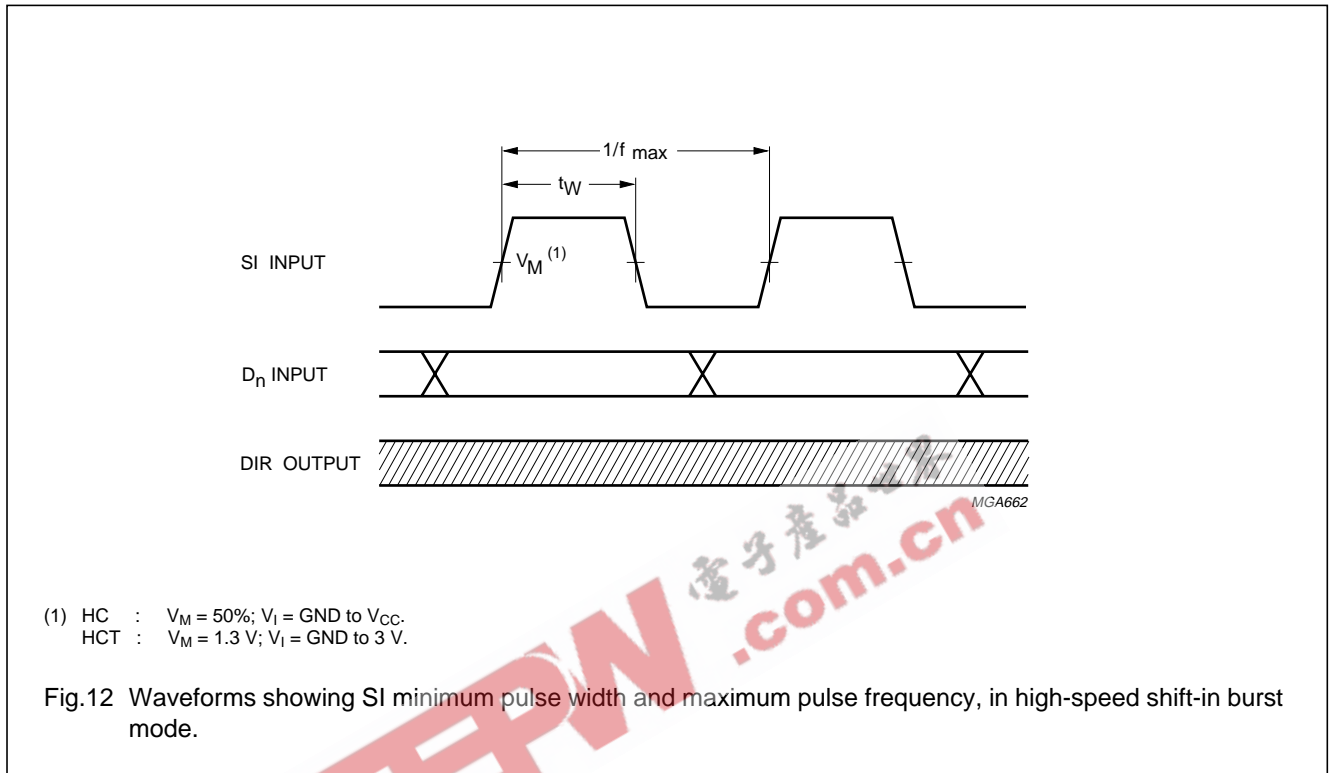

Note to Fig.12

In the high-speed mode, the burst-in rate is determined by the minimum shift-in HIGH and shift-in LOW specifications. The DIR status flag is a don't care condition, and a shift-in pulse can be applied regardless of the flag. A SI pulse which would overflow the storage capacity of the FIFO is ignored.

5-Bit x 64-word FIFO register; 3-state

74HC/HCT7404

Shift-out operation; high-speed burst mode

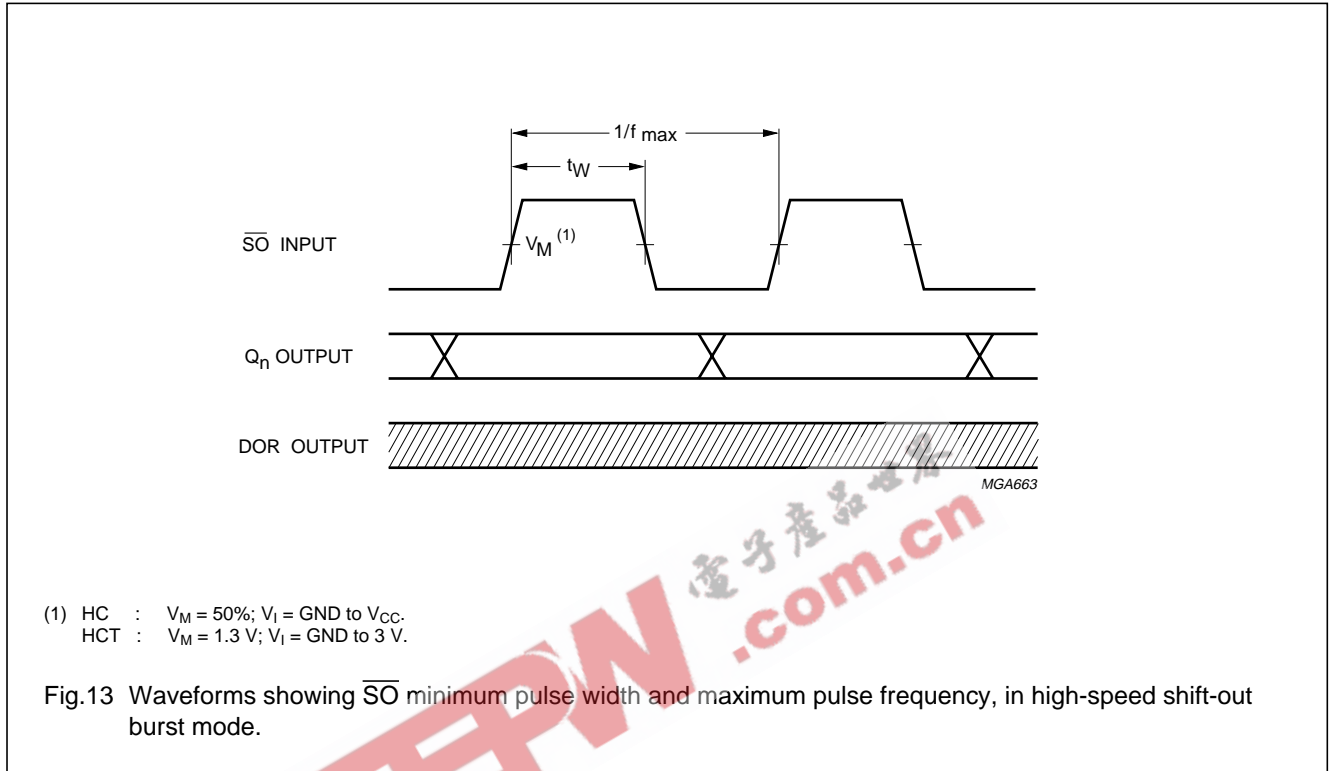

Note to Fig.13

In the high-speed mode, the burst-out rate is determined by the minimum shift-out HIGH and shift-out LOW specifications. The DOR flag is a don't care condition and an $\overline{\text{SO}}$ pulse can be applied without regard to the flag.

5-Bit x 64-word FIFO register; 3-state

74HC/HCT7404

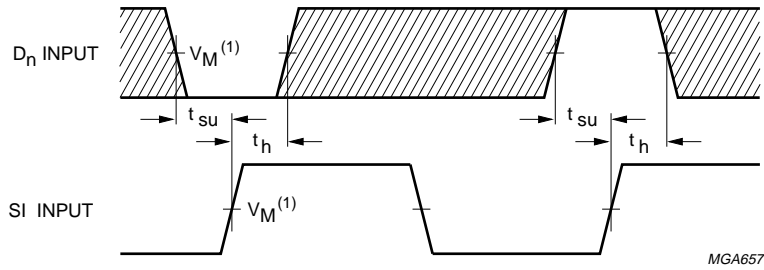

- (1) HC : $V_M = 50\%$; $V_I = \text{GND to } V_{CC}$.
- HCT : $V_M = 1.3 \text{ V}$; $V_I = \text{GND to } 3 \text{ V}$.

The shaded areas indicate when the input is permitted to change for predictable output performance.

Fig.14 Waveforms showing hold and set-up times for D_n input to SI input.

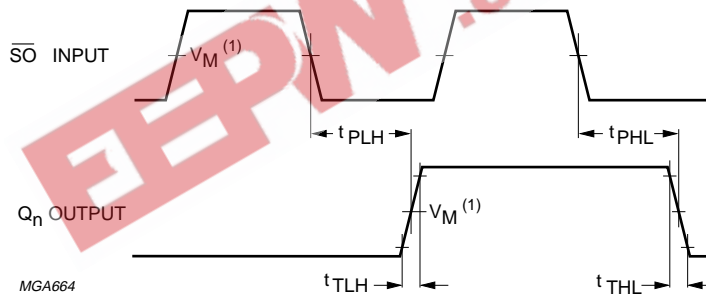

- (1) HC : $V_M = 50\%$; $V_I = \text{GND to } V_{CC}$.
- HCT : $V_M = 1.3 \text{ V}$; $V_I = \text{GND to } 3 \text{ V}$.

Fig.15 Waveforms showing \overline{SO} input to Q_n output propagation delays and output transition time.

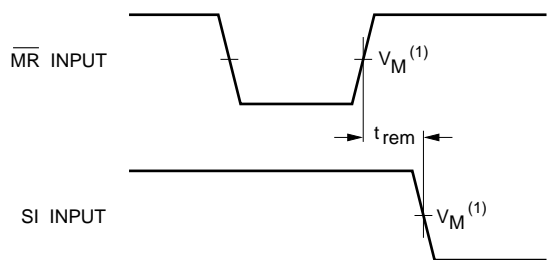

- (1) HC : $V_M = 50\%$; $V_I = \text{GND to } V_{CC}$.
- HCT : $V_M = 1.3 \text{ V}$; $V_I = \text{GND to } 3 \text{ V}$.

Fig.16 Waveform showing the \overline{MR} input to SI input removal time.

5-Bit x 64-word FIFO register; 3-state

74HC/HCT7404

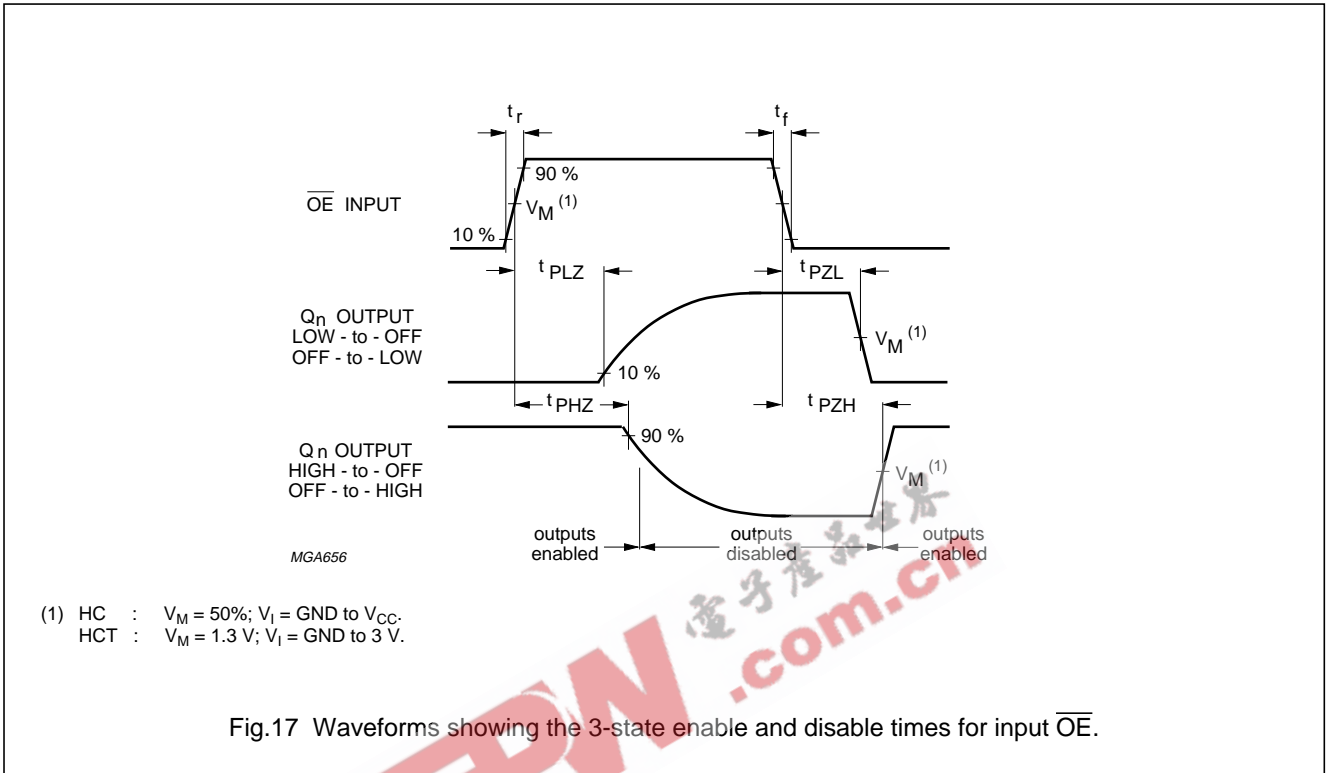

5-Bit x 64-word FIFO register; 3-state

74HC/HCT7404

APPLICATION INFORMATION

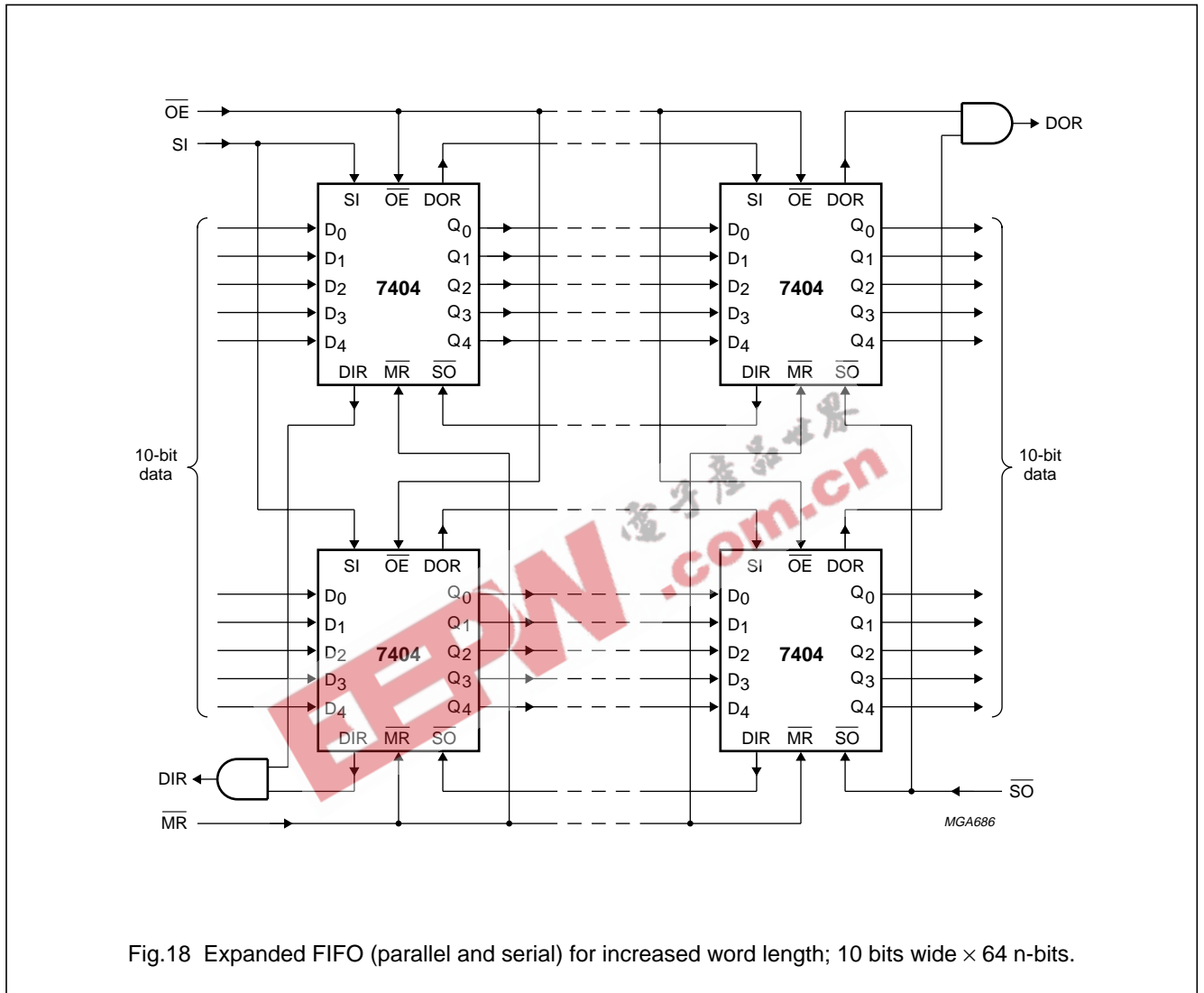

Fig.18 Expanded FIFO (parallel and serial) for increased word length; 10 bits wide x 64 n-bits.

5-Bit x 64-word FIFO register; 3-state

74HC/HCT7404

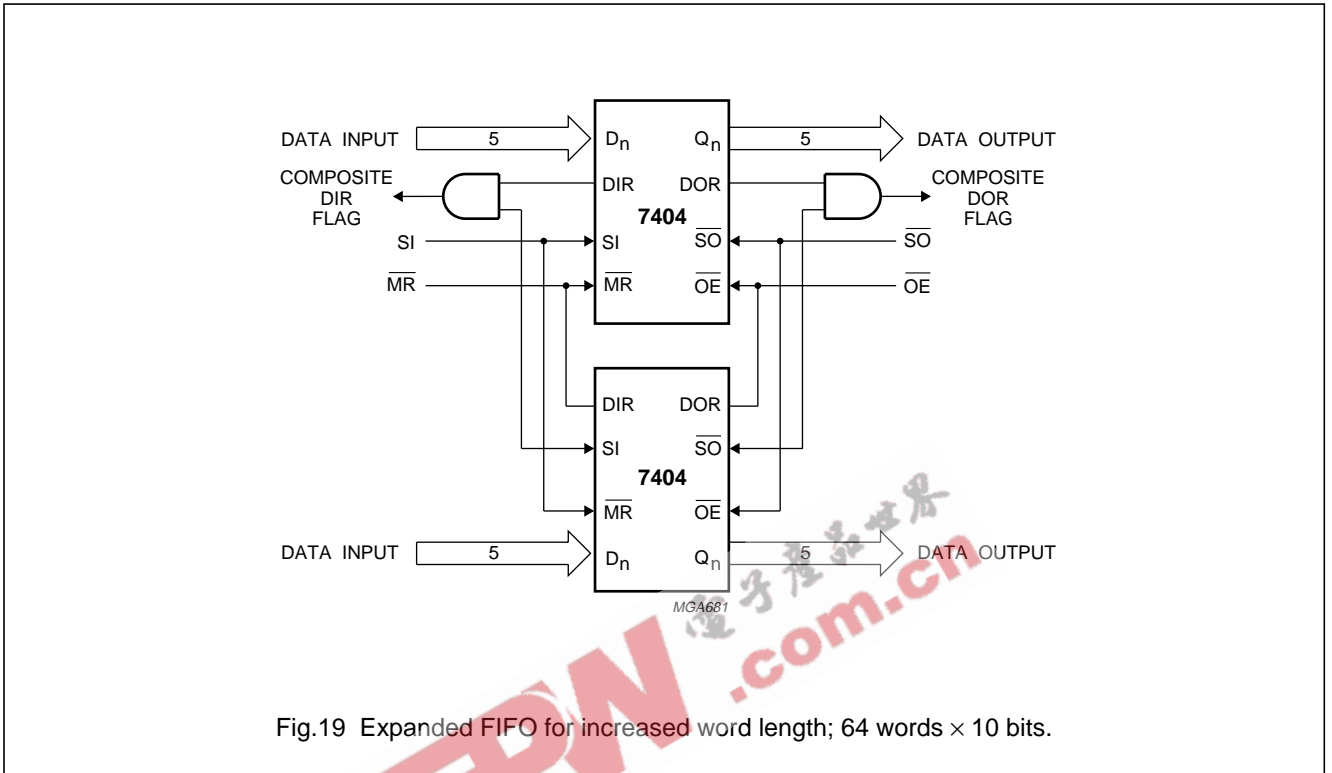

Fig.19 Expanded FIFO for increased word length; 64 words x 10 bits.

Note to Fig.19

The "7404" is easily expanded to increase word length. Composite DIR and DOR flags are formed with the addition of an AND gate. The basic operation and timing are identical to a single FIFO, with the exception of an added gate delay on the flags.

5-Bit x 64-word FIFO register; 3-state

74HC/HCT7404

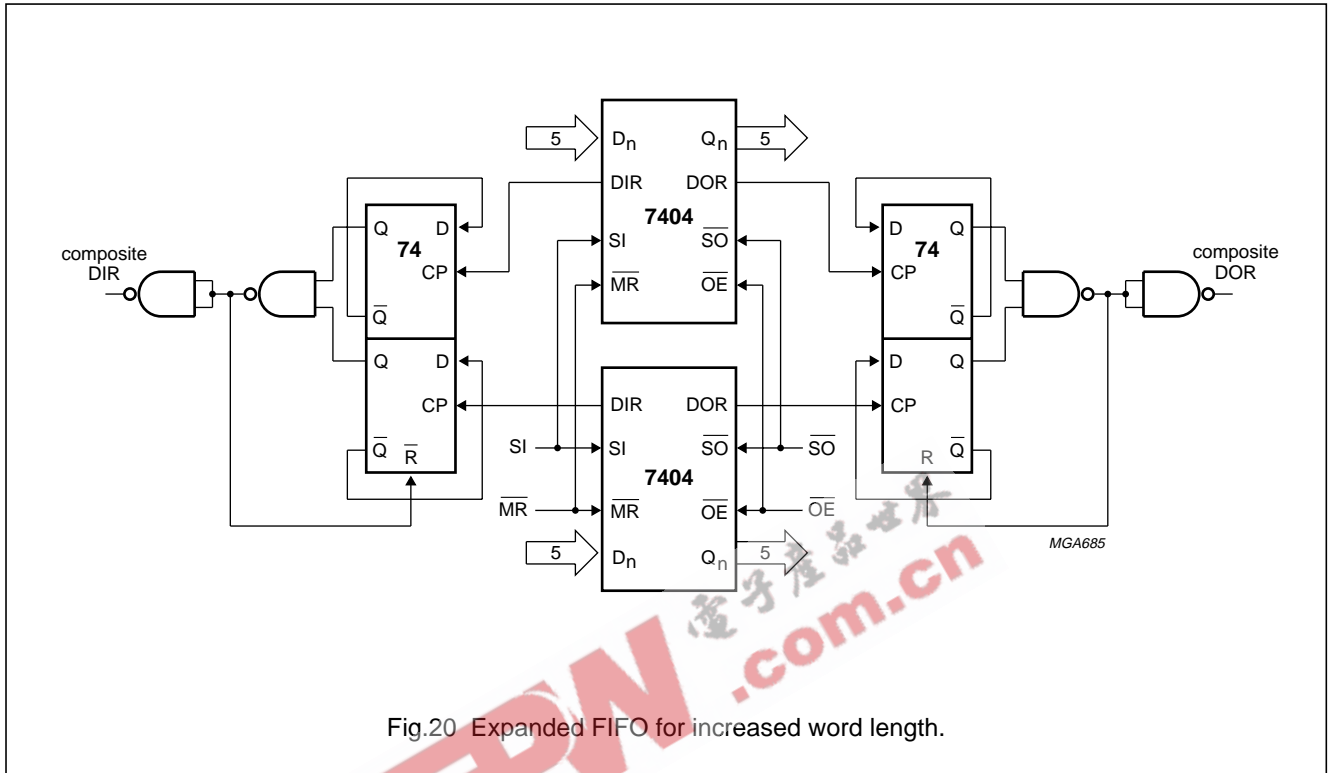

Fig.20 Expanded FIFO for increased word length.

Note to Fig.20

This circuit is only required if the SI input is constantly held HIGH, when the FIFO is empty and the automatic shift-in cycles are started or if \overline{SO} output is constantly held HIGH, when the FIFO is full and the automatic shift-out cycles are started (see Fig.8 and Fig.10).

Expanded format

Figure 21 shows two cascaded FIFOs providing a capacity of 128 words x 5 bits. Figure 22 shows the signals on the nodes of both FIFOs after the application of a SI pulse, when both FIFOs are initially empty. After a ripple through delay, data arrives at the output of FIFO_A. Due to \overline{SO}_A being HIGH, a DOR_A pulse is generated. The requirements of SI_B and D_{nB} are satisfied by the DOR_A pulse width and the timing between the rising edge of DOR_A and Q_{nA}. After a second ripple through delay, data arrives at the output of FIFO_B.

Figure 23 shows the signals on the nodes of both FIFOs after the application of a \overline{SO}_B pulse, when both FIFOs are initially full. After a bubble-up delay a DIR_B pulse is generated, which acts as a \overline{SO}_A pulse for FIFO_A. One word is transferred from the output of FIFO_A to the input of FIFO_B. The requirements of the \overline{SO}_A pulse for FIFO_A is satisfied by the pulse width of DOR_B. After a second bubble-up delay an empty space arrives at D_{nA}, at which time DIR_A goes HIGH.

Figure 24 shows the waveforms at all external nodes of both FIFOs during a complete shift-in and shift-out sequence.

5-Bit x 64-word FIFO register; 3-state

74HC/HCT7404

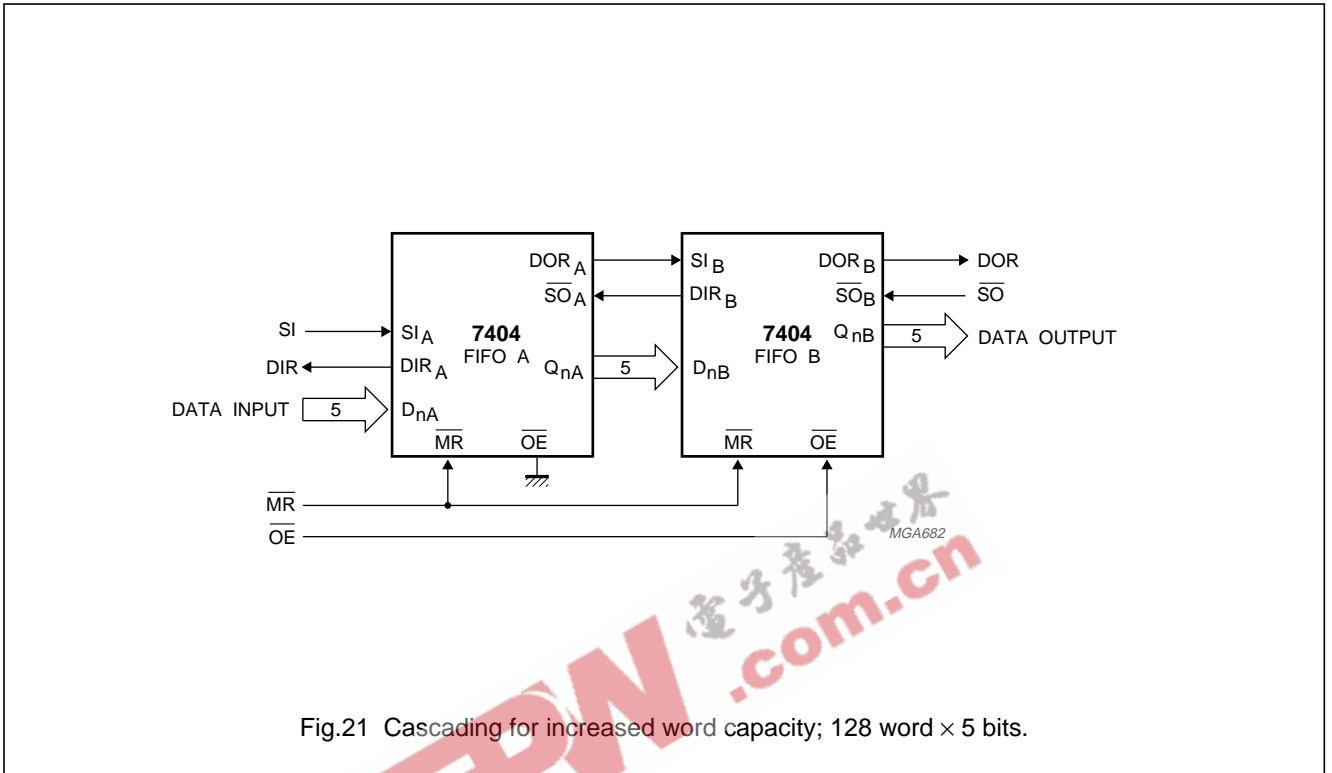

Fig.21 Cascading for increased word capacity; 128 word x 5 bits.

Note to Fig.21

The “7404” is easily cascaded to increase word capacity without any external circuitry. In cascaded format, all necessary communications are handled by the FIFOs. Figures 22 and 23 demonstrate the intercommunication timing between FIFO_A and FIFO_B. Figure 24 provides an overview of pulses and timing of two cascaded FIFOs, when shifted full and shifted empty again.

5-Bit x 64-word FIFO register; 3-state

74HC/HCT7404

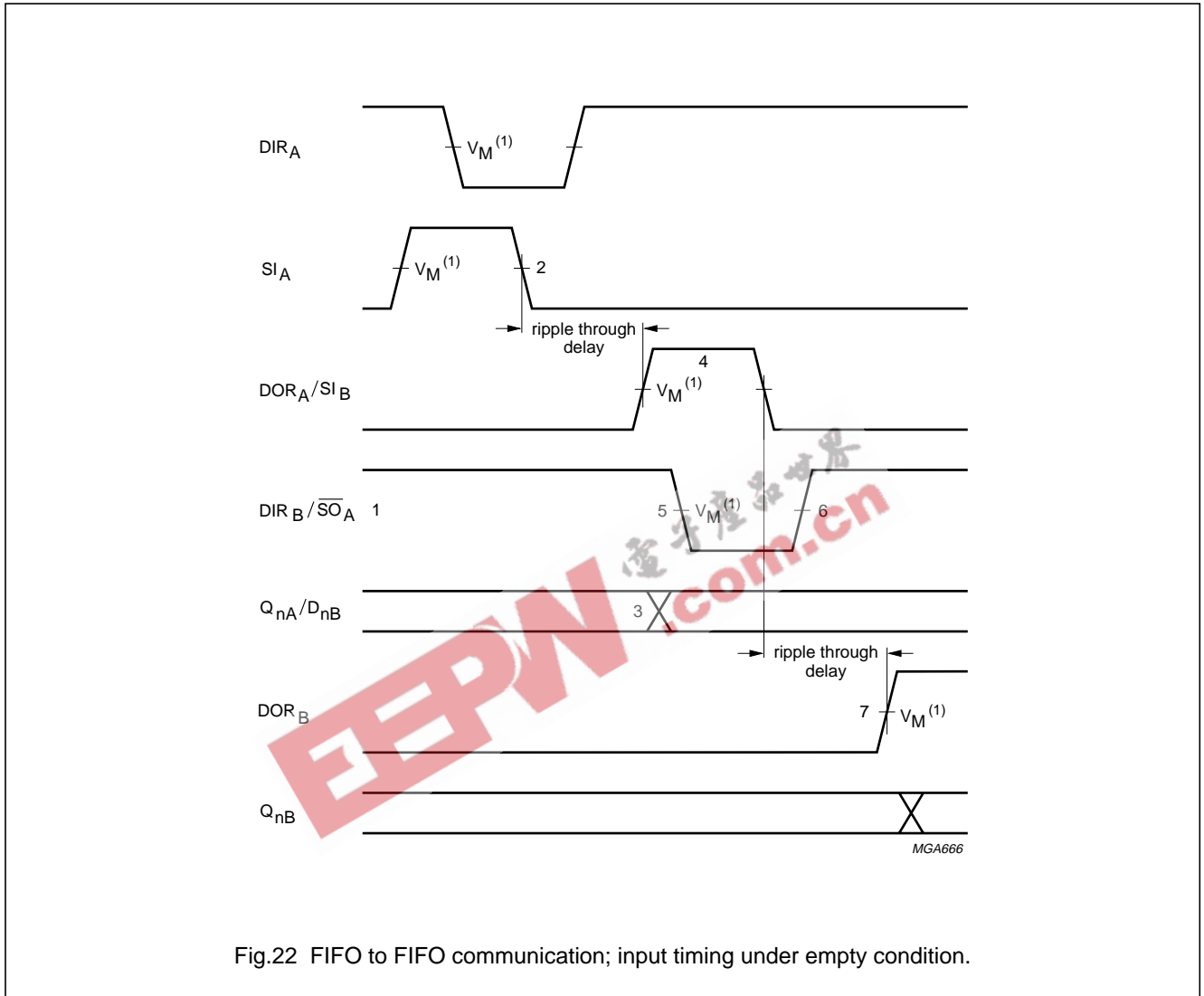

Fig.22 FIFO to FIFO communication; input timing under empty condition.

Notes to Fig.22

1. FIFO_A and FIFO_B initially empty, \overline{SO}_A held HIGH in anticipation of data
2. Load one word into FIFO_A; SI pulse applied, results in DIR pulse
3. Data-out_A/data-in_B transition; valid data arrives at FIFO_A output stage after a specified delay of the DOR flag, meeting data input set-up requirements of FIFO_B
4. DOR_A and SI_B pulse HIGH; (ripple through delay after SI_A LOW) data is unloaded from FIFO_A as a result of the data output ready pulse, data is shifted into FIFO_B
5. DIR_B and \overline{SO}_A go LOW; flag indicates input stage of FIFO_B is busy, shift-out of FIFO_A is complete
6. DIR_B and \overline{SO}_A go HIGH automatically; the input stage of FIFO_B is again able to receive data, \overline{SO} is held HIGH in anticipation of additional data
7. DOR_B goes HIGH; (ripple through delay after SI_B LOW) valid data is present one propagation delay later at the FIFO_B output stage.

5-Bit x 64-word FIFO register; 3-state

74HC/HCT7404

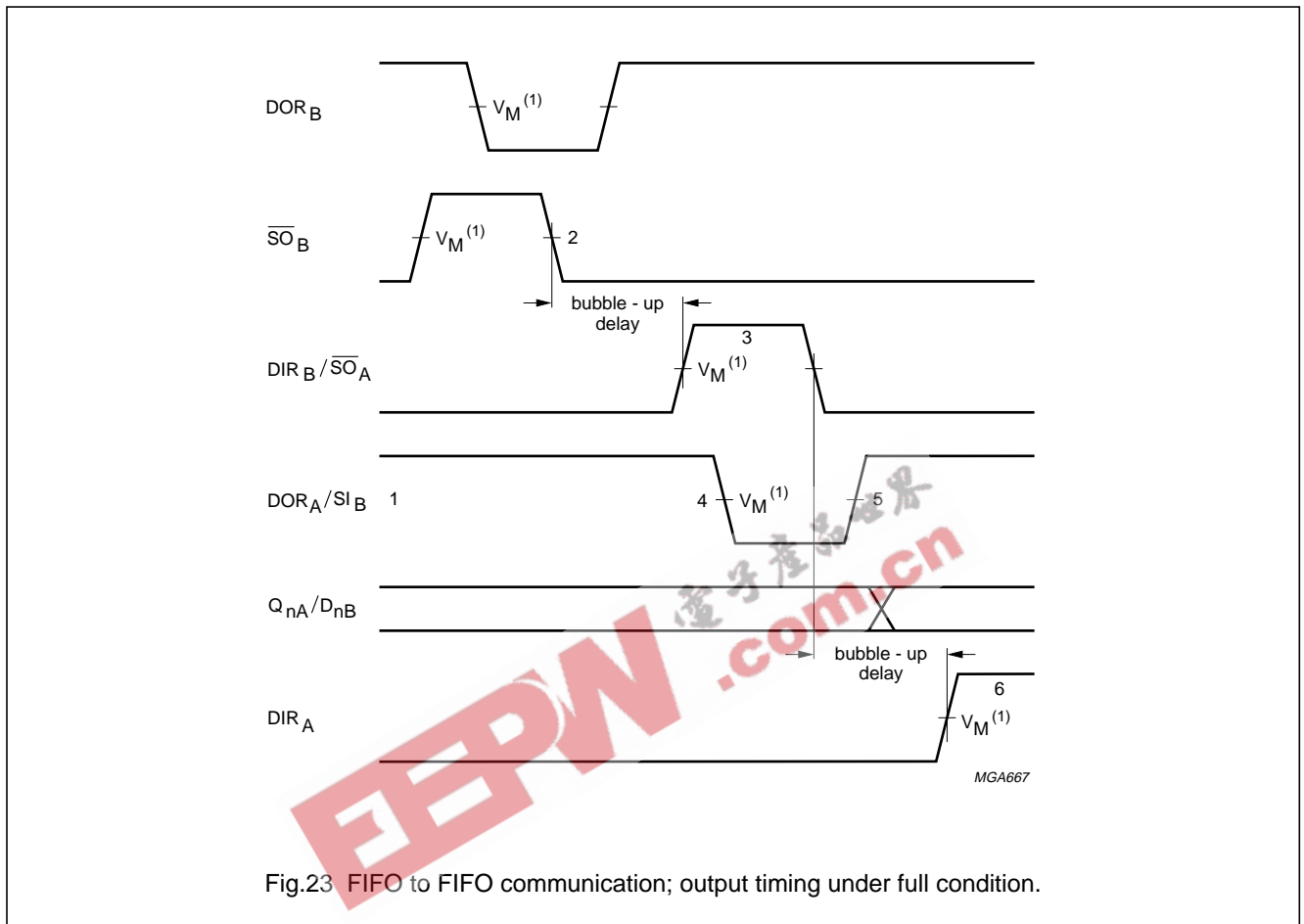

Fig.23 FIFO to FIFO communication; output timing under full condition.

Notes to Fig.23

1. FIFO_A and FIFO_B initially full, SI_B held HIGH in anticipation of shifting in new data as an empty location bubbles-up
2. Unload one word from FIFO_B; \overline{S}_O pulse applied, results in DOR pulse
3. DIR_B and \overline{S}_O_A pulse HIGH; (bubble-up delay after \overline{S}_O_B LOW) data is loaded into FIFO_B as a result of the DIR pulse, data is shifted out of FIFO_A
4. DOR_A and SI_B go LOW; flag indicates the output stage of FIFO_A is busy, shift-in to FIFO_B is complete
5. DOR_A and SI_B go HIGH; flag indicates valid data is again available at FIFO_A output stage, SI_B is held HIGH, awaiting bubble-up of empty location
6. DIR_A goes HIGH; (bubble-up delay after \overline{S}_O_A LOW) an empty location is present at input stage of FIFO_A.

5-Bit x 64-word FIFO register; 3-state

74HC/HCT7404

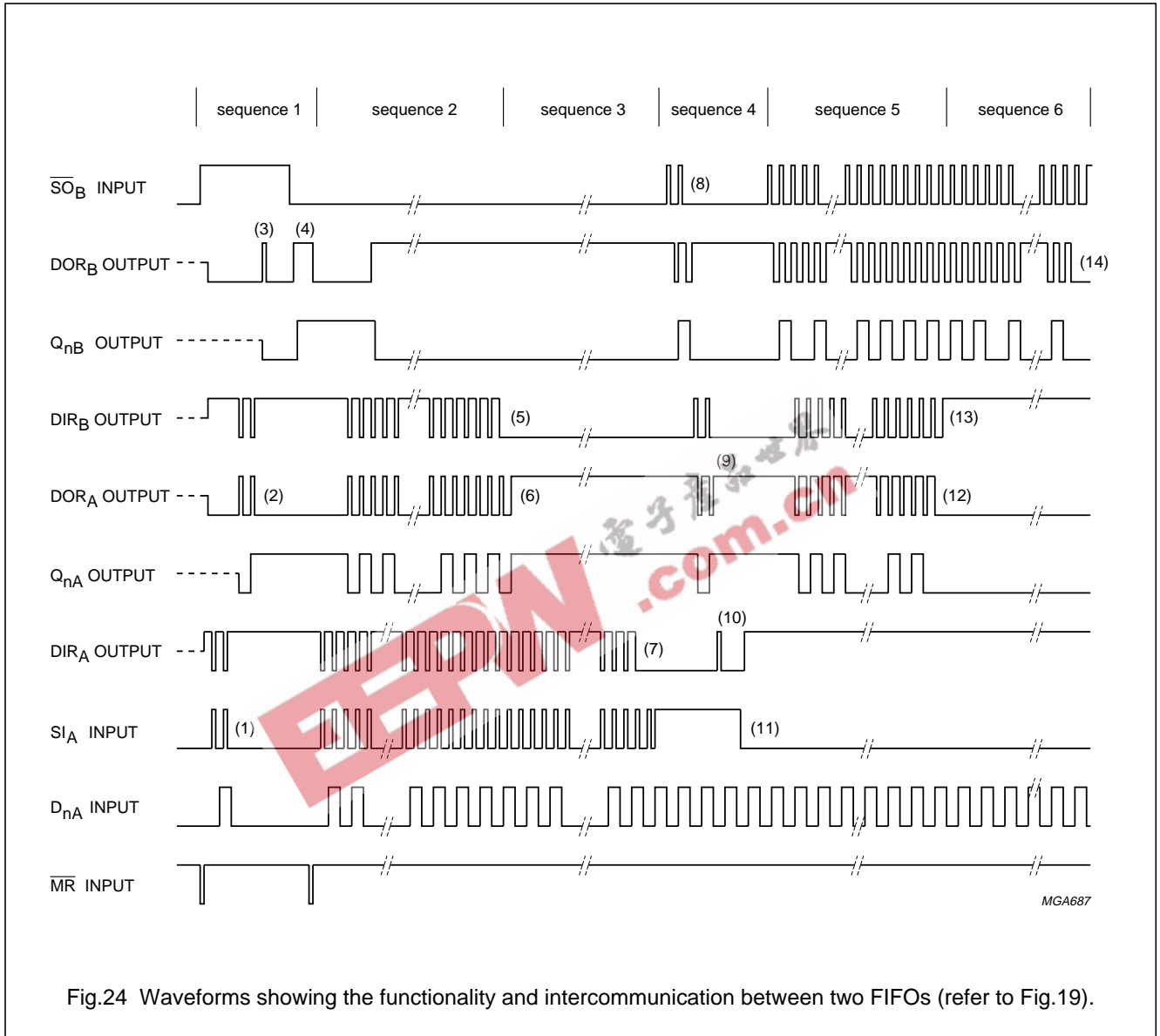

Fig.24 Waveforms showing the functionality and intercommunication between two FIFOs (refer to Fig.19).

Note to Fig.24

Sequence 1 (both FIFOs empty, starting SHIFT-IN process)

After a \overline{M}_R pulse has been applied $FIFO_A$ and $FIFO_B$ are empty. The DOR flags of $FIFO_A$ and $FIFO_B$ go LOW due to no valid data being present at the outputs. The DIR flags are set HIGH due to the FIFOs being ready to accept data. \overline{S}_O_B is held HIGH and two S_{I_A} pulses are applied (1). These pulses allow two data words to ripple through to the output stage of $FIFO_A$ and to the input stage of $FIFO_B$ (2). When data arrives at the output of $FIFO_B$, a DOR_B pulse is generated (3). When \overline{S}_O_B goes LOW, the first bit is shifted out and a second bit ripples through to the output after which DOR_B goes HIGH (4).

5-Bit x 64-word FIFO register; 3-state

74HC/HCT7404

Sequence 2 (FIFO_B runs full)

After the \overline{MR} pulse, a series of 64 SI pulses are applied. When 64 words are shifted in, DIR_B remains LOW due to FIFO_B being full (5). DOR_A goes LOW due to FIFO_A being empty.

Sequence 3 (FIFO_A runs full)

When 65 words are shifted in, DOR_A remains HIGH due to valid data remaining at the output of FIFO_A. Q_{nA} remains HIGH, being the polarity of the 65th data word (6). After the 128th SI pulse, DIR remains LOW and both FIFOs are full (7). Additional pulses have no effect.

Sequence 4 (both FIFOs full, starting SHIFT-OUT process)

SI_A is held HIGH and two \overline{SO}_B pulses are applied (8). These pulses shift out two words and thus allow two empty locations to bubble-up to the input stage of FIFO_B, and proceed to FIFO_A (9). When the first empty location arrives at the input of FIFO_A, a DIR_A pulse is generated (10) and a new word is shifted into FIFO_A. SI_A is made LOW and now the second empty location reaches the input stage of FIFO_A, after which DIR_A remains HIGH (11).

Sequence 5 (FIFO_A runs empty)

At the start of sequence 5 FIFO_A contains 63 valid words due to two words being shifted out and one word being shifted in, in sequence 4. An additional series of \overline{SO}_B pulses are applied. After 63 \overline{SO}_B pulses, all words from FIFO_A are shifted into FIFO_B. DOR_A remains LOW (12).

Sequence 6 (FIFO_B runs empty)

After the next \overline{SO}_B pulse, DIR_B remains HIGH due to the input stage of FIFO_B being empty. After another 63 \overline{SO}_B pulses, DOR_B remains LOW due to both FIFOs being empty (14). Additional \overline{SO}_B pulses have no effect. The last word remains available at the output Q_n.

PACKAGE OUTLINES

See "74HC/HCT/HCU/HCMOS Logic Package Outlines".