

74F579 8-Bit Bidirectional Binary Counter with 3-STATE Outputs

General Description

The 74F579 is a fully synchronous 8-stage up/down counter with multiplexed 3-STATE I/O ports for bus-oriented applications. It features a preset capability for programmable operation, carry lookahead for easy cascading and a U/\bar{D} input to control the direction of counting. All state changes, whether in counting or parallel loading, are initiated by the rising edge of the clock.

Features

- Multiplexed 3-STATE I/O ports
- Built-in lookahead carry capability
- Count frequency 100 MHz typical
- Supply current 75 mA typical
- Guaranteed 4000V minimum ESD protection

Ordering Code:

Order Number	Package Number	Package Description
74F579SC	M20B	20-Lead Small Outline Integrated Circuit (SOIC), JEDEC MS-013, 0.300 Wide
74F579SJ	M20D	20-Lead Small Outline Package (SOP), EIAJ TYPE II, 5.3mm Wide
74F579PC	N20A	20-Lead Plastic Dual-In-Line Package (PDIP), JEDEC MS-001, 0.300 Wide

Devices also available in Tape and Reel. Specify by appending the suffix letter "X" to the ordering code.

Logic Symbol

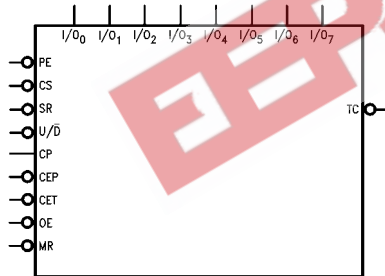

Connection Diagram

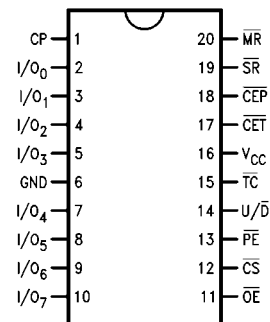

Unit Loading/Fan Out

Pin Names	Description	U.L.	
		HIGH/LOW	Input I_{IH}/I_{IL} Output I_{OH}/I_{OL}
I/O_0 – I/O_7	Data Inputs or 3-STATE Outputs	3.5/0.333 75/15	70 μ A/–0.2 mA –3 mA/24 mA
\overline{PE}	Parallel Enable Input (Active LOW)	0.25/0.333	5 μ A/–0.2 mA
U/\overline{D}	Up-Down Count Control Input	0.25/0.333	5 μ A/–0.2 mA
\overline{MR}	Master Reset Input (Active LOW)	0.25/0.333	5 μ A/–0.2 mA
\overline{SR}	Synchronous Reset Input (Active LOW)	0.25/0.333	5 μ A/–0.2 mA
\overline{CEP}	Count Enable Parallel Input (Active LOW)	0.25/0.333	5 μ A/–0.2 mA
\overline{CET}	Count Enable Trickle Input (Active LOW)	0.25/0.333	5 μ A/–0.2 mA
\overline{CS}	Chip Select Input Active (Active LOW)	0.25/0.333	5 μ A/–0.2 mA
\overline{OE}	Output Enable Input (Active LOW)	0.25/0.333	5 μ A/–0.2 mA
CP	Clock Pulse Input (Active Rising Edge)	0.25/0.333	5 μ A/–0.2 mA
\overline{TC}	Terminal Count Output (Active LOW)	25/12.5	–1 mA/5 mA

Function Table

\overline{MR}	\overline{SR}	\overline{CS}	\overline{PE}	\overline{CEP}	\overline{CET}	U/\overline{D}	\overline{OE}	CP	Function
X	X	H	X	X	X	X	X	X	I/O_a to I/O_n in High Z (\overline{PE} Disabled)
X	X	L	H	X	X	X	H	X	I/O_a to I/O_n in High Z
X	X	L	H	X	X	X	L	X	Flip-Flop Outputs Appear on I/O Lines
L	X	X	X	X	X	X	X	X	Asynchronous Reset for all Flip-Flops
H	L	X	X	X	X	X	X	\nearrow	Synchronous Reset for all Flip-Flops
H	H	L	L	X	X	X	X	\nearrow	Parallel Load all Flip-Flops
H	H	(Not LL)	H	X	X	X	X	\nearrow	Hold
H	H	(Not LL)	X	H	X	X	X	\nearrow	Hold (\overline{TC} Held HIGH)
H	H	(Not LL)	L	L	H	X	X	\nearrow	Count Up
H	H	(Not LL)	L	L	L	X	X	\nearrow	Count Down

H = HIGH Voltage Level

L = LOW Voltage Level

X = Immaterial

 \nearrow = LOW to HIGH Clock TransitionNot LL = \overline{CS} and \overline{PE} should never both be LOW voltage level at the same time.

Logic Diagrams

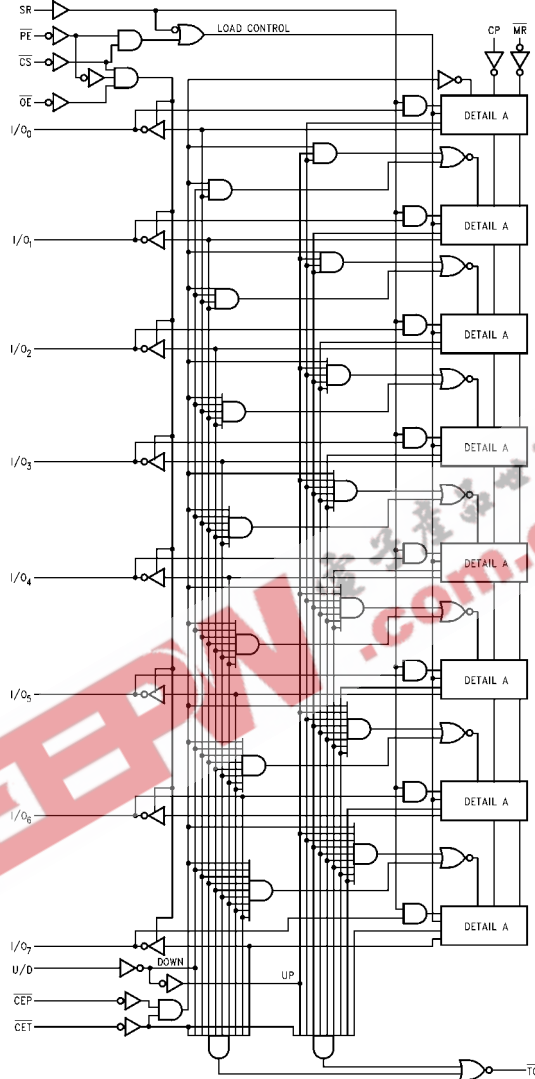

Please note that this diagram is provided only for the understanding of logic operations and should not be used to estimate propagation delays.

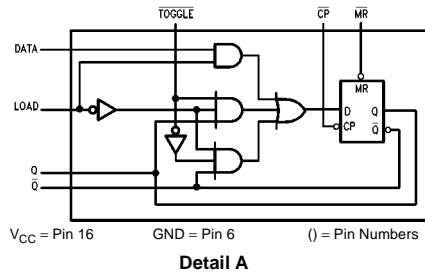

Absolute Maximum Ratings (Note 1)

Storage Temperature	-65°C to +150°C
Ambient Temperature under Bias	-55°C to +125°C
Junction Temperature under Bias	-55°C to +150°C
V _{CC} Pin Potential to Ground Pin	-0.5V to +7.0V
Input Voltage (Note 2)	-0.5V to +7.0V
Input Current (Note 2)	-30 mA to +5.0 mA
Voltage Applied to Output in HIGH State (with V _{CC} = 0V)	
Standard Output	-0.5V to V _{CC}
3-STATE Output	-0.5V to +5.5V
Current Applied to Output in LOW State (Max)	twice the rated I _{OL} (mA)
ESD Last Passing Voltage (Min)	4000V

Recommended Operating Conditions

Free Air Ambient Temperature	0°C to +70°C
Supply Voltage	+4.5V to +5.5V

Note 1: Absolute maximum ratings are values beyond which the device may be damaged or have its useful life impaired. Functional operation under these conditions is not implied.

Note 2: Either voltage limit or current limit is sufficient to protect inputs.

DC Electrical Characteristics

Symbol	Parameter	Min	Typ	Max	Units	V _{CC}	Conditions
V _{IH}	Input HIGH Voltage	2.0			V		Recognized as a HIGH Signal
V _{IL}	Input LOW Voltage			0.8	V		Recognized as a LOW Signal
V _{CD}	Input Clamp Diode Voltage			-1.2	V	Min	I _{IN} = -18 mA
V _{OH}	Output HIGH Voltage	10% V _{CC} 5% V _{CC}	2.4 2.7		V	Min	I _{OH} = -3 mA
V _{OL}	Output LOW Voltage	10% V _{CC} 5% V _{CC}		0.5 0.5	V	Min	I _{OL} = 20 mA (TC), I _{OL} = 24 mA (I/O _n) I _{OL} = 20 mA (TC), I _{OL} = 24 mA (I/O _n)
I _{IH}	Input HIGH Current			5.0	μA	Max	V _{IN} = 2.7V (Non-I/O Pins)
I _{BVI}	Input HIGH Current Breakdown Test			7.0	μA	Max	V _{IN} = 7.0V (Non-I/O Pins)
I _{BVIT}	Input HIGH Current Breakdown (I/O)			0.5	mA	Max	V _{IN} = 5.5V (I/O _n)
I _{CEX}	Output HIGH Leakage Current			50	μA	Max	V _{OUT} = V _{CC}
V _{ID}	Input Leakage Test	4.75			V	0.0	I _{ID} = 1.9 μA All Other Pins Grounded
I _{OD}	Output Leakage Circuit Control			3.75	μA	0.0	V _{IOD} = 150 mV All Other Pins Grounded
I _{ZZ}	Bus Drainage Test			500	μA	0.0	V _{OUT} = 5.25V
I _{IL}	Input LOW Current			-0.2	mA	Max	V _{IN} = 0.5V (Non-I/O Pins)
I _{IH} & I _{OZH}	Output Leakage Current			70	μA	Max	V _{OUT} = 2.7V (I/O _n)
I _{IL} & I _{OZL}	Output Leakage Current			-200	μA	Max	V _{OUT} = 0.5V (I/O _n)
I _{OS}	Output Short-Circuit Current	-60		-150	mA	Max	V _{OUT} = 0V
I _{CCH}	Power Supply Current		70	110	mA	Max	V _O = HIGH
I _{CCL}	Power Supply Current		85	120	mA	Max	V _O = LOW
I _{CCZ}	Power Supply Current		85	125	mA	Max	V _O = HIGH Z

AC Electrical Characteristics							
Symbol	Parameter	T _A = +25°C V _{CC} = +5.0V C _L = 50 pF			T _A = 0°C to +70°C V _{CC} = +5.0V C _L = 50 pF		Units
		Min	Typ	Max	Min	Max	
f _{MAX}	Maximum Clock Frequency	70	85		80		
t _{PLH}	Propagation Delay	3.0	5.0	7.5	3.0	8.0	ns
t _{PHL}	CP to I/O _n	5.0	8.0	11.5	5.0	11.5	
t _{PLH}	Propagation Delay	5.0	7.5	11.5	5.0	12.0	ns
t _{PHL}	CP to \overline{TC}	5.0	7.0	11.5	5.0	12.0	
t _{PLH}	Propagation Delay	4.5	7.0	9.0	4.5	10.0	ns
t _{PHL}	U/ \overline{D} to \overline{TC}	4.5	8.0	9.5	4.5	10.0	
t _{PLH}	Propagation Delay	2.5	3.8	6.0	2.5	6.5	ns
t _{PHL}	\overline{CEP} or \overline{CET} to \overline{TC}	3.5	6.0	8.0	3.5	8.5	
t _{PHL}	Propagation Delay	5.0	7.5	10.0	5.0	10.0	ns
t _{PHL}	Propagation Delay	6.5	10.0	13.0	6.5	13.5	ns
t _{PZH}	Output Enable Time	3.0	5.0	8.5	3.0	9.0	ns
t _{PZL}	\overline{CS} or \overline{PE} to I/O	5.5	8.0	10.5	5.5	11.5	
t _{PHZ}	Output Disable Time	2.0	5.0	8.5	2.0	9.0	ns
t _{PLZ}	\overline{CS} or \overline{PE} to I/O	2.0	4.5	8.0	2.0	8.5	
t _{PZH}	Output Enable Time	3.0	5.0	8.0	3.0	8.5	ns
t _{PZL}	\overline{OE} to I/O _n	5.0	8.0	11.0	5.0	12.0	
t _{PHZ}	Output Disable Time	2.0	4.0	6.5	2.0	6.5	ns
t _{PLZ}	\overline{OE} to I/O _n	2.0	4.0	6.0	2.0	6.5	
AC Operating Requirements							
Symbol	Parameter	T _A = +25°C V _{CC} = +5.0V			T _A = 0°C to +70°C V _{CC} = +5.0V		Units
		Min	Typ	Max	Min	Max	
t _{S(H)}	Setup Time	4.0			4.0		ns
t _{S(L)}	I/O _n to CP	4.0			4.0		
t _{H(H)}	Hold Time	0.0			0.0		ns
t _{H(L)}	I/O _n to CP	0.0			0.0		
t _{S(H)}	Setup Time	9.5			9.5		ns
t _{S(L)}	\overline{PE} , \overline{CS} or \overline{SR} to CP	9.5			9.5		
t _{H(H)}	Hold Time	0.0			0.0		ns
t _{H(L)}	\overline{PE} , \overline{CS} or \overline{SR} to CP	0.0			0.0		
t _{S(H)}	Setup Time	6.5			6.5		ns
t _{S(L)}	\overline{CET} or \overline{CEP} to CP	9.5			9.5		
t _{H(H)}	Hold Time	0.0			0.0		ns
t _{H(L)}	\overline{CET} or \overline{CEP} to CP	0.0			0.0		
t _{S(H)}	Setup Time	9.0			9.5		ns
t _{S(L)}	U/ \overline{D} to CP	9.0			9.5		
t _{H(H)}	Hold Time	0.0			0.0		ns
t _{H(L)}	U/ \overline{D} to CP	0.0			0.0		
t _{W(H)}	Clock Pulse Width	4.5			4.5		ns
t _{W(L)}	HIGH or LOW	4.5			4.5		
t _{W(L)}	\overline{MR} Pulse Width	3.0			3.0		ns
t _{REC}	Recovery Time	4.0			4.0		ns
	\overline{MR} to CP						

Physical Dimensions inches (millimeters) unless otherwise noted

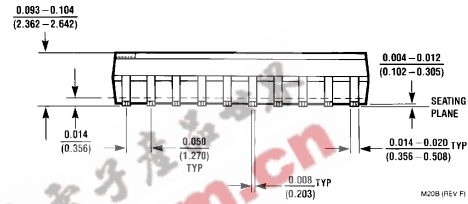
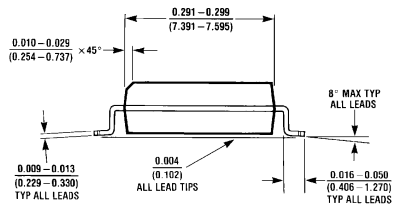
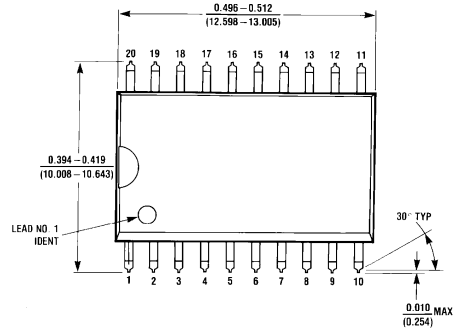

**20-Lead Small Outline Integrated Circuit (SOIC), JEDEC MS-013, 0.300 Wide
Package Number M20B**

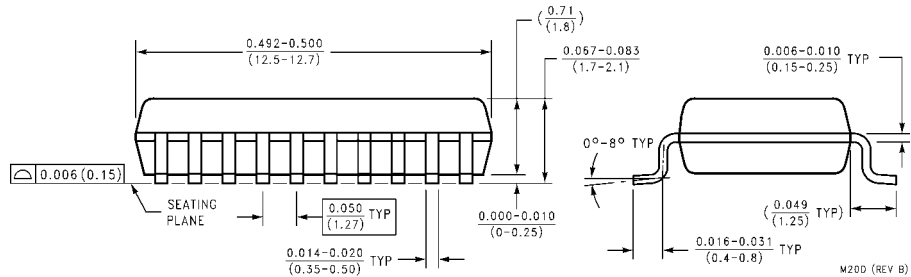
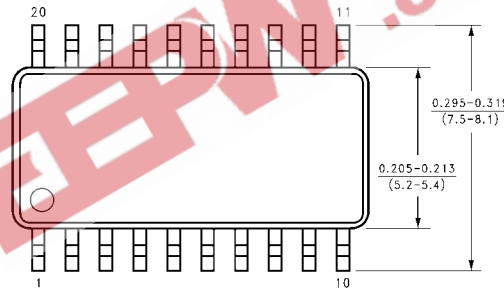

**20-Lead Small Outline Package (SOP), EIAJ TYPE II, 5.3mm Wide
Package Number M20D**

