

## 74VCXR162601

### Low Voltage 18-Bit Universal Bus Transceivers with 3.6V Tolerant Inputs and Outputs and 26Ω Series Resistors in the Outputs

#### General Description

The VCXR162601, 18-bit universal bus transceiver, combines D-type latches and D-type flip-flops to allow data flow in transparent, latched, and clocked modes.

Data flow in each direction is controlled by output-enable ( $\overline{OEAB}$  and  $\overline{OEBA}$ ), latch-enable (LEAB and LEBA), and clock (CLKAB and CLKBA) inputs. The clock can be controlled by the clock-enable (CLKENAB and CLKENBA) inputs. For A-to-B data flow, the device operates in the transparent mode when LEAB is HIGH. When LEAB is LOW, the A data is latched if CLKAB is held at a HIGH-to-LOW logic level. If LEAB is LOW, the A bus data is stored in the latch/flip-flop on the LOW-to-HIGH transition of CLKAB. Output-enable  $\overline{OEAB}$  is active-LOW. When  $\overline{OEAB}$  is HIGH, the outputs are in the high-impedance state.

Data flow for B to A is similar to that of A to B but uses  $\overline{OEBA}$ , LEBA, CLKBA and CLKENBA.

The 74VCXR162601 is designed for low voltage (1.65V to 3.6V)  $V_{CC}$  applications with I/O compatibility up to 3.6V. The VCXR162601 is also designed with 26Ω series resistors on both the A and B Port outputs. This design reduces line noise in applications such as memory address drivers, clock drivers, and bus transceivers/transmitters.

#### Features

- 1.65–3.6V  $V_{CC}$  supply operation
- 3.6V tolerant inputs and outputs
- 26Ω series resistors on both the A and B Port outputs.
- $t_{PD}$  (A to B, B to A)
  - 3.8 ns max for 3.0V to 3.6V  $V_{CC}$
  - 4.6 ns max for 2.3V to 2.7V  $V_{CC}$
  - 9.2 ns max for 1.65V to 1.95V  $V_{CC}$
- Power-down HIGH impedance inputs and outputs
- Supports live insertion/withdrawal (Note 1)
- Static Drive ( $I_{OH}/I_{OL}$ )
  - ±12 mA @ 3.0V  $V_{CC}$
  - ±8 mA @ 2.3V  $V_{CC}$
  - ±3 mA @ 1.65V  $V_{CC}$
- Uses patented noise/EMI reduction circuitry
- Latchup performance exceeds 300 mA
- ESD performance:
  - Human body model > 2000V
  - Machine model >200V

**Note 1:** To ensure the high-impedance state during power up or power down,  $\overline{OE}$  should be tied to  $V_{CC}$  through a pull-up resistor; the minimum value of the resistor is determined by the current-sourcing capability of the driver.

#### Ordering Code:

Order Number	Package Number	Package Description
74VCXR162601MTD	MTD56	56-Lead Thin Shrink Small Outline Package (TSSOP), JEDEC MO-153, 6.1mm Wide

Devices also available in Tape and Reel. Specify by appending the suffix letter "X" to the ordering code.

74VCXR162601 Low Voltage 18-Bit Universal Bus Transceivers with 3.6V Tolerant Inputs and Outputs and 26Ω Series Resistors in the Outputs

### Connection Diagram

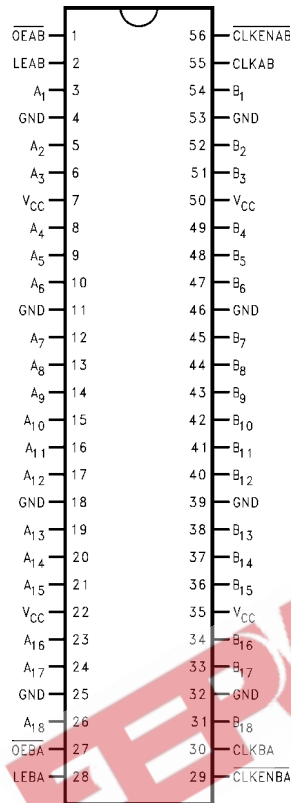

### Pin Descriptions

Pin Names	Description
$\overline{OEAB}$ , $\overline{OEBA}$	Output Enable Inputs (Active LOW)
LEAB, LEBA	Latch Enable Inputs
CLKAB, CLKBA	Clock Inputs
$\overline{CLKENAB}$ , $\overline{CLKENBA}$	Clock Enable Inputs
$A_1$ - $A_{18}$	Side A Inputs or 3-STATE Outputs
$B_1$ - $B_{18}$	Side B Inputs or 3-STATE Outputs

### Function Table (Note 2)

Inputs					Outputs
$\overline{CLKENAB}$	$\overline{OEAB}$	LEAB	CLKAB	$A_n$	$B_n$
X	H	X	X	X	Z
X	L	H	X	L	L
X	L	H	X	H	H
H	L	L	X	X	$B_0$ (Note 3)
H	L	L	X	X	$B_0$ (Note 3)
L	L	L	$\uparrow$	L	L
L	L	L	$\uparrow$	H	H
L	L	L	L	X	$B_0$ (Note 3)
L	L	L	H	X	$B_0$ (Note 4)

H = HIGH Voltage Level  
 L = LOW Voltage Level  
 X = Immaterial (HIGH or LOW, inputs may not float)  
 Z = HIGH Impedance

**Note 2:** A-to-B data flow is shown; B-to-A flow is similar but uses  $\overline{OEBA}$ , LEBA, CLKBA, and  $\overline{CLKENBA}$ .

**Note 3:** Output level before the indicated steady-state input conditions were established

**Note 4:** Output level before the indicated steady-state input conditions were established, provided that CLKAB was HIGH before LEAB went LOW.

### Logic Diagram

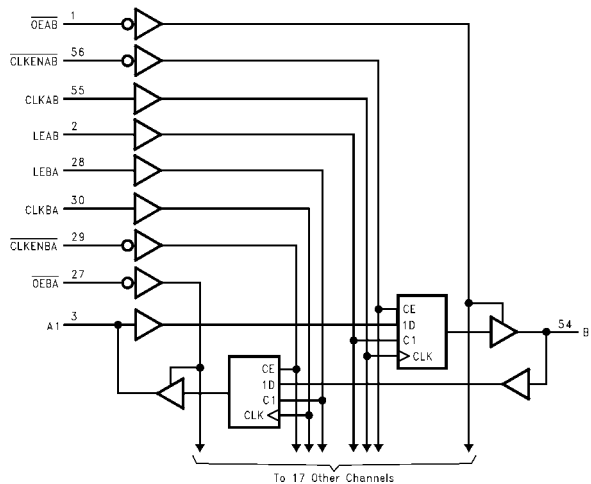

**Absolute Maximum Ratings** (Note 5)

Supply Voltage ( $V_{CC}$ )	-0.5V to +4.6V
DC Input Voltage ( $V_I$ )	-0.5V to +4.6V
Output Voltage ( $V_O$ )	
Outputs 3-STATE	-0.5V to +4.6V
Outputs Active (Note 6)	-0.5 to $V_{CC} + 0.5V$
DC Input Diode Current ( $I_{IK}$ ) $V_I < 0V$	-50 mA
DC Output Diode Current ( $I_{OK}$ )	
$V_O < 0V$	-50 mA
$V_O > V_{CC}$	+50 mA
DC Output Source/Sink Current ( $I_{OH}/I_{OL}$ )	$\pm 50$ mA
DC $V_{CC}$ or Ground Current per Supply Pin ( $I_{CC}$ or Ground)	$\pm 100$ mA
Storage Temperature Range ( $T_{STG}$ )	-65°C to +150°C

**Recommended Operating Conditions** (Note 7)

Power Supply	
Operating	1.65V to 3.6V
Data Retention Only	1.2V to 3.6V
Input Voltage	-0.3V to 3.6V
Output Voltage ( $V_O$ )	
Output in Active States	0V to $V_{CC}$
Output in 3-STATE	0.0V to 3.6V
Output Current in $I_{OH}/I_{OL}$	
$V_{CC} = 3.0V$ to 3.6V	$\pm 12$ mA
$V_{CC} = 2.3V$ to 2.7V	$\pm 8$ mA
$V_{CC} = 1.65V$ to 2.3V	$\pm 3$ mA
Free Air Operating Temperature ( $T_A$ )	-40°C to +85°C
Minimum Input Edge Rate ( $\Delta t/\Delta V$ )	
$V_{IN} = 0.8V$ to 2.0V, $V_{CC} = 3.0V$	10 ns/V

**Note 5:** The "Absolute Maximum Ratings" are those values beyond which the safety of the device cannot be guaranteed. The device should not be operated at these limits. The parametric values defined in the Electrical Characteristics tables are not guaranteed at the Absolute Maximum Ratings. The Recommended Operating Conditions tables will define the conditions for actual device operation.

**Note 6:**  $I_{OK}$  Absolute Maximum Rating must be observed.

**Note 7:** Floating or unused pin (inputs or I/O's) must be held HIGH or LOW.

**DC Electrical Characteristics (2.7V <  $V_{CC}$  ≤ 3.6V)**

Symbol	Parameter	Conditions	$V_{CC}$ (V)	Min	Max	Units
$V_{IH}$	HIGH Level Input Voltage		2.7-3.6	2.0		V
$V_{IL}$	LOW Level Input Voltage		2.7-3.6		0.8	V
$V_{OH}$	HIGH Level Output Voltage	$I_{OH} = -100 \mu A$ $I_{OH} = -6 \text{ mA}$ $I_{OH} = -8 \text{ mA}$ $I_{OH} = -12 \text{ mA}$	2.7-3.6 2.7 3.0 3.0	$V_{CC} - 0.2$ 2.2 2.4 2.2		V
$V_{OL}$	LOW Level Output Voltage	$I_{OL} = 100 \mu A$ $I_{OL} = 6 \text{ mA}$ $I_{OL} = 8 \text{ mA}$ $I_{OL} = 12 \text{ mA}$	2.7-3.6 2.7 3.0 3.0		0.2 0.4 0.55 0.8	V
$I_I$	Input Leakage Current	$0V \leq V_I \leq 3.6V$	2.7-3.6		$\pm 5.0$	$\mu A$
$I_{OZ}$	3-STATE Output Leakage	$0V \leq V_O \leq 3.6V$ $V_I = V_{IH}$ or $V_{IL}$	2.7-3.6		$\pm 10$	$\mu A$
$I_{OFF}$	Power Off Leakage Current	$0V \leq (V_I, V_O) \leq 3.6V$	0		10	$\mu A$
$I_{CC}$	Quiescent Supply Current	$V_I = V_{CC}$ or GND $V_{CC} \leq (V_I, V_O) \leq 3.6V$ (Note 8)	2.7-3.6 2.7-3.6		20 $\pm 20$	$\mu A$
$\Delta I_{CC}$	Increase in $I_{CC}$ per Input	$V_{IH} = V_{CC} - 0.6V$	2.7-3.6		750	$\mu A$

**Note 8:** Outputs disabled or 3-STATE only.

### DC Electrical Characteristics ( $2.3V \leq V_{CC} \leq 2.7V$ )

Symbol	Parameter	Conditions	$V_{CC}$ (V)	Min	Max	Units
$V_{IH}$	HIGH Level Input Voltage		2.3-2.7	1.6		V
$V_{IL}$	LOW Level Input Voltage		2.3-2.7		0.7	V
$V_{OH}$	HIGH Level Output Voltage	$I_{OH} = -100 \mu A$ $I_{OH} = -4 \text{ mA}$ $I_{OH} = -6 \text{ mA}$ $I_{OH} = -8 \text{ mA}$	2.3-2.7 2.3 2.3 2.3	$V_{CC} - 0.2$ 2.0 1.8 1.7		V
$V_{OL}$	LOW Level Output Voltage	$I_{OL} = 100 \mu A$ $I_{OL} = 6 \text{ mA}$ $I_{OL} = 8 \text{ mA}$	2.3-2.7 2.3 2.3		0.2 0.4 0.6	V
$I_I$	Input Leakage Current	$0 \leq V_I \leq 3.6V$	2.3-2.7		$\pm 5.0$	$\mu A$
$I_{OZ}$	3-STATE Output Leakage	$0 \leq V_O \leq 3.6V$ $V_I = V_{IH}$ or $V_{IL}$	2.3-2.7		$\pm 10$	$\mu A$
$I_{OFF}$	Power Off Leakage Current	$0 \leq (V_I, V_O) \leq 3.6V$	0		10	$\mu A$
$I_{CC}$	Quiescent Supply Current	$V_I = V_{CC}$ or GND $V_{CC} \leq (V_I, V_O) \leq 3.6V$ (Note 9)	2.3-2.7 2.3-2.7		20 $\pm 20$	$\mu A$

Note 9: Outputs disabled or 3-STATE only.

### DC Electrical Characteristics ( $1.65V \leq V_{CC} < 2.3V$ )

Symbol	Parameter	Conditions	$V_{CC}$ (V)	Min	Max	Units
$V_{IH}$	HIGH Level Input Voltage		1.65 - 2.3	$0.65 \times V_{CC}$		V
$V_{IL}$	LOW Level Input Voltage		1.65 - 2.3		$0.35 \times V_{CC}$	V
$V_{OH}$	HIGH Level Output Voltage	$I_{OH} = -100 \mu A$ $I_{OH} = -3 \text{ mA}$	1.65 - 2.3 1.65	$V_{CC} - 0.2$ 1.25		V
$V_{OL}$	LOW Level Output Voltage	$I_{OL} = 100 \mu A$ $I_{OL} = 3 \text{ mA}$	1.65 - 2.3 1.65		0.2 0.3	V
$I_I$	Input Leakage Current	$0 \leq V_I \leq 3.6V$	1.65 - 2.3		$\pm 5.0$	$\mu A$
$I_{OZ}$	3-STATE Output Leakage	$0 \leq V_O \leq 3.6V$ $V_I = V_{IH}$ or $V_{IL}$	1.65 - 2.3		$\pm 10$	$\mu A$
$I_{OFF}$	Power Off Leakage Current	$0 \leq (V_I, V_O) \leq 3.6V$	0		10	$\mu A$
$I_{CC}$	Quiescent Supply Current	$V_I = V_{CC}$ or GND $V_{CC} \leq (V_I, V_O) \leq 3.6V$ (Note 10)	1.65 - 2.3 1.65 - 2.3		20 $\pm 20$	$\mu A$

Note 10: Outputs disabled or 3-STATE only.

AC Electrical Characteristics (Note 11)								
Symbol	Parameter	$T_A = -40^\circ\text{C to } +85^\circ\text{C}, C_L = 30 \text{ pF}, R_L = 500\Omega$						Units
		$V_{CC} = 3.3V \pm 0.3V$		$V_{CC} = 2.5 \pm 0.2V$		$V_{CC} = 1.8V \pm 0.15V$		
		Min	Max	Min	Max	Min	Max	
$f_{MAX}$	Maximum Clock Frequency	250		200		125		MHz
$t_{PHL}, t_{PLH}$	Propagation Delay A to B or B to A	0.6	3.8	0.8	4.6	1.5	9.2	ns
$t_{PHL}, t_{PLH}$	Propagation Delay Clock to A or B	0.6	4.4	0.8	5.5	1.5	9.8	ns
$t_{PHL}, t_{PLH}$	Propagation Delay LEBA or LEAB to A or B	0.6	4.4	0.8	5.8	1.5	9.8	ns
$t_{PZL}, t_{PZH}$	Output Enable Time OEBA or OEAB to A or B	0.6	4.3	0.8	5.9	1.5	9.8	ns
$t_{PLZ}, t_{PHZ}$	Output Disable Time OEBA or OEAB to A or B	0.6	4.3	0.8	4.9	1.5	8.8	ns
$t_S$	Setup Time	1.5		1.5		2.5		ns
$t_H$	Hold Time	1.0		1.0		1.0		ns
$t_W$	Pulse Width	1.5		1.5		4.0		ns
$t_{OSHL}, t_{OSLH}$	Output to Output Skew (Note 12)		0.5		0.5		0.75	ns
<p><b>Note 11:</b> For <math>C_L = 50\text{pF}</math>, add approximately 300ps to the AC maximum specification.</p> <p><b>Note 12:</b> Skew is defined as the absolute value of the difference between the actual propagation delay for any two separate outputs of the same device. The specification applies to any outputs switching in the same direction, either HIGH-to-LOW (<math>t_{OSHL}</math>) or LOW-to-HIGH (<math>t_{OSLH}</math>).</p>								
Dynamic Switching Characteristics								
Symbol	Parameter	Conditions	$V_{CC}$ (V)	$T_A = +25^\circ\text{C}$		Units		
				Typical				
$V_{OLP}$	Quiet Output Dynamic Peak $V_{OL}$	$C_L = 30 \text{ pF}, V_{IH} = V_{CC}, V_{IL} = 0V$	1.8 2.5 3.3	0.15 0.25 0.35		V		
$V_{OLV}$	Quiet Output Dynamic Valley $V_{OL}$	$C_L = 30 \text{ pF}, V_{IH} = V_{CC}, V_{IL} = 0V$	1.8 2.5 3.3	0.15 -0.25 -0.35		V		
$V_{OHV}$	Quiet Output Dynamic Valley $V_{OH}$	$C_L = 30 \text{ pF}, V_{IH} = V_{CC}, V_{IL} = 0V$	1.8 2.5 3.3	1.5 2.05 2.65		V		
Capacitance								
Symbol	Parameter	Conditions	$T_A = +25^\circ\text{C}$		Units			
$C_{IN}$	Input Capacitance	$V_{CC} = 1.8V, 2.5V, \text{ or } 3.3V,$ $V_I = 0V \text{ or } V_{CC}$	6		pF			
$C_{IO}$	Output Capacitance	$V_I = 0V, \text{ or } V_{CC},$ $V_{CC} = 1.8V, 2.5V \text{ or } 3.3V$	7		pF			
$C_{PD}$	Power Dissipation Capacitance	$V_I = 0V \text{ or } V_{CC}, f = 10 \text{ MHz}$ $V_{CC} = 1.8V, 2.5V \text{ or } 3.3V$	20		pF			

## AC Loading and Waveforms

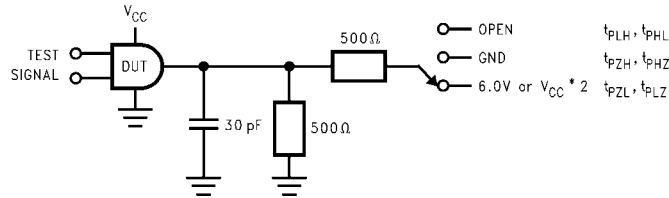

FIGURE 1. AC Test Circuit

TEST	SWITCH
$t_{PLH}$ , $t_{PHL}$	Open
$t_{PZL}$ , $t_{PLZ}$	6V at $V_{CC} = 3.3 \pm 0.3V$ ; $V_{CC} \times 2$ at $V_{CC} = 2.5 \pm 0.2V$ ; $1.8V \pm 0.15V$
$t_{PZH}$ , $t_{PHZ}$	GND

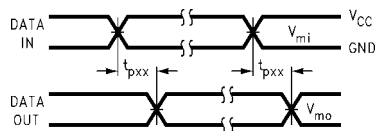

FIGURE 2. Waveform for Inverting and Non-inverting Functions

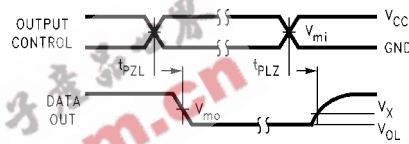

FIGURE 4. 3-STATE Output Low Enable and Disable Times for Low Voltage Logic

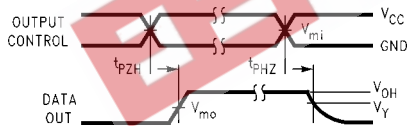

FIGURE 3. 3-STATE Output High Enable and Disable Times for Low Voltage Logic

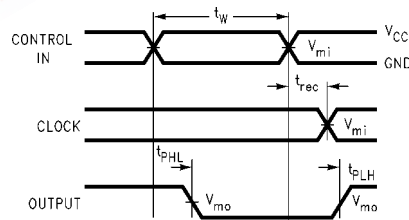

FIGURE 5. Propagation Delay, Pulse Width and  $t_{rec}$  Waveforms

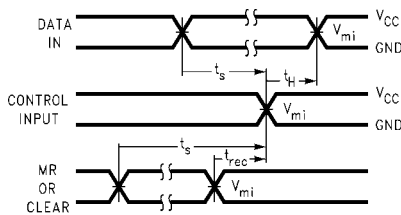
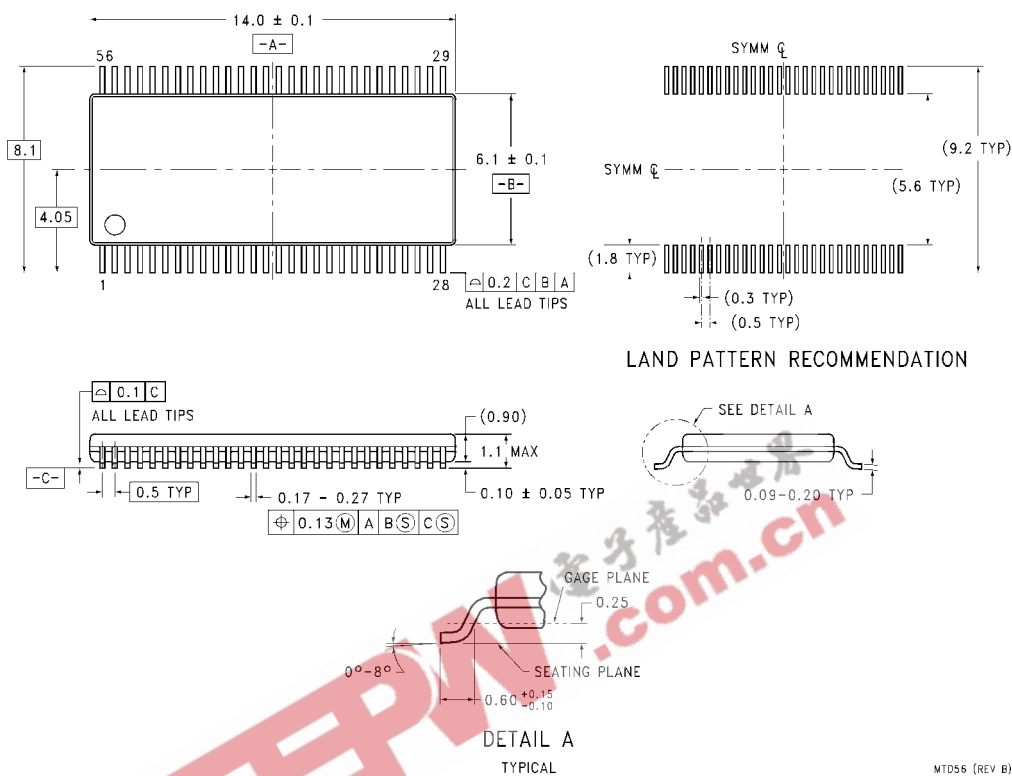

FIGURE 6. Setup Time, Hold Time and Recovery Time for Low Voltage Logic

Symbol	$V_{CC}$		
	$3.3V \pm 0.3V$	$2.5V \pm 0.2V$	$1.8V \pm 0.15V$
$V_{mi}$	1.5V	$V_{CC}/2$	$V_{CC}/2$
$V_{mo}$	1.5V	$V_{CC}/2$	$V_{CC}/2$
$V_X$	$V_{OL} + 0.3V$	$V_{OL} + 0.15V$	$V_{OL} + 0.15V$
$V_Y$	$V_{OH} - 0.3V$	$V_{OH} - 0.15V$	$V_{OH} - 0.15V$

**Physical Dimensions** inches (millimeters) unless otherwise noted



**56-Lead Thin Shrink Small Outline Package (TSSOP), JEDEC MO-153, 6.1mm Wide  
Package Number MTD56**

**LIFE SUPPORT POLICY**

FAIRCHILD'S PRODUCTS ARE NOT AUTHORIZED FOR USE AS CRITICAL COMPONENTS IN LIFE SUPPORT DEVICES OR SYSTEMS WITHOUT THE EXPRESS WRITTEN APPROVAL OF THE PRESIDENT OF FAIRCHILD SEMICONDUCTOR CORPORATION. As used herein:

1. Life support devices or systems are devices or systems which, (a) are intended for surgical implant into the body, or (b) support or sustain life, and (c) whose failure to perform when properly used in accordance with instructions for use provided in the labeling, can be reasonably expected to result in a significant injury to the user.
2. A critical component in any component of a life support device or system whose failure to perform can be reasonably expected to cause the failure of the life support device or system, or to affect its safety or effectiveness.

[www.fairchildsemi.com](http://www.fairchildsemi.com)