

DATA SHEET

For a complete data sheet, please also download:

- The IC06 74HC/HCT/HCU/HCMOS Logic Family Specifications
- The IC06 74HC/HCT/HCU/HCMOS Logic Package Information
- The IC06 74HC/HCT/HCU/HCMOS Logic Package Outlines

EEPW 电子产品世界
.com.cn

74HC/HCT540

Octal buffer/line driver; 3-state;
inverting

Product specification
File under Integrated Circuits, IC06

December 1990

Octal buffer/line driver; 3-state; inverting

74HC/HCT540

FEATURES

- Inverting outputs
- Output capability: bus driver
- I_{CC} category: MSI

The 74HC/HCT540 are octal inverting buffer/line drivers with 3-state outputs. The 3-state outputs are controlled by the output enable inputs \overline{OE}_1 and \overline{OE}_2 .

A HIGH on \overline{OE}_n causes the outputs to assume a high impedance OFF-state.

The "540" is identical to the "541" but has inverting outputs.

GENERAL DESCRIPTION

The 74HC/HCT540 are high-speed Si-gate CMOS devices and are pin compatible with low power Schottky TTL (LSTTL). They are specified in compliance with JEDEC standard no. 7A.

QUICK REFERENCE DATA

GND = 0 V; $T_{amb} = 25\text{ }^\circ\text{C}$; $t_r = t_f = 6\text{ ns}$

SYMBOL	PARAMETER	CONDITIONS	TYPICAL		UNIT
			HC	HCT	
t_{PHL}/t_{PLH}	propagation delay A_n to \overline{Y}_n	$C_L = 15\text{ pF}$; $V_{CC} = 5\text{ V}$	9	11	ns
C_I	input capacitance		3.5	3.5	pF
C_{PD}	power dissipation capacitance per buffer	notes 1 and 2	39	44	pF

Notes

1. C_{PD} is used to determine the dynamic power dissipation (P_D in μW):

$$P_D = C_{PD} \times V_{CC}^2 \times f_i + \sum (C_L \times V_{CC}^2 \times f_o) \text{ where:}$$

f_i = input frequency in MHz

f_o = output frequency in MHz

$\sum (C_L \times V_{CC}^2 \times f_o)$ = sum of outputs

C_L = output load capacitance in pF

V_{CC} = supply voltage in V

2. For HC the condition is $V_I = \text{GND to } V_{CC}$
For HCT the condition is $V_I = \text{GND to } V_{CC} - 1.5\text{ V}$

ORDERING INFORMATION

See "74HC/HCT/HCU/HCMOS Logic Package Information".

Octal buffer/line driver; 3-state; inverting

74HC/HCT540

PIN DESCRIPTION

PIN NO.	SYMBOL	NAME AND FUNCTION
1, 19	$\overline{OE}_1, \overline{OE}_2$	output enable input (active LOW)
2, 3, 4, 5, 6, 7, 8, 9	A_0 to A_7	data inputs
10	GND	ground (0 V)
18, 17, 16, 15, 14, 13, 12, 11	\overline{Y}_0 to \overline{Y}_7	bus outputs
20	V_{CC}	positive supply voltage

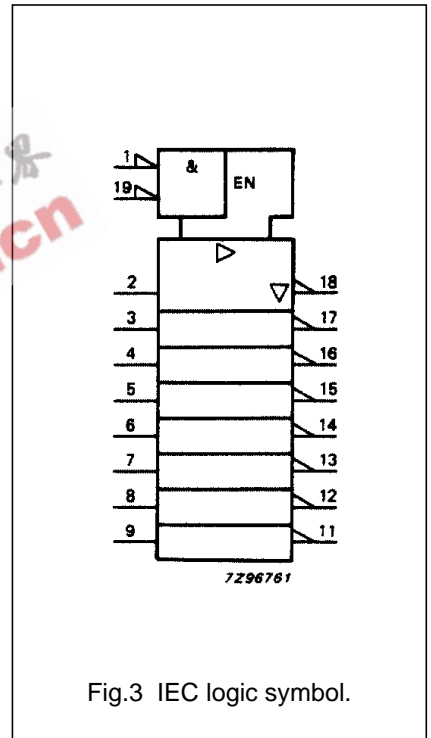
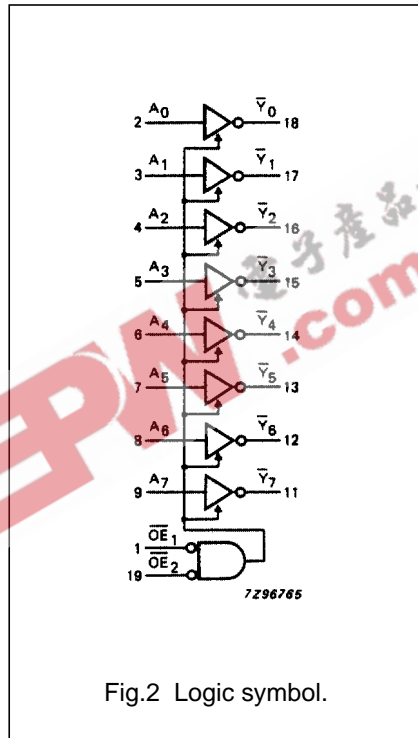
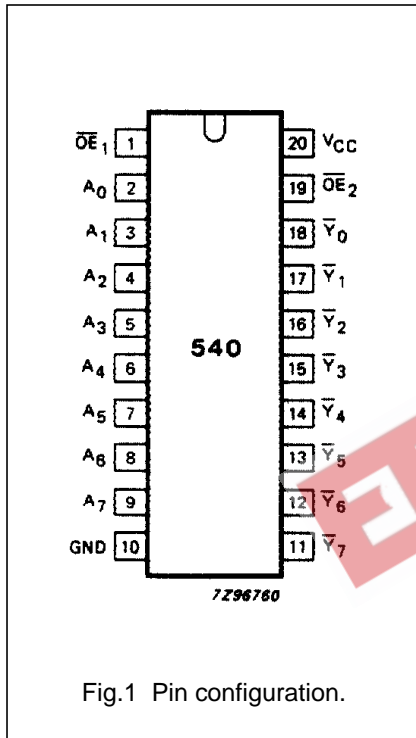

Octal buffer/line driver; 3-state; inverting

74HC/HCT540

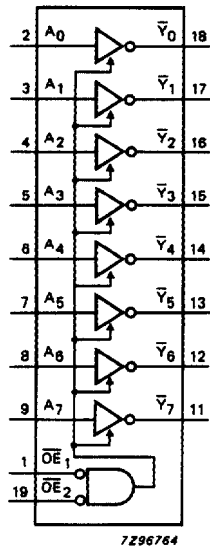

Fig.4 Functional diagram.

FUNCTION TABLE

INPUTS			OUTPUT
\overline{OE}_1	\overline{OE}_2	A_n	\overline{Y}_n
L	L	L	H
L	L	H	L
X	H	X	Z
H	X	X	Z

Notes

- 1. H = HIGH voltage level
- L = LOW voltage level
- X = don't care
- Z = high impedance OFF-state

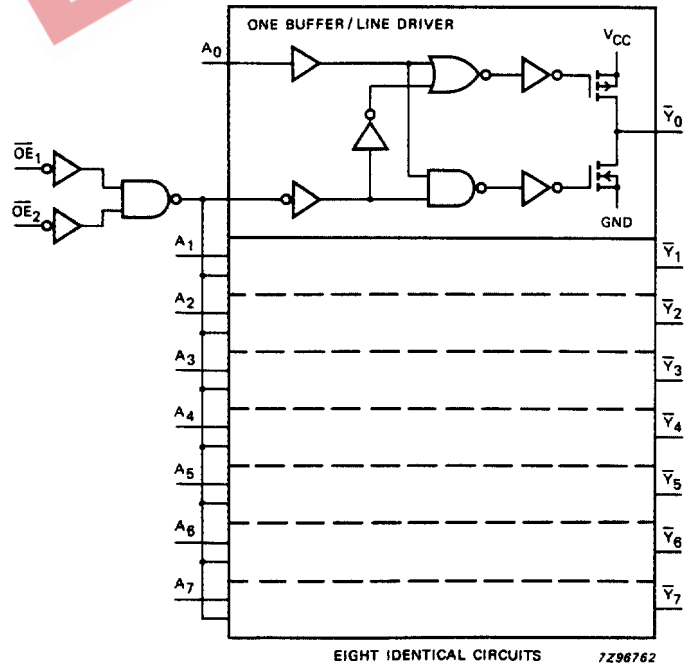
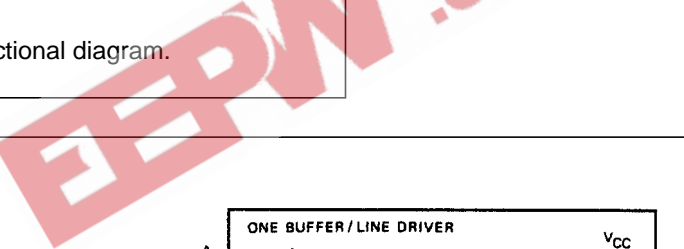

Fig.5 Logic diagram.

Octal buffer/line driver; 3-state; inverting

74HC/HCT540

DC CHARACTERISTICS FOR 74HC

For the DC characteristics see *"74HC/HCT/HCU/HCMOS Logic Family Specifications"*.

Output capability: bus driver

I_{CC} category: MSI

AC CHARACTERISTICS FOR 74HC

GND = 0 V; t_r = t_f = 6 ns; C_L = 50 pF

SYMBOL	PARAMETER	T _{amb} (°C)						UNIT	TEST CONDITIONS		
		74HC							V _{CC} (V)	WAVEFORMS	
		+25			-40 to +85		-40 to +125				
		min.	typ.	max.	min.	max.	min.				max.
t _{PHL} / t _{PLH}	propagation delay A _n to \bar{Y}_n		30 11 9	100 20 17		125 25 21	150 30 26	ns	2.0 4.5 6.0	Fig.6	
t _{PZH} / t _{PZL}	3-state output enable time \bar{OE} to \bar{Y}_n		52 19 15	160 32 27		200 40 34	240 48 41	ns	2.0 4.5 6.0	Fig.7	
t _{PHZ} / t _{PLZ}	3-state output disable time \bar{OE} to \bar{Y}_n		61 22 18	160 32 27		200 40 34	240 48 41	ns	2.0 4.5 6.0	Fig.7	
t _{THL} / t _{TLH}	output transition time		14 5 4	60 12 10		75 15 13	90 18 15	ns	2.0 4.5 6.0	Fig.6	

Octal buffer/line driver; 3-state; inverting

74HC/HCT540

DC CHARACTERISTICS FOR 74HCT

For the DC characteristics see *"74HC/HCT/HCU/HCMOS Logic Family Specifications"*.

Output capability: bus driver

I_{CC} category: MSI

Note to HCT types

The value of additional quiescent supply current (ΔI_{CC}) for a unit load of 1 is given in the family specifications. To determine ΔI_{CC} per input, multiply this value by the unit load coefficient shown in the table below.

INPUT	UNIT LOAD COEFFICIENT
\overline{OE}_1	1.50
\overline{OE}_2	1.00
A_n	1.40

AC CHARACTERISTICS FOR 74HCT

GND = 0 V; $t_r = t_f = 6$ ns; $C_L = 50$ pF

SYMBOL	PARAMETER	T _{amb} (°C)							UNIT	TEST CONDITIONS	
		74HCT								V _{CC} (V)	WAVEFORMS
		+25			-40 to +85		-40 to +125				
		min.	typ.	max.	min.	max.	min.	max.			
t _{PHL} / t _{PLH}	propagation delay A _n to \overline{Y}_n		13	24		30		36	ns	4.5	Fig.6
t _{PZH} / t _{PZL}	3-state output enable time \overline{OE} to \overline{Y}_n		22	35		44		53	ns	4.5	Fig.7
t _{PHZ} / t _{PLZ}	3-state output disable time \overline{OE} to \overline{Y}_n		23	35		44		53	ns	4.5	Fig.7
t _{THL} / t _{TLH}	output transition time		5	12		15		18	ns	4.5	Fig.6

Octal buffer/line driver; 3-state; inverting

74HC/HCT540

AC WAVEFORMS

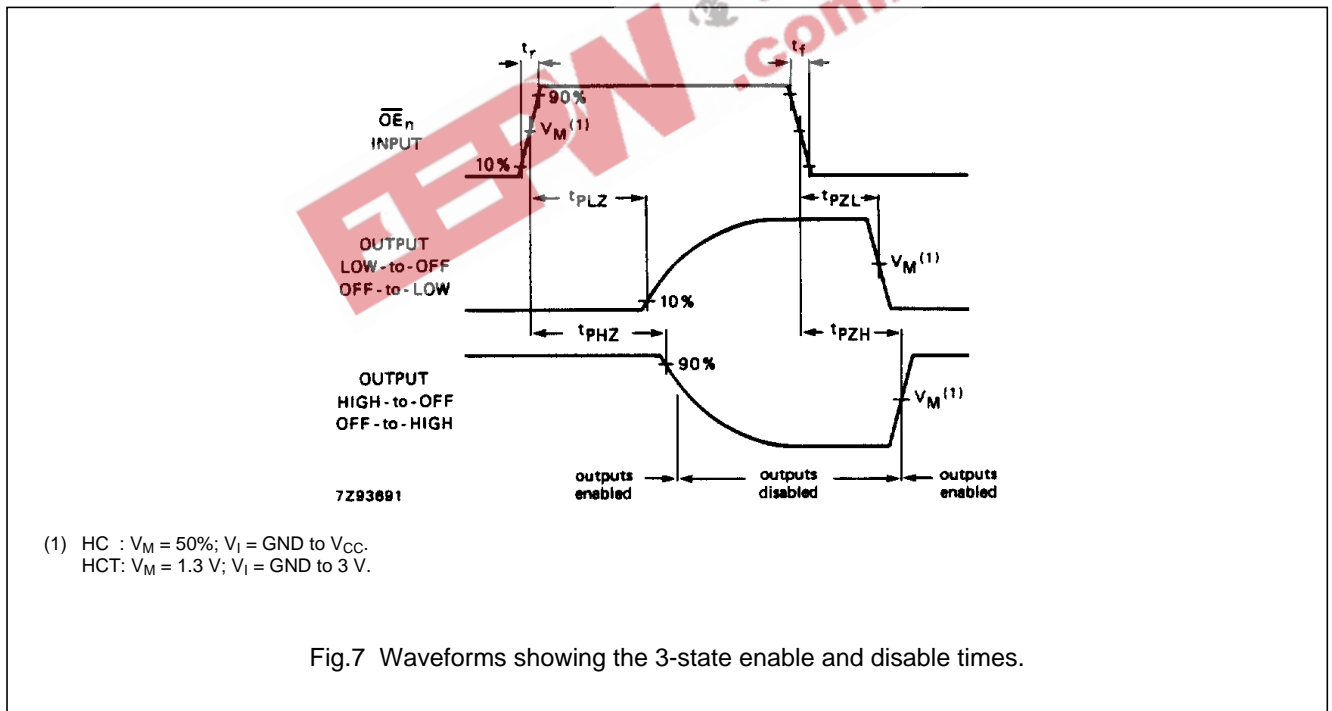
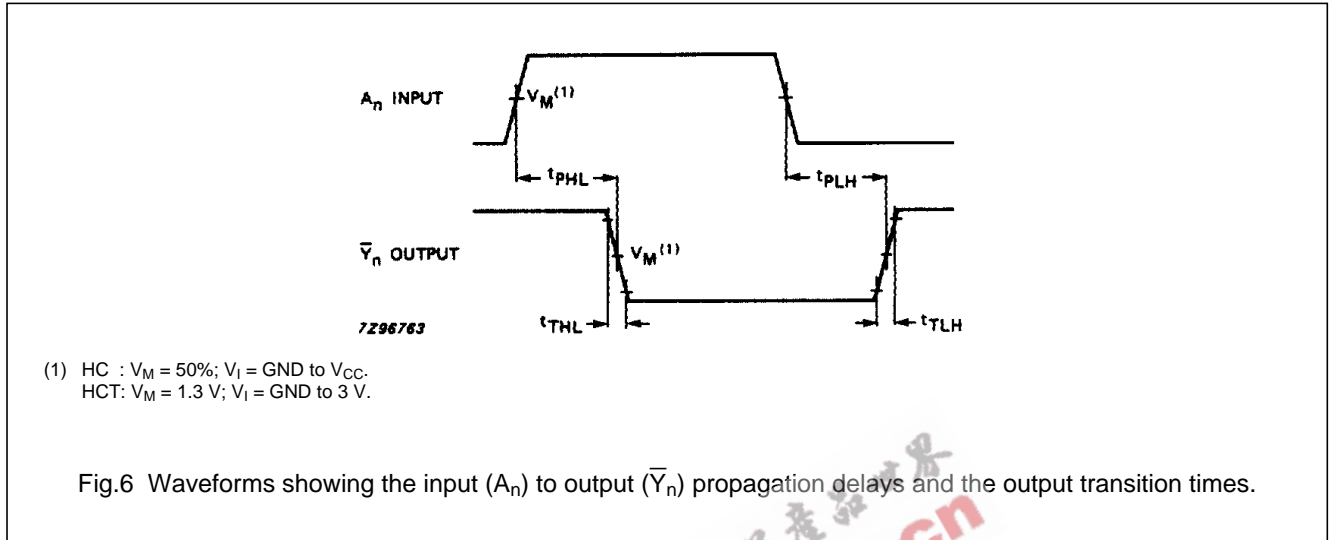

PACKAGE OUTLINES

See "74HC/HCT/HCU/HCMOS Logic Package Outlines".