

# DATA SHEET

For a complete data sheet, please also download:

- The IC06 74HC/HCT/HCU/HCMOS Logic Family Specifications
- The IC06 74HC/HCT/HCU/HCMOS Logic Package Information
- The IC06 74HC/HCT/HCU/HCMOS Logic Package Outlines

EEPW 电子产品世界  
.com.cn

## 74HC/HCT574

Octal D-type flip-flop; positive edge-trigger; 3-state

Product specification  
File under Integrated Circuits, IC06

December 1990

## Octal D-type flip-flop; positive edge-trigger; 3-state

## 74HC/HCT574

### FEATURES

- 3-state non-inverting outputs for bus oriented applications
- 8-bit positive edge-triggered register
- Common 3-state output enable input
- Independent register and 3-state buffer operation
- Output capability: bus driver
- I<sub>CC</sub> category: MSI

### GENERAL DESCRIPTION

The 74HC/HCT574 are high-speed Si-gate CMOS devices and are pin compatible with low power Schottky TTL (LSTTL). They are specified in compliance with JEDEC standard no. 7A.

The 74HC/HCT574 are octal D-type flip-flops featuring separate D-type inputs for each flip-flop and non-inverting 3-state outputs for bus oriented applications. A clock (CP) and an output enable ( $\overline{OE}$ ) input are common to all flip-flops.

The 8 flip-flops will store the state of their individual D-inputs that meet the set-up and hold time requirements on the LOW-to-HIGH CP transition. When  $\overline{OE}$  is LOW, the contents of the 8 flip-flops are available at the outputs.

When  $\overline{OE}$  is HIGH, the outputs go to the high impedance OFF-state. Operation of the  $\overline{OE}$  input does not affect the state of the flip-flops.

The "574" is functionally identical to the "564", but has non-inverting outputs.

The "574" is functionally identical to the "374", but has a different pinning.

### QUICK REFERENCE DATA

GND = 0 V; T<sub>amb</sub> = 25 °C; t<sub>r</sub> = t<sub>f</sub> = 6 ns

SYMBOL	PARAMETER	CONDITIONS	TYPICAL		UNIT
			HC	HCT	
t <sub>PHL</sub> / t <sub>PLH</sub>	propagation delay CP to Q <sub>n</sub>	C <sub>L</sub> = 15 pF; V <sub>CC</sub> = 5 V	14	15	ns
f <sub>max</sub>	maximum clock frequency		123	76	MHz
C <sub>I</sub>	input capacitance		3.5	3.5	pF
C <sub>PD</sub>	power dissipation capacitance per flip-flop	notes 1 and 2	22	25	pF

### Notes

1. C<sub>PD</sub> is used to determine the dynamic power dissipation (P<sub>D</sub> in μW):

$$P_D = C_{PD} \times V_{CC}^2 \times f_i + \sum (C_L \times V_{CC}^2 \times f_o) \text{ where:}$$

f<sub>i</sub> = input frequency in MHz

f<sub>o</sub> = output frequency in MHz

∑ (C<sub>L</sub> × V<sub>CC</sub><sup>2</sup> × f<sub>o</sub>) = sum of outputs

C<sub>L</sub> = output load capacitance in pF

V<sub>CC</sub> = supply voltage in V

2. For HC the condition is V<sub>I</sub> = GND to V<sub>CC</sub>  
For HCT the condition is V<sub>I</sub> = GND to V<sub>CC</sub> - 1.5 V

### ORDERING INFORMATION

See "74HC/HCT/HCU/HCMOS Logic Package Information".

Octal D-type flip-flop; positive edge-trigger;  
3-state

74HC/HCT574

PIN DESCRIPTION

PIN NO.	SYMBOL	NAME AND FUNCTION
1	$\overline{OE}$	3-state output enable input (active LOW)
2, 3, 4, 5, 6, 7, 8, 9	D <sub>0</sub> to D <sub>7</sub>	data inputs
10	GND	ground (0 V)
11	CP	clock input (LOW-to-HIGH, edge-triggered)
19, 18, 17, 16, 15, 14, 13, 12	Q <sub>0</sub> to Q <sub>7</sub>	3-state flip-flop outputs
20	V <sub>CC</sub>	positive supply voltage

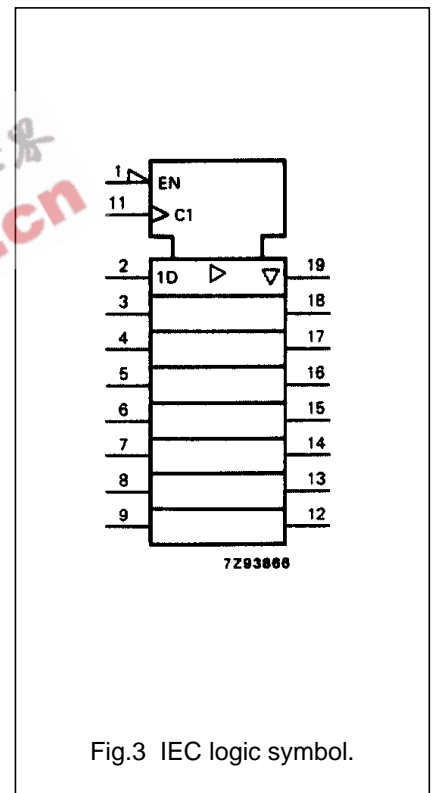
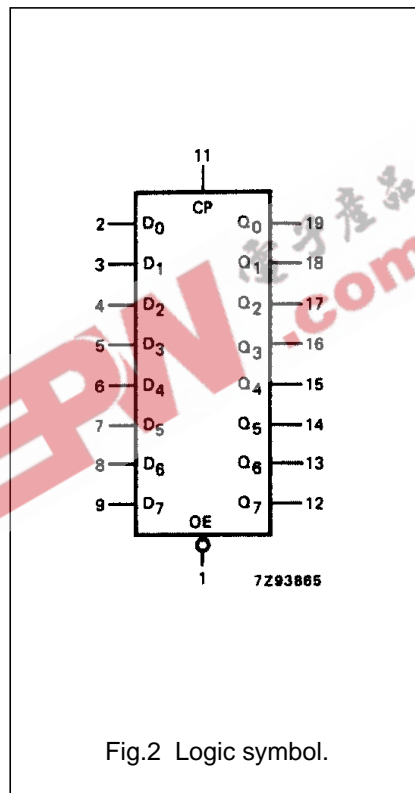
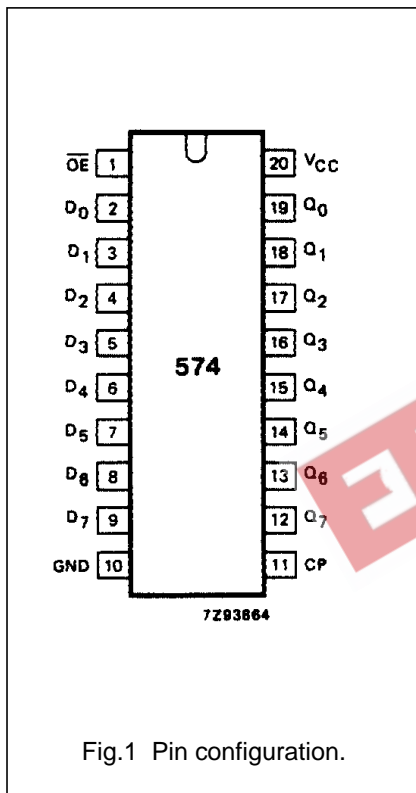

Octal D-type flip-flop; positive edge-trigger;  
3-state

74HC/HCT574

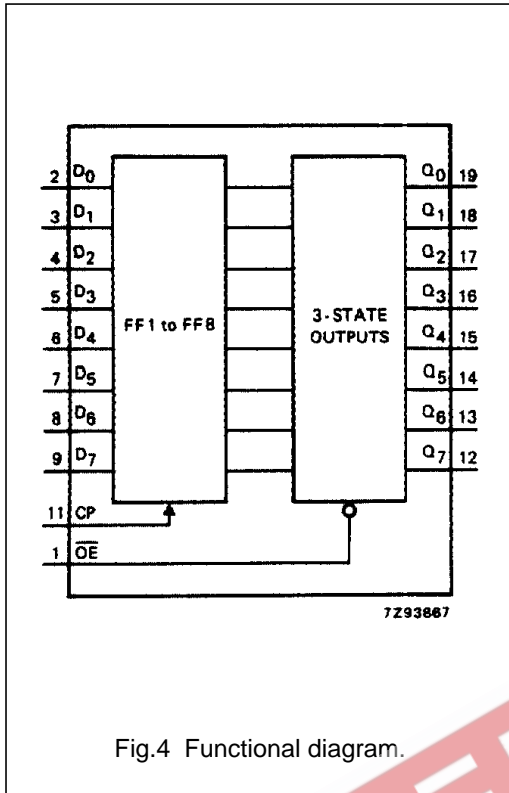

Fig.4 Functional diagram.

FUNCTION TABLE

OPERATING MODES	INPUTS			INTERNAL FLIP-FLOPS	OUTPUTS Q <sub>0</sub> to Q <sub>7</sub>
	$\overline{OE}$	CP	D <sub>n</sub>		
load and read register	L	↑	l	L	L
register	L	↑	h	H	H
load register and disable outputs	H	↑	l	L	Z
	H	↑	h	H	Z

Notes

- H = HIGH voltage level  
h = HIGH voltage level one set-up time prior to the LOW-to-HIGH CP transition  
L = LOW voltage level  
l = LOW voltage level on set-up time prior to the LOW-to-HIGH CP transition  
Z = HIGH impedance OFF-state  
↑ = LOW-to-HIGH clock transition

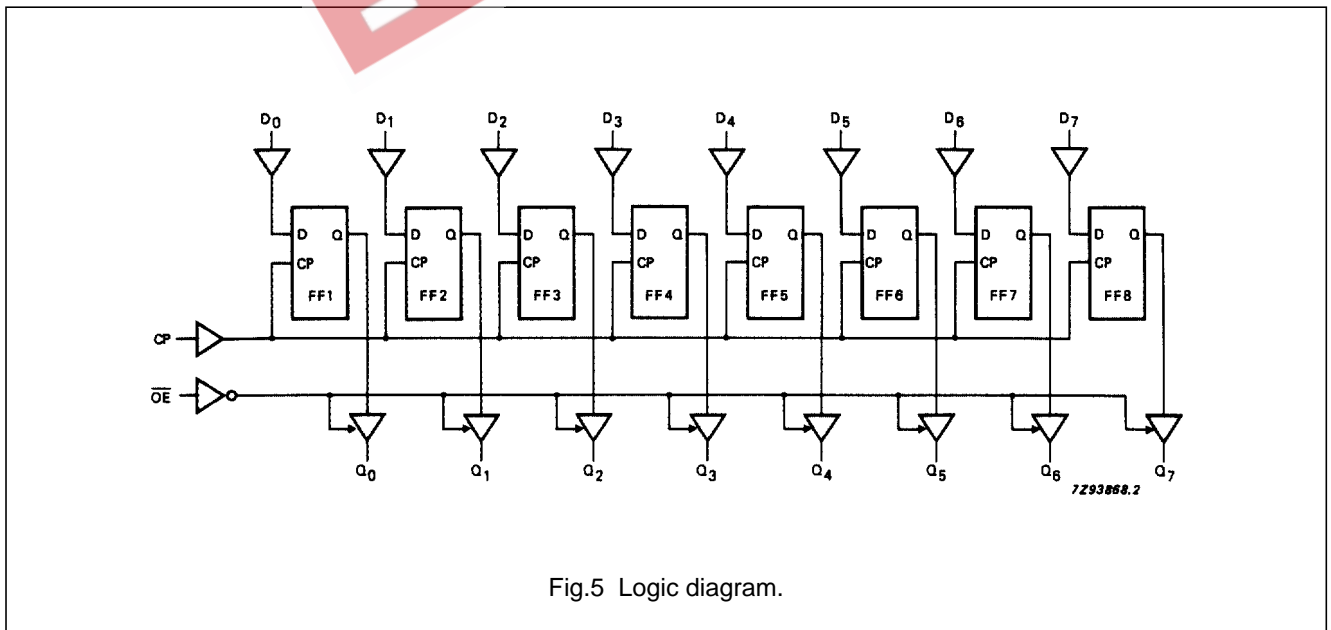

Fig.5 Logic diagram.

# Octal D-type flip-flop; positive edge-trigger; 3-state

74HC/HCT574

## DC CHARACTERISTICS FOR 74HC

For the DC characteristics see *"74HC/HCT/HCU/HCMOS Logic Family Specifications"*.

Output capability: bus driver

I<sub>CC</sub> category: MSI

## AC CHARACTERISTICS FOR 74HC

GND = 0 V; t<sub>r</sub> = t<sub>f</sub> = 6 ns; C<sub>L</sub> = 50 pF

SYMBOL	PARAMETER	T <sub>amb</sub> (°C)						UNIT	TEST CONDITIONS		
		74HC							V <sub>CC</sub> (V)	WAVEFORMS	
		+25			-40 to +85		-40 to +125				
		min.	typ.	max.	min.	max.	min.				max.
t <sub>PHL</sub> / t <sub>PLH</sub>	propagation delay CP to Q <sub>n</sub>		47 17 14	150 30 26		190 35 33	225 45 38	ns	2.0 4.5 6.0	Fig.6	
t <sub>PZH</sub> / t <sub>PZL</sub>	3-state output enable time OE to Q <sub>n</sub>		44 16 13	140 28 24		175 35 30	210 42 36	ns	2.0 4.5 6.0	Fig.7	
t <sub>PHZ</sub> / t <sub>PLZ</sub>	3-state output disable time $\overline{OE}$ to Q <sub>n</sub>		39 14 11	125 25 21		155 31 26	190 38 32	ns	2.0 4.5 6.0	Fig.7	
t <sub>THL</sub> / t <sub>TLH</sub>	output transition time		14 5 4	60 12 10		75 15 13	90 18 15	ns	2.0 4.5 6.0	Fig.6	
t <sub>W</sub>	clock pulse width HIGH or LOW	80 16 14	14 5 4		100 20 17		120 24 20	ns	2.0 4.5 6.0	Fig.6	
t <sub>SU</sub>	set-up time D <sub>n</sub> to CP	60 12 10	6 2 2		75 15 13		90 18 15	ns	2.0 4.5 6.0	Fig.8	
t <sub>H</sub>	hold time D <sub>n</sub> to CP	5 5 5	0 0 0		5 5 5		5 5 5	ns	2.0 4.5 6.0	Fig.8	
f <sub>max</sub>	maximum clock pulse frequency	6.0 30 35	37 112 133		4.8 24 28		4.0 20 24	MHz	2.0 4.5 6.0	Fig.6	

# Octal D-type flip-flop; positive edge-trigger; 3-state

74HC/HCT574

## DC CHARACTERISTICS FOR 74HCT

For the DC characteristics see *"74HC/HCT/HCU/HCMOS Logic Family Specifications"*.

Output capability: bus driver

I<sub>CC</sub> category: MSI

### Note to HCT types

The value of additional quiescent supply current ( $\Delta I_{CC}$ ) for a unit load of 1 is given in the family specifications. To determine  $\Delta I_{CC}$  per input, multiply this value by the unit load coefficient shown in the table below.

INPUT	UNIT LOAD COEFFICIENT
D <sub>n</sub>	0.5
$\overline{OE}$	1.25
CP	1.5

## AC CHARACTERISTICS FOR 74HCT

GND = 0 V; t<sub>r</sub> = t<sub>f</sub> = 6 ns; C<sub>L</sub> = 50 pF

SYMBOL	PARAMETER	T <sub>amb</sub> (°C)							UNIT	TEST CONDITIONS		
		74HCT								V <sub>CC</sub> (V)	WAVEFORMS	
		+25			-40 to +85		-40 to +125					min.
t <sub>PHL</sub> / t <sub>PLH</sub>	propagation delay CP to Q <sub>n</sub>	min.	typ.	max.	min.	max.	min.	max.	ns	4.5	Fig.6	
t <sub>PZH</sub> / t <sub>PZL</sub>	3-state output enable time $\overline{OE}$ to Q <sub>n</sub>		19	33		41		50	ns	4.5	Fig.7	
t <sub>PHZ</sub> / t <sub>PLZ</sub>	3-state output disable time $\overline{OE}$ to Q <sub>n</sub>		16	28		35		42	ns	4.5	Fig.7	
t <sub>THL</sub> / t <sub>TLH</sub>	output transition time		5	12		15		18	ns	4.5	Fig.6	
t <sub>W</sub>	clock pulse width HIGH or LOW	16	7		20		24		ns	4.5	Fig.6	
t <sub>SU</sub>	set-up time D <sub>n</sub> to CP	12	3		15		18		ns	4.5	Fig.8	
t <sub>H</sub>	hold time D <sub>n</sub> to CP	5	-1		5		5		ns	4.5	Fig.8	
f <sub>max</sub>	maximum clock pulse frequency	30	69		24		20		MHz	4.5	Fig.6	

Octal D-type flip-flop; positive edge-trigger;  
3-state

74HC/HCT574

AC WAVEFORMS

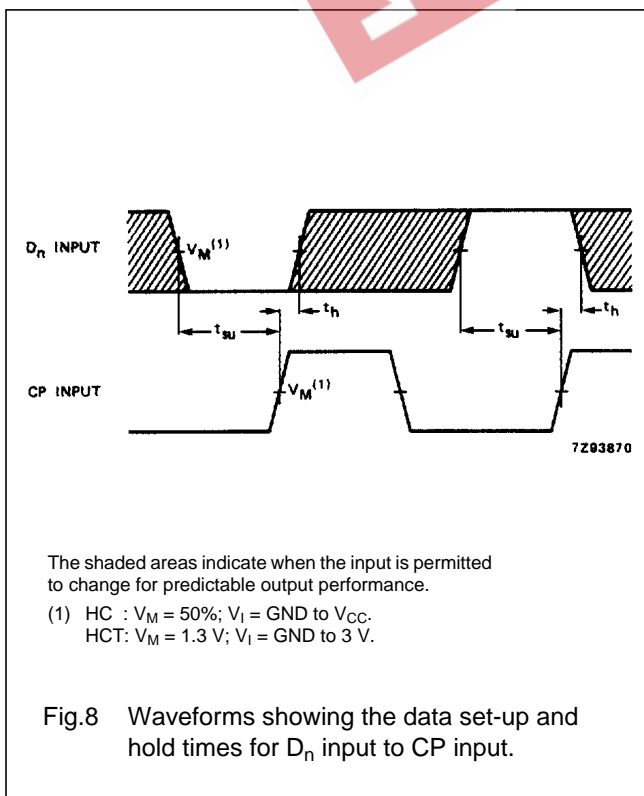
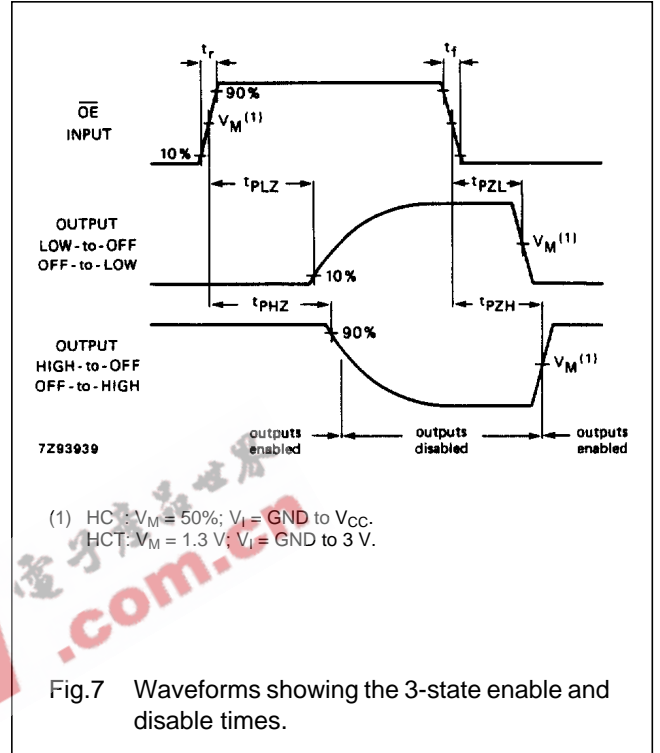
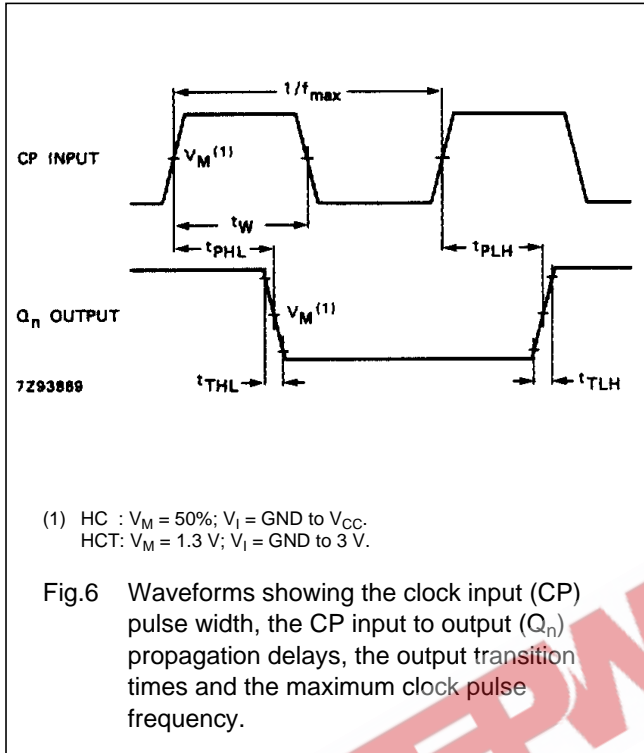

PACKAGE OUTLINES

See "74HC/HCT/HCU/HCMOS Logic Package Outlines".