

**3-TERMINAL POSITIVE LINEAR REGULATOR****AZ78LXX****General Description**

The AZ78LXX series are three terminal positive regulators with several fixed output voltages. These regulators can provide local on card regulation, eliminating the distribution problems associated with single point regulation. The AZ78LXX can be used in logic systems, instrumentation, HiFi, and other solid state electronic equipment. When used as a Zener diode/resistor combination replacement, the AZ78LXX usually results an effective output impedance improvement of two orders of magnitude, and lower quiescent current.

With adequate heat sinking the AZ78LXX can deliver 100 mA output current. Current limiting is included to limit the peak output current to a safe value. Thermal protection is also provided. If internal power dissipation becomes too high for the heat sinking provided, the thermal shutdown circuit takes over preventing the IC from overheating.

The AZ78LXX are available in the plastic TO-92, SOIC-8, SOT-223 and SOT-89 packages.

**Features**

- Output Current up to 100 mA
- Fixed Output Voltage of 5V, 8V, 9V and 12V
- Output Voltage Tolerances of  $\pm 5\%$  over the Full Temperature Range
- Internal Short Circuit Current-Limiting
- Internal Thermal Overload Protection
- No External Components

**Applications**

- High Efficiency Linear Regulator
- Post Regulation for Switching Supply
- Microprocessor Power Supply
- Mother Board I/O Power Supply

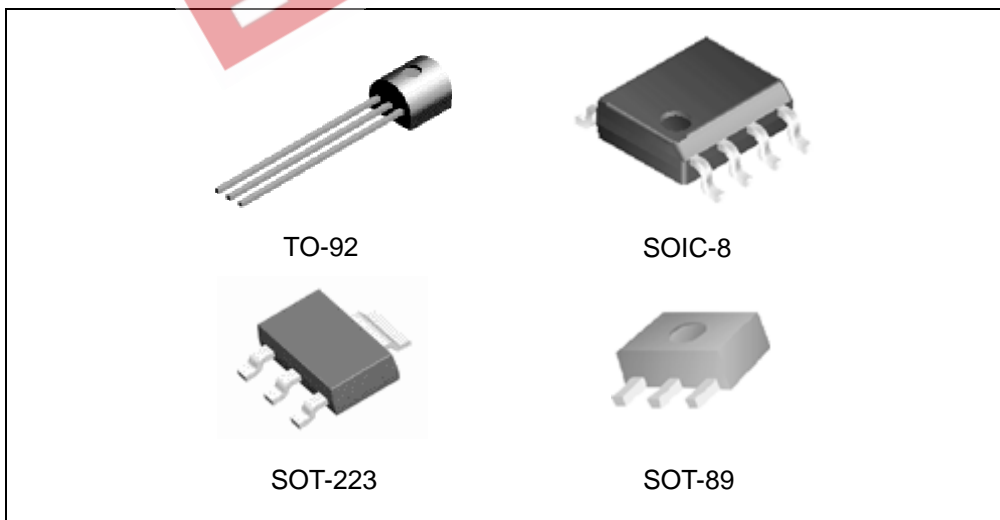

Figure 1. Package Types of the AZ78LXX



**3-TERMINAL POSITIVE LINEAR REGULATOR**

**AZ78LXX**

**Pin Configuration**

Z Package  
(TO-92)

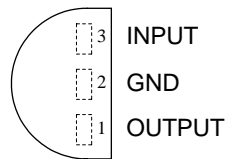

H Package  
(SOT-223)

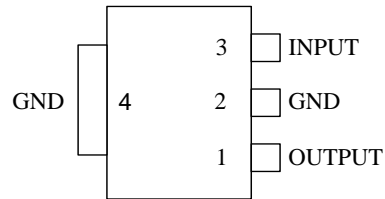

Connect pin 4 to pin 2 or leave pin 4 electrically isolated

M Package  
(SOIC-8)

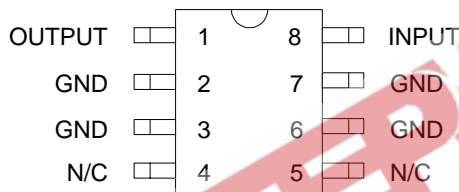

R Package  
(SOT-89)

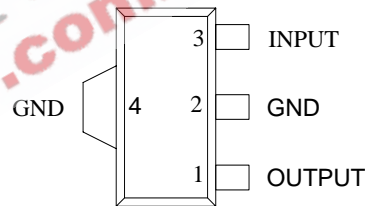

Figure 2. Pin Configuration of the AZ78LXX (Top View)



**3-TERMINAL POSITIVE LINEAR REGULATOR**

**AZ78LXX**

**Functional Block Diagram**



Figure 3. Functional Block Diagram of the AZ78LXX



**3-TERMINAL POSITIVE LINEAR REGULATOR**

**AZ78LXX**

**Ordering Information**



Package	Temperature Range	Part Number		Marking ID		Packing Type
		Tin Lead	Lead Free	Tin Lead	Lead Free	
TO-92	0 to 125°C	AZ78L05Z	AZ78L05Z-E1	AZ78L05Z	AZ78L05Z-E1	Bulk
		AZ78L05ZTR	AZ78L05ZTR-E1	AZ78L05Z	AZ78L05Z-E1	Ammo
		AZ78L08Z	AZ78L08Z-E1	AZ78L08Z	AZ78L08Z-E1	Bulk
		AZ78L08ZTR	AZ78L08ZTR-E1	AZ78L08Z	AZ78L08Z-E1	Ammo
		AZ78L09Z	AZ78L09Z-E1	AZ78L09Z	AZ78L09Z-E1	Bulk
		AZ78L09ZTR	AZ78L09ZTR-E1	AZ78L09Z	AZ78L09Z-E1	Ammo
		AZ78L12Z	AZ78L12Z-E1	AZ78L12Z	AZ78L12Z-E1	Bulk
		AZ78L12ZTR	AZ78L12ZTR-E1	AZ78L12Z	AZ78L12Z-E1	Ammo
SOIC-8	0 to 125°C	AZ78L05M	AZ78L05M-E1	78L05M	78L05M-E1	Tube
		AZ78L05MTR	AZ78L05MTR-E1	78L05M	78L05M-E1	Tape & Reel
		AZ78L08M	AZ78L08M-E1	78L08M	78L08ZM-E1	Tube
		AZ78L08MTR	AZ78L08MTR-E1	78L08M	78L08M-E1	Tape & Reel
		AZ78L09M	AZ78L09M-E1	78L09M	78L09M-E1	Tube
		AZ78L09MTR	AZ78L09MTR-E1	78L09M	78L09M-E1	Tape & Reel
		AZ78L12M	AZ78L12M-E1	78L12M	78L12M-E1	Tube
		AZ78L12MTR	AZ78L12ZMTR-E1	78L12M	78L12M-E1	Tape & Reel
SOT-89	0 to 125°C	AZ78L05RTR	AZ78L05RTR-E1	R78A	E78A	Tape & Reel
		AZ78L08RTR	AZ78L08RTR-E1	R78B	E78B	Tape & Reel
		AZ78L09RTR	AZ78L09RTR-E1	R78C	E78C	Tape & Reel
		AZ78L12RTR	AZ78L12RTR-E1	R78D	E78D	Tape & Reel
SOT-223	0 to 125°C	AZ78L05HTR	AZ78L05HTR-E1	H78A	EH78A	Tape & Reel
		AZ78L08HTR	AZ78L08HTR-E1	H78B	EH78B	Tape & Reel
		AZ78L09HTR	AZ78L09HTR-E1	H78C	EH78C	Tape & Reel
		AZ78L12HTR	AZ78L12HTR-E1	H78D	EH78D	Tape & Reel

BCD Semiconductor's Pb-free products, as designated with "E1" suffix in the part number, are RoHS compliant.

**3-TERMINAL POSITIVE LINEAR REGULATOR****AZ78LXX****Absolute Maximum Ratings (Note 1)**

Parameter	Symbol	Value		Unit
Input Voltage	$V_{CC}$	20		V
Operating Junction Temperature Range	$T_J$	0 to 125		°C
Lead Temperature (Soldering, 10sec)	$T_{LEAD}$	265		°C
Power Dissipation ( $T_A=25^\circ\text{C}$ )	$P_D$	TO-92	0.65	W
		SOIC-8	0.6	
		SOT-223	0.7	
		SOT-89	0.65	
Storage Temperature Range	$T_{STG}$	-65 to 150		°C
ESD (Machine Model)		300		V

Note 1: Stresses greater than those listed under "Absolute Maximum Ratings" may cause permanent damage to the device. These are stress ratings only, and functional operation of the device at these or any other conditions beyond those indicated under "Recommended Operating Conditions" is not implied. Exposure to "Absolute Maximum Ratings" for extended periods may affect device reliability.

**Recommended Operating Conditions**

Parameter	Symbol	Min	Max	Unit
Operating Junction Temperature Range	$T_J$	0	125	°C

**3-TERMINAL POSITIVE LINEAR REGULATOR****AZ78LXX****Electrical Characteristics****AZ78L05 Electrical Characteristics**

Limits in standard typeface are for  $T_J = 25^\circ\text{C}$ , **Bold typeface applies over  $0^\circ\text{C}$  to  $125^\circ\text{C}$** ,  $I_O = 40\text{ mA}$ ,  $C_I = 0.33\mu\text{F}$ ,  $C_O = 0.1\mu\text{F}$ ,  $V_I = 10\text{V}$ , unless otherwise specified.

Parameter	Symbol	Conditions	Min	Typ	Max	Unit
Output Voltage	$V_O$		4.8	5	5.2	V
		$7.0\text{V} \leq V_I \leq 15\text{V}$ $1.0\text{mA} \leq I_O \leq 40\text{mA}$ (Note 2)	<b>4.75</b>		<b>5.25</b>	
Line Regulation	$V_{RLINE}$	$7.0\text{V} \leq V_I \leq 15\text{V}$		18	75	mV
Load Regulation	$V_{RLOAD}$	$1.0\text{mA} \leq I_O \leq 100\text{mA}$		20	60	mV
Quiescent Current	$I_Q$			3	5	mA
Quiescent Current Change	$\Delta I_Q$	$8.0\text{V} \leq V_I \leq 15\text{V}$			<b>1.0</b>	mA
		$1.0\text{mA} \leq I_O \leq 40\text{mA}$			<b>0.1</b>	
Output Noise Voltage	$N_O$	$10\text{Hz} \leq f \leq 100\text{kHz}$ (Note 3)		40		$\mu\text{V}$
Ripple Rejection	$\Delta V_I / \Delta V_O$	$f = 120\text{Hz}$ , $8.0\text{V} \leq V_I \leq 15\text{V}$	47	62		dB
Peak Output Current	$I_{PK}$			150		mA
Average Temperature Coefficient of Output Voltage	$\Delta V_O / \Delta T$	$I_O = 5.0\text{mA}$		-0.65		$\text{mV}/^\circ\text{C}$
Minimum Value of Input Voltage Required to Maintain Line Regulation	$V_I(\text{Min})$			6.7	7	V

Note 2: Power Dissipation  $\leq 0.6\text{W}$

Note 3: Recommended minimum load capacitance of  $0.01\mu\text{F}$  to limit high frequency noise.

**3-TERMINAL POSITIVE LINEAR REGULATOR****AZ78LXX****Electrical Characteristics (Continued)****AZ78L08 Electrical Characteristics**

Limits in standard typeface are for  $T_J = 25^\circ\text{C}$ , **Bold typeface applies over  $0^\circ\text{C}$  to  $125^\circ\text{C}$** ,  $I_O = 40\text{ mA}$ ,  $C_1 = 0.33\mu\text{F}$ ,  $C_O = 0.1\mu\text{F}$ ,  $V_I = 14\text{V}$ , unless otherwise specified.

Parameter	Symbol	Conditions	Min	Typ	Max	Unit
Output Voltage	$V_O$		7.7	8.0	8.3	V
		$11\text{V} \leq V_I \leq 18\text{V}$ $1.0\text{mA} \leq I_O \leq 40\text{mA}$ (Note 2)	<b>7.6</b>		<b>8.4</b>	
Line Regulation	$V_{RLINE}$	$11\text{V} \leq V_I \leq 18\text{V}$		18	75	mV
Load Regulation	$V_{RLOAD}$	$1.0\text{mA} \leq I_O \leq 100\text{mA}$		20	90	mV
Quiescent Current	$I_Q$			3	5	mA
Quiescent Current Change	$\Delta I_Q$	$11\text{V} \leq V_I \leq 18\text{V}$			<b>1.5</b>	mA
		$1.0\text{mA} \leq I_O \leq 40\text{mA}$			<b>0.1</b>	
Output Noise Voltage	$N_O$	$10\text{Hz} \leq f \leq 100\text{kHz}$ (Note 3)		60		$\mu\text{V}$
Ripple Rejection	$\Delta V_I / \Delta V_O$	$f = 120\text{Hz}$ , $11\text{V} \leq V_I \leq 18\text{V}$	39	45		dB
Peak Output Current	$I_{PK}$			150		mA
Average Temperature Coefficient of Output Voltage	$\Delta V_O / \Delta T$	$I_O = 5.0\text{mA}$		-0.8		$\text{mV}/^\circ\text{C}$
Minimum Value of Input Voltage Required to Maintain Line Regulation	$V_I(\text{Min})$			9.7		V

Note 2: Power Dissipation  $\leq 0.6\text{W}$

Note 3: Recommended minimum load capacitance of  $0.01\mu\text{F}$  to limit high frequency noise.

**3-TERMINAL POSITIVE LINEAR REGULATOR****AZ78LXX****Electrical Characteristics (Continued)****AZ78L09 Electrical Characteristics**

Limits in standard typeface are for  $T_J = 25^\circ\text{C}$ , **Bold typeface applies over  $0^\circ\text{C}$  to  $125^\circ\text{C}$** ,  $I_O = 40\text{ mA}$ ,  $C_1 = 0.33\mu\text{F}$ ,  $C_O = 0.1\mu\text{F}$ ,  $V_I = 15\text{V}$ , unless otherwise specified.

Parameter	Symbol	Conditions	Min	Typ	Max	Unit
Output Voltage	$V_O$		8.6	9	9.4	V
		$12\text{V} \leq V_I \leq 18\text{V}$ $1.0\text{mA} \leq I_O \leq 40\text{mA}$ (Note 2)	<b>8.55</b>		<b>9.45</b>	
Line Regulation	$V_{RLINE}$	$12\text{V} \leq V_I \leq 18\text{V}$		18	75	mV
Load Regulation	$V_{RLOAD}$	$1.0\text{mA} \leq I_O \leq 100\text{mA}$		20	90	mV
Quiescent Current	$I_Q$			3	5	mA
Quiescent Current Change	$\Delta I_Q$	$12\text{V} \leq V_I \leq 18\text{V}$			<b>1.5</b>	mA
		$1.0\text{mA} \leq I_O \leq 40\text{mA}$			<b>0.1</b>	
Output Noise Voltage	$N_O$	$10\text{Hz} \leq f \leq 100\text{kHz}$ (Note 3)		70		$\mu\text{V}$
Ripple Rejection	$\Delta V_I / \Delta V_O$	$f = 120\text{Hz}$ , $12\text{V} \leq V_I \leq 18\text{V}$	38	44		dB
Peak Output Current	$I_{PK}$			150		mA
Average Temperature Coefficient of Output Voltage	$\Delta V_O / \Delta T$	$I_O = 5.0\text{mA}$		-0.9		$\text{mV}/^\circ\text{C}$
Minimum Value of Input Voltage Required to Maintain Line Regulation	$V_I(\text{Min})$			10.7		V

Note 2: Power Dissipation  $\leq 0.6\text{W}$

Note 3: Recommended minimum load capacitance of  $0.01\mu\text{F}$  to limit high frequency noise.



**3-TERMINAL POSITIVE LINEAR REGULATOR****AZ78LXX****Electrical Characteristics (Continued)****AZ78L12 Electrical Characteristics**

Limits in standard typeface are for  $T_J = 25^\circ\text{C}$ , **Bold typeface applies over  $0^\circ\text{C}$  to  $125^\circ\text{C}$** ,  $I_O = 40\text{ mA}$ ,  $C_I = 0.33\mu\text{F}$ ,  $C_O = 0.1\mu\text{F}$ ,  $V_I = 18\text{V}$ , unless otherwise specified.

Parameter	Symbol	Conditions	Min	Typ	Max	Unit
Output Voltage	$V_O$		11.5	12	12.5	V
		$15\text{V} \leq V_I \leq 18\text{V}$ $1.0\text{mA} \leq I_O \leq 40\text{mA}$ (Note 2)	<b>11.4</b>		<b>12.6</b>	
Line Regulation	$V_{RLINE}$	$15\text{V} \leq V_I \leq 18\text{V}$		18	75	mV
Load Regulation	$V_{RLOAD}$	$1.0\text{mA} \leq I_O \leq 100\text{mA}$		20	90	mV
Quiescent Current	$I_Q$			3	5	mA
Quiescent Current Change	$\Delta I_Q$	$15\text{V} \leq V_I \leq 18\text{V}$			<b>1.5</b>	mA
		$1.0\text{mA} \leq I_O \leq 40\text{mA}$			<b>0.1</b>	
Output Noise Voltage	$N_O$	$10\text{Hz} \leq f \leq 100\text{kHz}$ (Note 3)		80		$\mu\text{V}$
Ripple Rejection	$\Delta V_I / \Delta V_O$	$f = 120\text{Hz}$ , $15\text{V} \leq V_I \leq 18\text{V}$	40	54		dB
Peak Output Current	$I_{PK}$			150		mA
Average Temperature Coefficient of Output Voltage	$\Delta V_O / \Delta T$	$I_O = 5.0\text{mA}$		-1.0		mV/ $^\circ\text{C}$
Minimum Value of Input Voltage Required to Maintain Line Regulation	$V_I(\text{Min})$			13.7		V

Note 2: Power Dissipation  $\leq 0.6\text{W}$

Note 3: Recommended minimum load capacitance of  $0.01\mu\text{F}$  to limit high frequency noise.



### 3-TERMINAL POSITIVE LINEAR REGULATOR

AZ78LXX

#### Typical Performance Characteristics



Figure 4. Dropout Characteristics

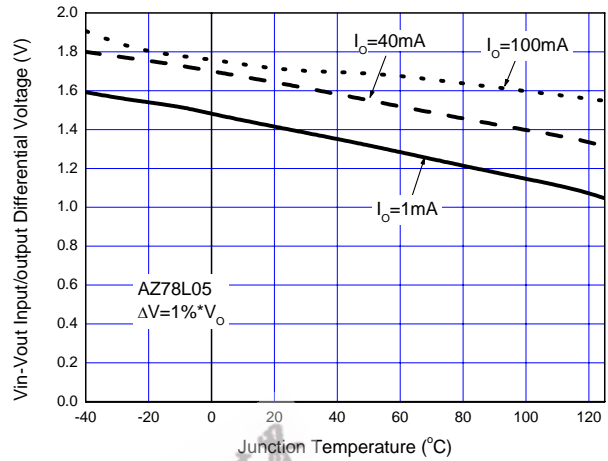

Figure 5. Dropout Voltage vs. Junction Temperature

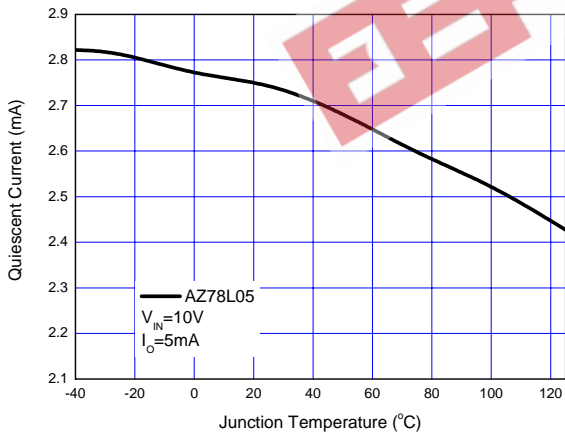

Figure 6. Quiescent Current vs. Junction Temperature

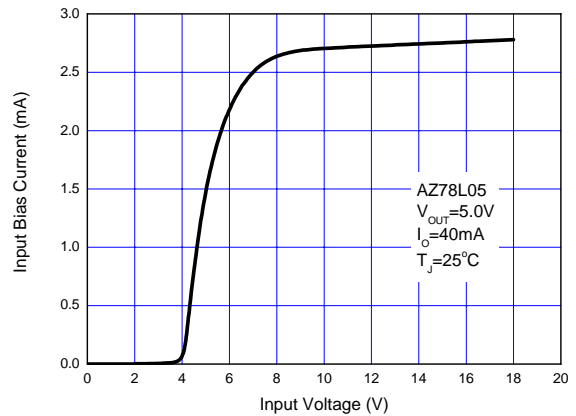

Figure 7. Input Bias Current vs. Input Voltage



**3-TERMINAL POSITIVE LINEAR REGULATOR**

**AZ78LXX**

**Typical Performance Characteristics (Continued)**

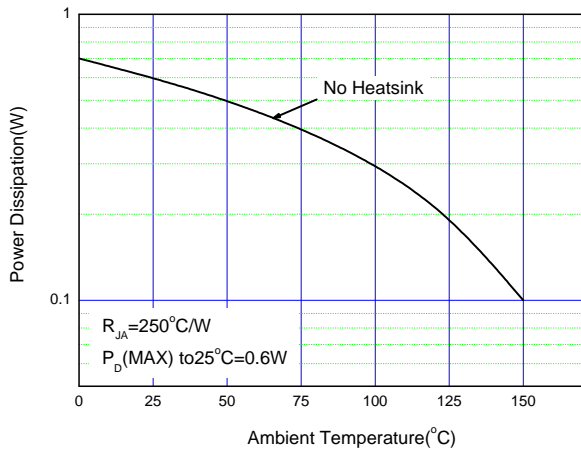

Figure 8. Maximum Power Dissipation vs. Ambient Temperature (SOIC-8 Package)

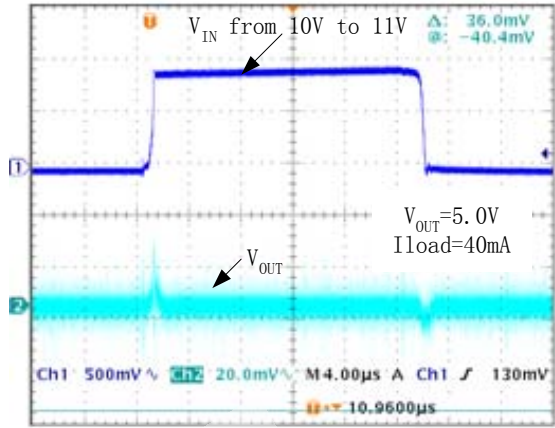

Figure 9. Line Transient Response

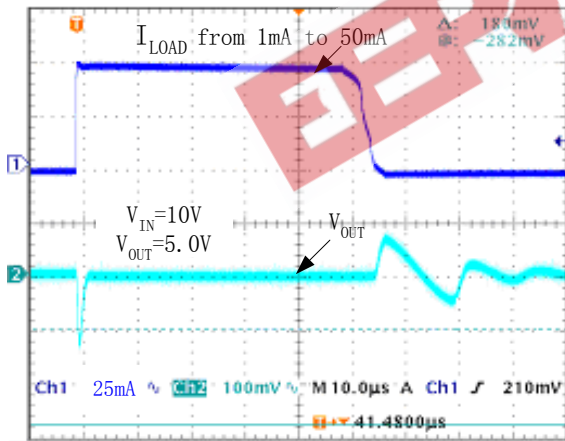

Figure 10. Load Transient Response



**3-TERMINAL POSITIVE LINEAR REGULATOR**

**AZ78LXX**

**Typical Application**

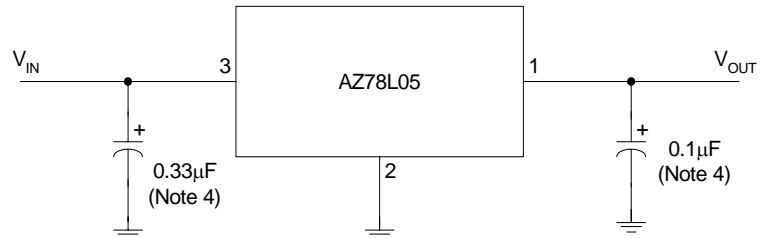

Note 4: Bypass capacitors are recommended for optimum stability and transient response and should be located as close as possible to the regulator.

Figure 11. Typical Application of the AZ78LXX





**3-TERMINAL POSITIVE LINEAR REGULATOR**

**AZ78LXX**

**Mechanical Dimensions**

**TO-92**

**Unit: mm(inch)**

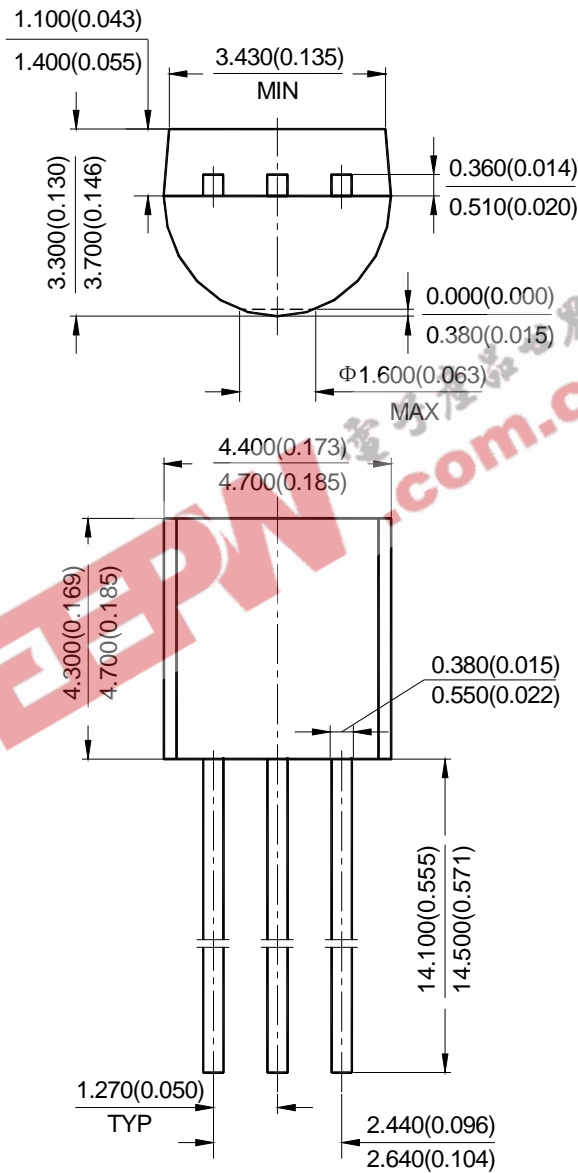





**3-TERMINAL POSITIVE LINEAR REGULATOR**

**AZ78LXX**

**Mechanical Dimensions (Continued):**

**SOT-223**

**Unit: mm(inch)**





**3-TERMINAL POSITIVE LINEAR REGULATOR**

**AZ78LXX**

**Mechanical Dimensions (Continued):**

**SOT-89**

**Unit: mm(inch)**

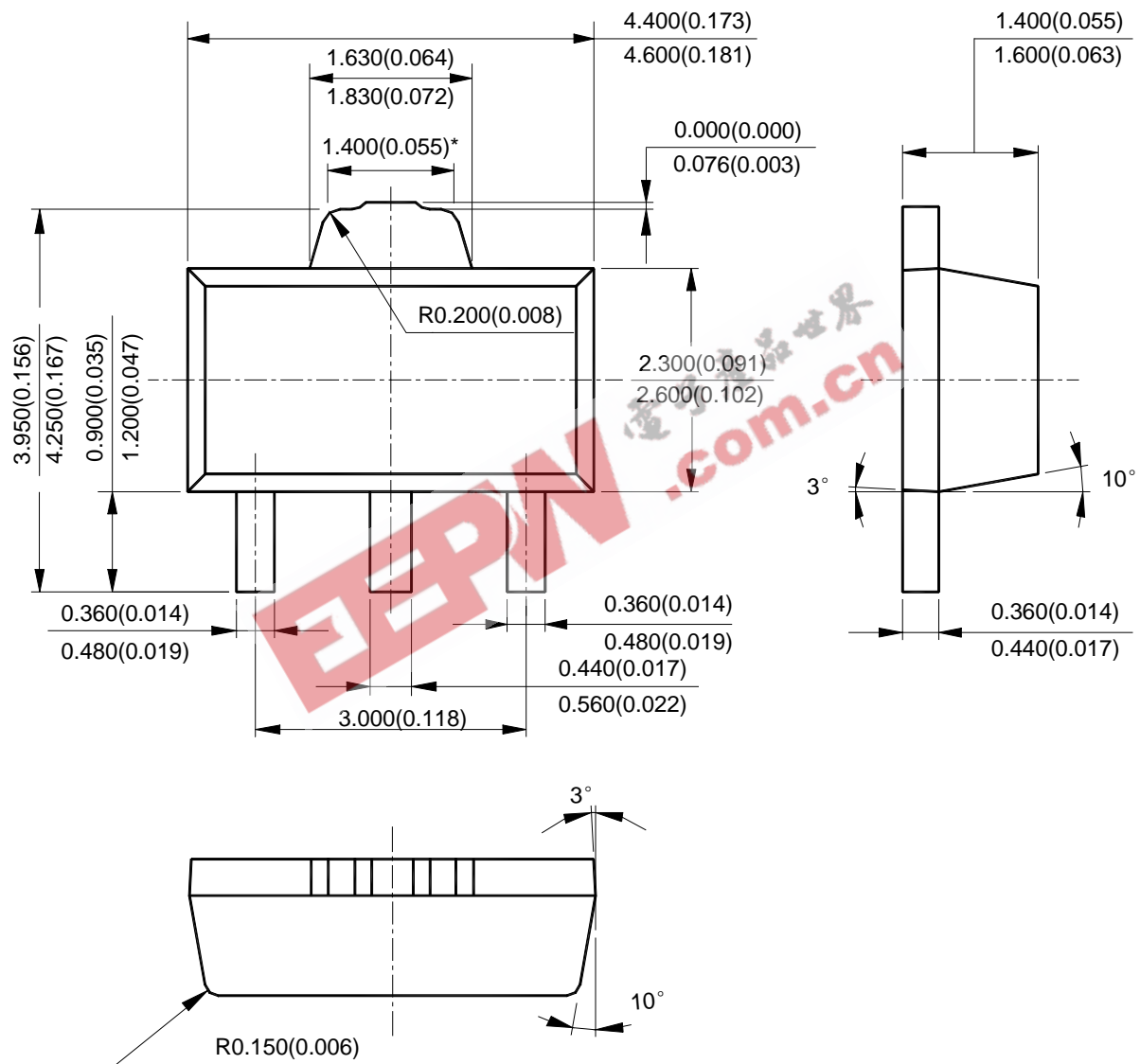





BCD Semiconductor Manufacturing Limited

<http://www.bcdsemi.com>

EEPW.com.cn  
电子世界

---

**BCD Semiconductor Corporation**

3170 De La Cruz Blvd, Suite # 105 Santa Clara, CA 95054-2411, U.S.A

Tel: +1-408-988 6388, Fax: +1-408-988 6386

**Shanghai SIM-BCD Semiconductor Manufacturing Co., Ltd.**

800 Yi Shan Road, Shanghai 200233, PRC

Tel: +86-21-6485-1491, Fax: +86-21-5450-0008

**Advanced Analog Circuits (Shanghai) Corporation**

8F, B Zone, 900 Yi Shan Road, Shanghai 200233, PRC

Tel: +86-21-6495 9539, Fax: +86-21-6485 9673

**BCD Semiconductor (Taiwan) Company Limited**

Room 2210, 22nd Fl, 333, Keelung Road, Sec. 1, TaiPei (110), Taiwan

Tel: +886-2-2758 6828, Fax: +886-2-2758 6892

**IMPORTANT NOTICE**

BCD Semiconductor Manufacturing Limited reserves the right to make changes without further notice to any products or specifications herein. BCD Semiconductor Manufacturing Limited does not assume any responsibility for use of any its products for any particular purpose, nor does BCD Semiconductor Manufacturing Limited assume any liability arising out of the application or use of any its products or circuits. BCD Semiconductor Manufacturing Limited does not convey any license under its patent rights or other rights nor the rights of others.