



LM323, A

Positive Voltage Regulators

The LM323,A are monolithic integrated circuits which supply a fixed positive 5.0 V output with a load driving capability in excess of 3.0 A. These three-terminal regulators employ internal current limiting, thermal shutdown, and safe-area compensation. The A-suffix is an improved device with superior electrical characteristics and a 2% output voltage tolerance. These regulators are offered with a 0° to +125°C temperature range in a low cost plastic power package.

Although designed primarily as a fixed voltage regulator, these devices can be used with external components to obtain adjustable voltages and currents. These devices can be used with a series pass transistor to supply up to 15 A at 5.0 V.

- Output Current in Excess of 3.0 A
- Available with 2% Output Voltage Tolerance
- No External Components Required
- Internal Thermal Overload Protection
- Internal Short Circuit Current Limiting
- Output Transistor Safe-Area Compensation
- Thermal Regulation and Ripple Rejection Have Specified Limits

3-AMPERE, 5 VOLT POSITIVE VOLTAGE REGULATORS

SEMICONDUCTOR TECHNICAL DATA

T SUFFIX
PLASTIC PACKAGE
CASE 221A

Pin 1. Input
2. Ground
3. Output

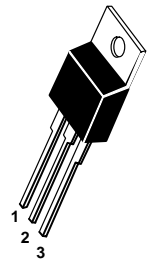

Heatsink surface is connected to Pin 2.

Simplified Application

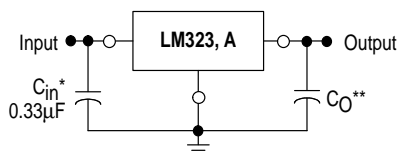

A common ground is required between the input and the output voltages. The input voltage must remain typically 2.5V above the output voltage even during the low point on the input ripple voltage.

* C_{in} is required if regulator is located an appreciable distance from power supply filter. (See Applications Information for details.)

** C_O is not needed for stability; however, it does improve transient response.

ORDERING INFORMATION

Device	Output Voltage Tolerance	Operating Temperature Range	Package
LM323T	4%	$T_J = 0^\circ \text{ to } +125^\circ \text{C}$	Plastic Power
LM323AT	2%		

LM323, A

MAXIMUM RATINGS

Rating	Symbol	Value	Unit
Input Voltage	V_{in}	20	Vdc
Power Dissipation	P_D	Internally Limited	W
Operating Junction Temperature Range	T_J	0 to +125	°C
Storage Temperature Range	T_{stg}	-65 to +150	°C
Lead Temperature (Soldering, 10 s)	T_{solder}	300	°C

ELECTRICAL CHARACTERISTICS ($T_J = T_{low}$ to T_{high} [Note 1], unless otherwise noted.)

Characteristics	Symbol	LM323A			LM323			Unit
		Min	Typ	Max	Min	Typ	Max	
Output Voltage ($V_{in} = 7.5\text{ V}$, $0 \leq I_{out} \leq 3.0\text{ A}$, $T_J = 25^\circ\text{C}$)	V_O	4.9	5.0	5.1	4.8	5.0	5.2	V
Output Voltage ($7.5\text{ V} \leq V_{in} \leq 15\text{ V}$, $0 \leq I_{out} \leq 3.0\text{ A}$, $P \leq P_{max}$) (Note 2)	V_O	4.8	5.0	5.2	4.75	5.0	5.25	V
Line Regulation ($7.5\text{ V} \leq V_{in} \leq 15\text{ V}$, $T_J = 25^\circ\text{C}$) (Note 3)	Reg _{line}	–	1.0	15	–	1.0	25	mV
Load Regulation ($V_{in} = 7.5\text{ V}$, $0 \leq I_{out} \leq 3.0\text{ A}$, $T_J = 25^\circ\text{C}$) (Note 3)	Reg _{load}	–	10	50	–	10	100	mV
Thermal Regulation (Pulse = 10 ms, $P = 20\text{ W}$, $T_A = 25^\circ\text{C}$)	Reg _{therm}	–	0.001	0.01	–	0.002	0.03	% V_O /W
Quiescent Current ($7.5\text{ V} \leq V_{in} \leq 15\text{ V}$, $0 \leq I_{out} \leq 3.0\text{ A}$)	I_B	–	3.5	10	–	3.5	20	mA
Output Noise Voltage ($10\text{ Hz} \leq f \leq 100\text{ kHz}$, $T_J = 25^\circ\text{C}$)	V_N	–	40	–	–	40	–	μV_{rms}
Ripple Rejection ($8.0\text{ V} \leq V_{in} \leq 18\text{ V}$, $I_{out} = 2.0\text{ A}$, $f = 120\text{ Hz}$, $T_J = 25^\circ\text{C}$)	RR	66	75	–	62	75	–	dB
Short Circuit Current Limit ($V_{in} = 15\text{ V}$, $T_J = 25^\circ\text{C}$) ($V_{in} = 7.5\text{ V}$, $T_J = 25^\circ\text{C}$)	I_{SC}	–	4.5	–	–	4.5	–	A
Long Term Stability	S	–	–	35	–	–	35	mV
Thermal Resistance, Junction-to-Case (Note 4)	$R_{\theta JC}$	–	2.0	–	–	2.0	–	°C/W

NOTES: 1. T_{low} to $T_{high} = 0^\circ$ to $+125^\circ\text{C}$

2. Although power dissipation is internally limited, specifications apply only for $P \leq P_{max} = 25\text{ W}$.

3. Load and line regulation are specified at constant junction temperature. Pulse testing is required with a pulse width $\leq 1.0\text{ ms}$ and a duty cycle $\leq 5\%$.

4. Without a heatsink, the thermal resistance ($R_{\theta JA}$ is 65°C/W). With a heatsink, the effective thermal resistance can approach the specified values of 2.0°C/W , depending on the efficiency of the heatsink.

LM323, A

Representative Schematic Diagram

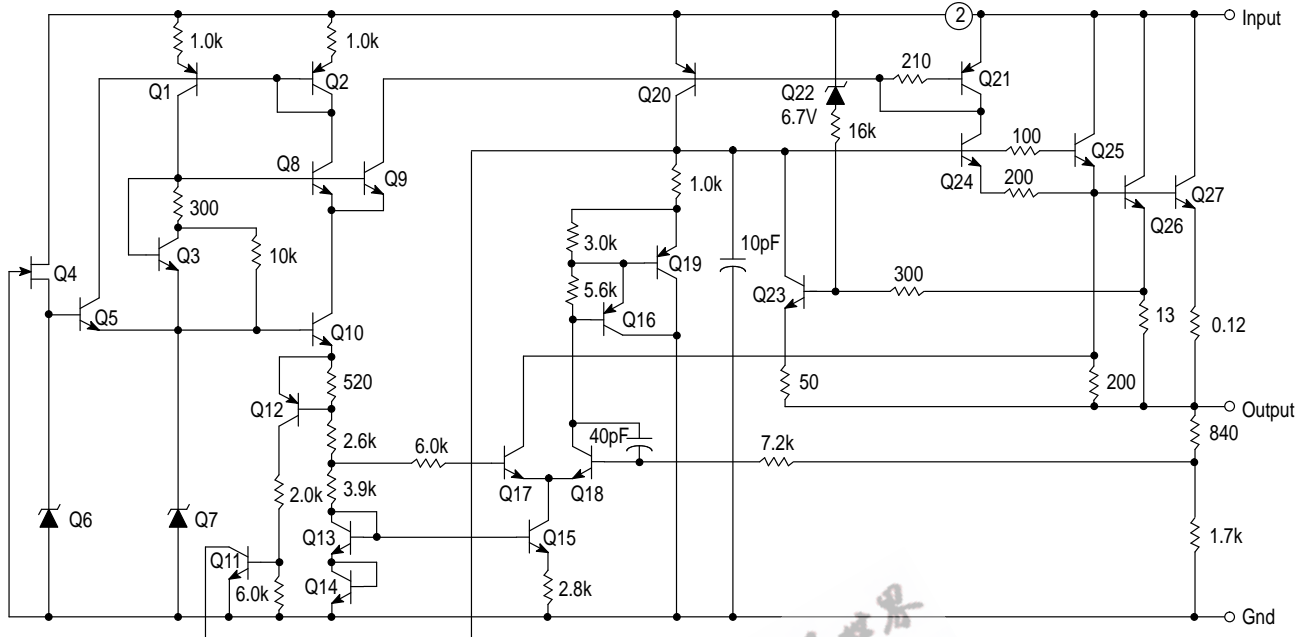

VOLTAGE REGULATOR PERFORMANCE

The performance of a voltage regulator is specified by its immunity to changes in load, input voltage, power dissipation, and temperature. Line and load regulation are tested with a pulse of short duration ($< 100 \mu\text{s}$) and are strictly a function of electrical gain. However, pulse widths of longer duration ($> 1.0 \text{ ms}$) are sufficient to affect temperature gradients across the die. These temperature gradients can cause a change in the output voltage, in addition to changes by line and load regulation. Longer pulse widths and thermal gradients make it desirable to specify thermal regulation.

Thermal regulation is defined as the change in output voltage caused by a change in dissipated power for a specified time, and is expressed as a percentage output voltage change per watt. The change in dissipated power can

be caused by a change in either input voltage or the load current. Thermal regulation is a function of IC layout and die attach techniques, and usually occurs within 10 ms of a change in power dissipation. After 10 ms, additional changes in the output voltage are due to the temperature coefficient of the device.

Figure 1 shows the line and thermal regulation response of a typical LM323A to a 20 W input pulse. The variation of the output voltage due to line regulation is labeled Δ and the thermal regulation component is labeled Δ . Figure 2 shows the load and thermal regulation response of a typical LM323A to a 20 W load pulse. The output voltage variation due to load regulation is labeled Δ and the thermal regulation component is labeled Δ .

Figure 1. Line and Thermal Regulation

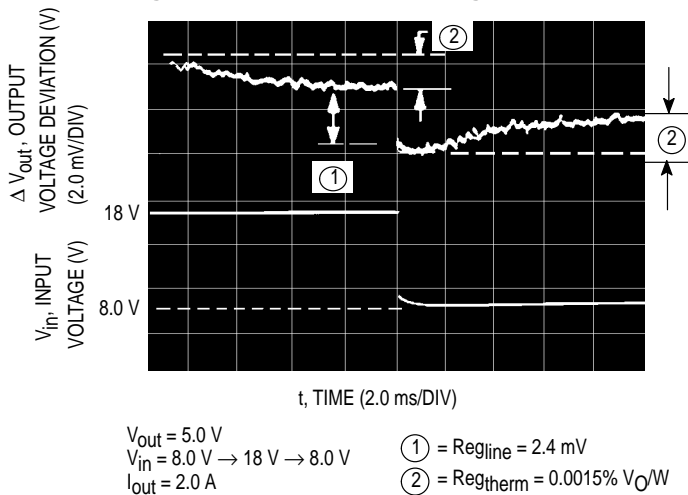
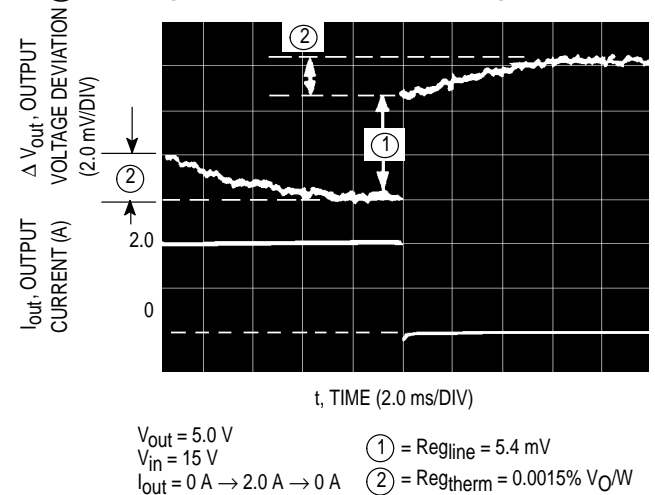

Figure 2. Load and Thermal Regulation



LM323, A

Figure 3. Temperature Stability

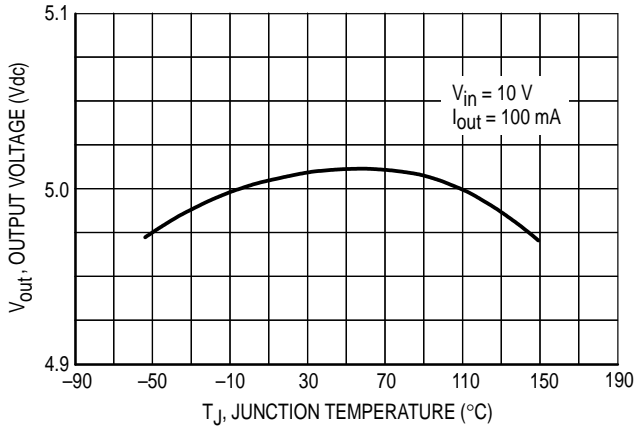

Figure 4. Output Impedance

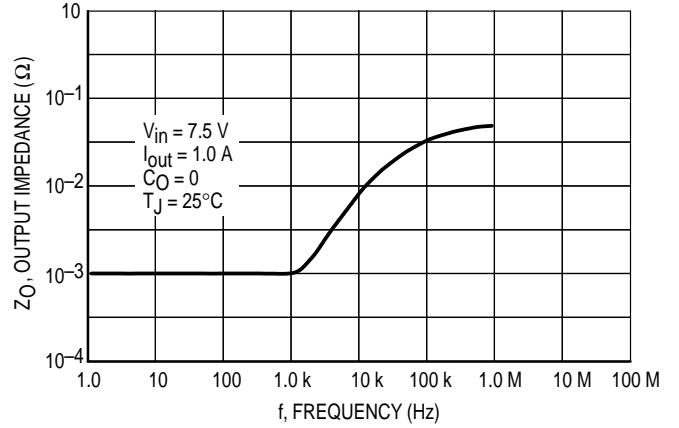

Figure 5. Ripple Rejection versus Frequency

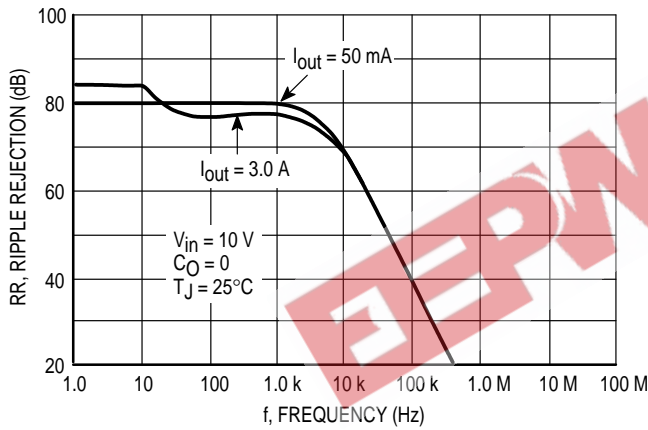

Figure 6. Ripple Rejection versus Output Current

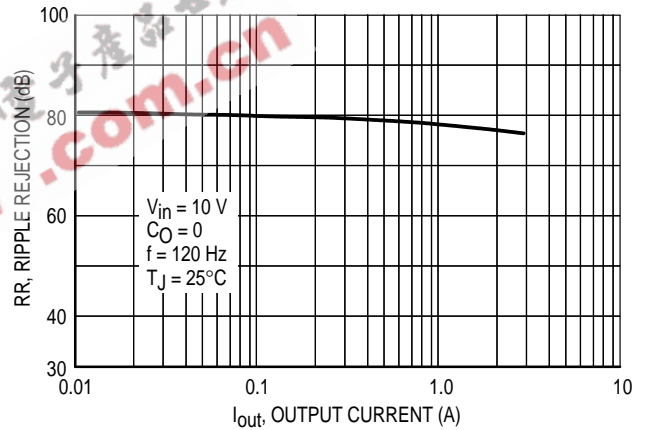

Figure 7. Quiescent Current versus Input Voltage

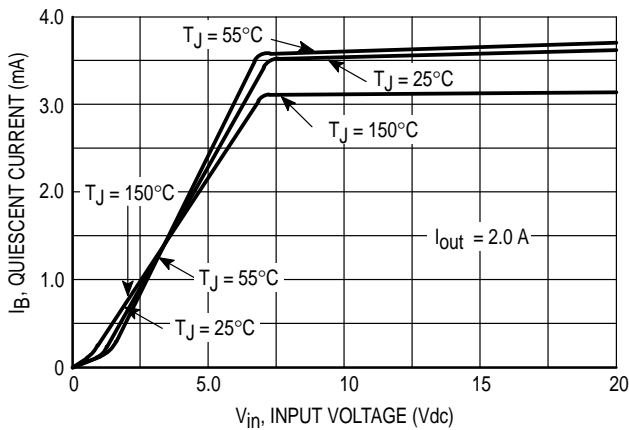
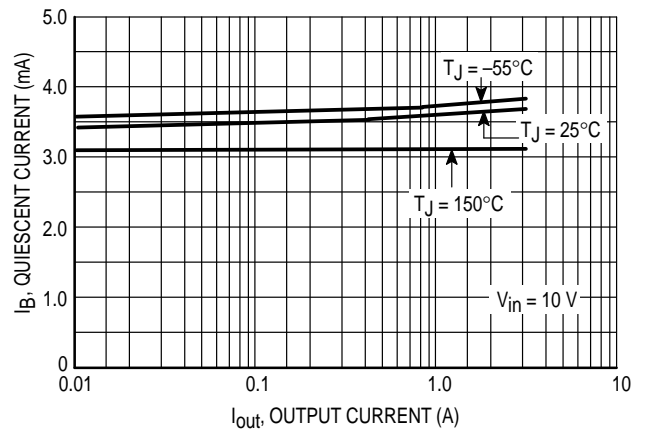

Figure 8. Quiescent Current versus Output Current



LM323, A

Figure 9. Dropout Voltage

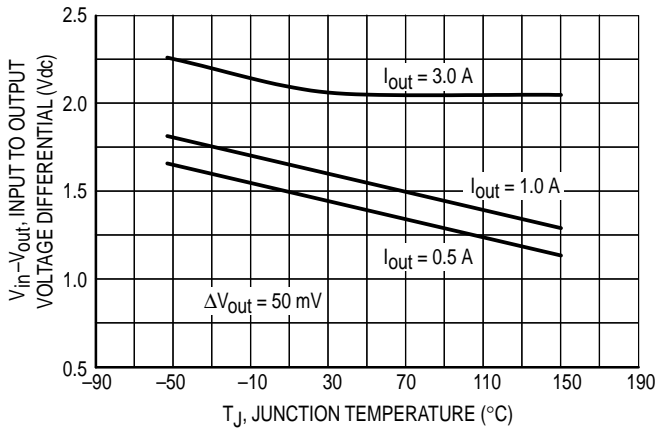

Figure 10. Short Circuit Current

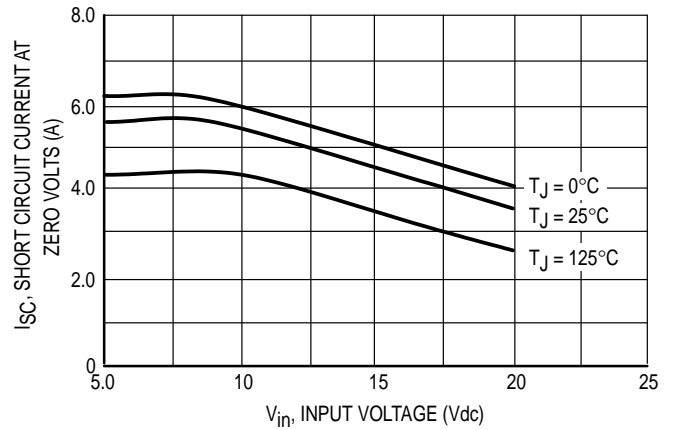

Figure 11. Line Transient Response

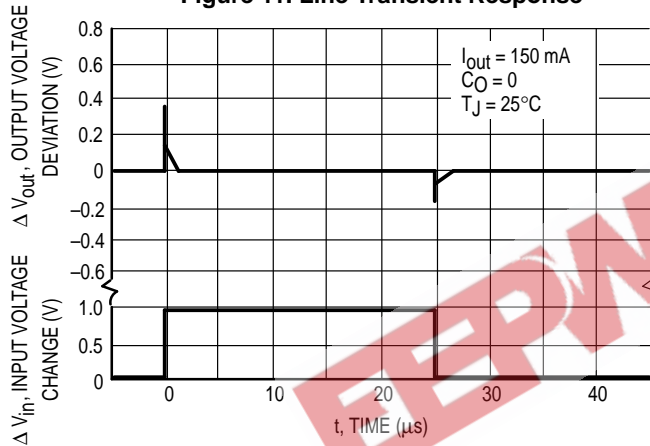
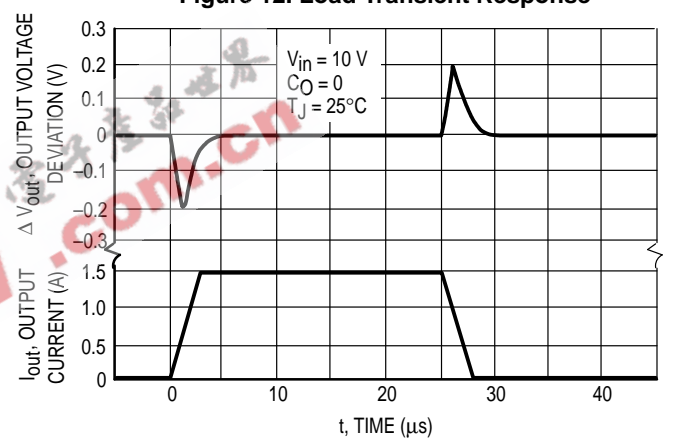

Figure 12. Load Transient Response



APPLICATIONS INFORMATION

Design Considerations

The LM323,A series of fixed voltage regulators are designed with Thermal Overload Protection that shuts down the circuit when subjected to an excessive power overload condition, Internal Short Circuit Protection that limits the maximum current the circuit will pass, and Output Transistor Safe-Area Compensation that reduces the output short circuit current as the voltage across the pass transistor is increased.

In many low current applications, compensation capacitors are not required. However, it is recommended that the regulator input be bypassed with a capacitor if the

regulator is connected to the power supply filter with long wire lengths, or if the output load capacitance is large. An input bypass capacitor should be selected to provide good high-frequency characteristics to insure stable operation under all load conditions. A 0.33 μF or larger tantalum, mylar, or other capacitor having low internal impedance at high frequencies should be chosen. The bypass capacitor should be mounted with the shortest possible leads directly across the regulator's input terminals. Normally good construction techniques should be used to minimize ground loops and lead resistance drops since the regulator has no external sense lead.

LM323, A

Figure 13. Current Regulator

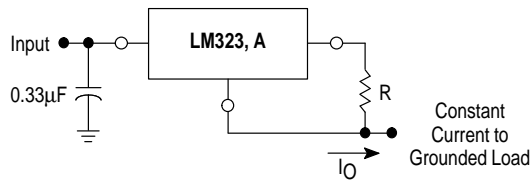

The LM323, A regulator can also be used as a current source when connected as above. Resistor R determines the current as follows:

$$I_O = \frac{5.0 \text{ V}}{R} + I_B$$

$\Delta I_B \cong 0.7 \text{ mA}$ over line, load and temperature changes
 $I_B \cong 3.5 \text{ mA}$

For example, a 2.0 A current source would require R to be a 2.5 Ω , 15 W resistor and the output voltage compliance would be the input voltage less 7.5 V.

Figure 14. Adjustable Output Regulator

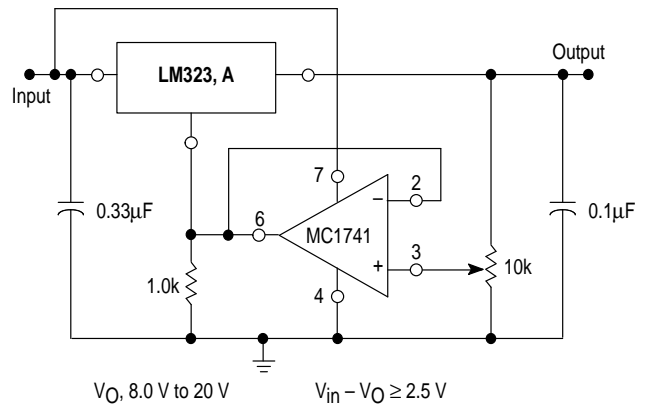

The addition of an operational amplifier allows adjustment to higher or intermediate values while retaining regulation characteristics. The minimum voltage obtainable with this arrangement is 3.0 V greater than the regulator voltage.

Figure 15. Current Boost Regulator

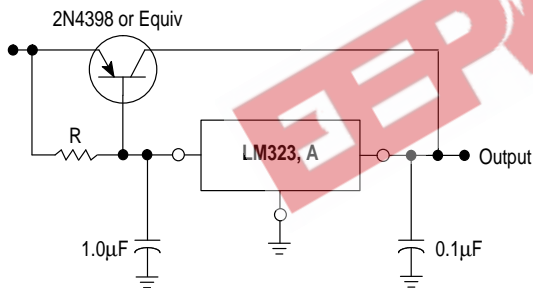

The LM323, A series can be current boosted with a PNP transistor. The 2N4398 provides current to 15 A. Resistor R in conjunction with the V_{BE} of the PNP determines when the pass transistor begins conducting; this circuit is not short circuit proof. Input-output differential voltage minimum is increased by the V_{BE} of the pass transistor.

Figure 16. Current Boost with Short Circuit Protection

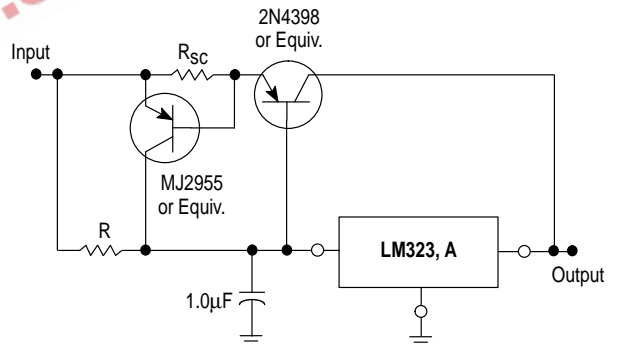

The circuit of Figure 16 can be modified to provide supply protection against short circuits by adding a short circuit sense resistor, R_{SC} , and an additional PNP transistor. The current sensing PNP must be able to handle the short circuit current of the three-terminal regulator. Therefore, an 8.0 A power transistor is specified.

LM323, A OUTLINE DIMENSIONS

T SUFFIX
PLASTIC PACKAGE
CASE 221A-06
ISSUE Y

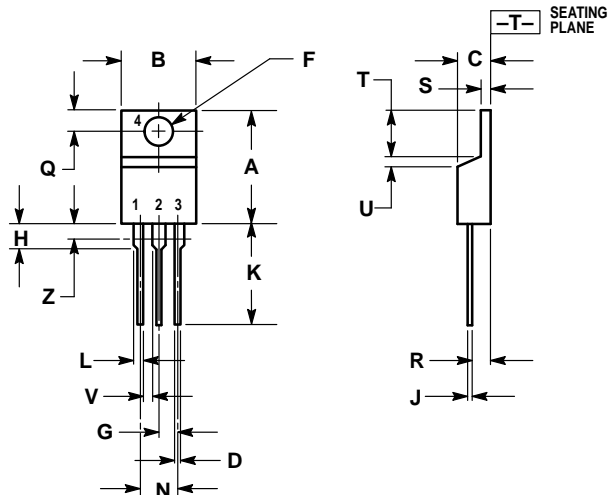

- NOTES:
1. DIMENSIONING AND TOLERANCING PER ANSI Y14.5M, 1982.
 2. CONTROLLING DIMENSION: INCH.
 3. DIMENSION Z DEFINES A ZONE WHERE ALL BODY AND LEAD IRREGULARITIES ARE ALLOWED.

DIM	INCHES		MILLIMETERS	
	MIN	MAX	MIN	MAX
A	0.570	0.620	14.48	15.75
B	0.380	0.405	9.66	10.28
C	0.160	0.190	4.07	4.82
D	0.025	0.035	0.64	0.88
F	0.142	0.147	3.61	3.73
G	0.095	0.105	2.42	2.66
H	0.110	0.155	2.80	3.93
J	0.018	0.025	0.46	0.64
K	0.500	0.562	12.70	14.27
L	0.045	0.060	1.15	1.52
N	0.190	0.210	4.83	5.33
Q	0.100	0.120	2.54	3.04
R	0.080	0.110	2.04	2.79
S	0.045	0.055	1.15	1.39
T	0.235	0.255	5.97	6.47
U	0.000	0.050	0.00	1.27
V	0.045	—	1.15	—
Z	—	0.080	—	2.04

EEPW.com.cn

电子產品世界

LM323, A

EEPW 电子产品世界 .com.cn

Motorola reserves the right to make changes without further notice to any products herein. Motorola makes no warranty, representation or guarantee regarding the suitability of its products for any particular purpose, nor does Motorola assume any liability arising out of the application or use of any product or circuit, and specifically disclaims any and all liability, including without limitation consequential or incidental damages. "Typical" parameters which may be provided in Motorola data sheets and/or specifications can and do vary in different applications and actual performance may vary over time. All operating parameters, including "Typicals" must be validated for each customer application by customer's technical experts. Motorola does not convey any license under its patent rights nor the rights of others. Motorola products are not designed, intended, or authorized for use as components in systems intended for surgical implant into the body, or other applications intended to support or sustain life, or for any other application in which the failure of the Motorola product could create a situation where personal injury or death may occur. Should Buyer purchase or use Motorola products for any such unintended or unauthorized application, Buyer shall indemnify and hold Motorola and its officers, employees, subsidiaries, affiliates, and distributors harmless against all claims, costs, damages, and expenses, and reasonable attorney fees arising out of, directly or indirectly, any claim of personal injury or death associated with such unintended or unauthorized use, even if such claim alleges that Motorola was negligent regarding the design or manufacture of the part. Motorola and  registered trademarks of Motorola, Inc. Motorola, Inc. is an Equal Opportunity/Affirmative Action Employer.

How to reach us:

USA/EUROPE/Locations Not Listed: Motorola Literature Distribution;
P.O. Box 20912; Phoenix, Arizona 85036. 1-800-441-2447 or 602-303-5454

MFAX: RMFAX0@email.sps.mot.com – TOUCHTONE 602-244-6609
INTERNET: <http://Design-NET.com>

JAPAN: Nippon Motorola Ltd.; Tatsumi-SPD-JLDC, 6F Seibu-Butsuryu-Center,
3-14-2 Tatsumi Koto-Ku, Tokyo 135, Japan. 03-81-3521-8315

ASIA/PACIFIC: Motorola Semiconductors H.K. Ltd.; 8B Tai Ping Industrial Park,
51 Ting Kok Road, Tai Po, N.T., Hong Kong. 852-26629298



MOTOROLA



LM323/D

