

LM78L00 Series 3-Terminal Low Current Positive Voltage Regulators



THREE-TERMINAL LOW CURRENT POSITIVE VOLTAGE REGULATORS

The LM78L00 Series of positive voltage regulators are inexpensive, easy-to-use devices suitable for a multitude of applications that require a regulated supply of up to 100 mA. Like their higher powered LM7800 Series cousins, these regulators feature internal current limiting and thermal shutdown making them remarkably rugged. No external components are required with the LM78L00 devices in many applications.

These devices offer a substantial performance advantage over the traditional zener diode-resistor combination, as output impedance and quiescent current are substantially reduced.

FEATURES

- Wide Range of Available, Fixed Output Voltages
- Low Cost
- Internal Short Circuit Current Limiting
- Internal Thermal Overload Protection
- No External Components Required
- Complementary Negative Regulators Offered
- Available in $\pm 2\%$ Voltage Tolerance.

CIRCUIT SCHEMATIC

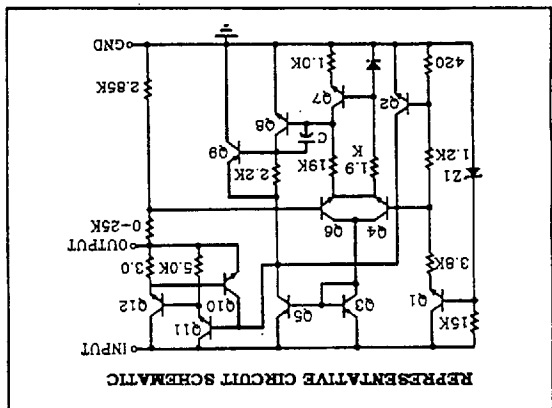

ORDERING INFORMATION

LM78L055	JUNCTION TEMPERATURE	PACKAGE
LM78L05	$T_J = 0^\circ\text{C}$ TO $+125^\circ\text{C}$	TO-92
SOP-8		

STANDARD APPLICATION

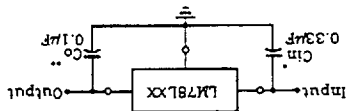

A common ground is required between the input and the output voltages. The input voltage must remain typically 2.0 V above the output voltage even during the low point on the input ripple voltage.

* C_{in} is required if regulator is located an appreciable distance from power supply filter.

** C_{o} is not needed for stability; however, it does improve transient response.

TYPICAL CONNECTING CIRCUIT

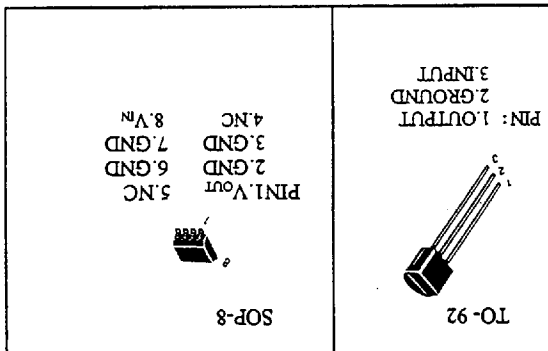

PIN ARRANGEMENT

LM78L00 Series 3-Terminal Low Current Positive Voltage Regulators



MAXIMUM RATINGS (Ta = 25°C unless otherwise noted.)

RATING	SYMBOL	VALUE	UNIT
Input Voltage	Vi	30	V
Storage Junction Temperature Range	Tsig	-65 TO +150	°C
Operating Junction Temperature Range	Tj	0 TO +125	°C

LM78L05/S ELECTRICAL CHARACTERISTICS :

(Vi = 10V, Io = 40mA, Ci = 0.33µF, Co = 0.1µF, 0°C < Tj < +125°C unless otherwise noted.)

CHARACTERISTIC	SYMBOL	MIN	TYP	MAX	UNIT
Output Voltage (Tj = +25°C)	Vo	4.9	5.0	5.1	Vdc
Line Regulation (Tj = +25°C, Io = 40mA) 7.0V ≤ Vi ≤ 20V 8.0V ≤ Vi ≤ 20V	REGline	55	44	200	mV
Load Regulation (Tj = +25°C, Io = 100mA Tj = +25°C, Io = 40mA)	REGload	11	5.0	60	mV
Output Voltage 7.0V ≤ Vi ≤ 20V, Io ≤ 40mA Vi = 10V, Io ≤ 70mA	Vo	4.9		5.1	Vdc
Input Bias Current (Tj = +25°C)	Ib	3.8		6.0	mA
Input Bias Current Change 8.0V ≤ Vi ≤ 20V Io ≤ 40mA	Δ Ib			1.5	mA
Output Noise Voltage (Ta = +25°C, 10Hz ≤ f ≤ 100KHz)	Vn	40			µV
Ripple Rejection (Io = 40mA, f = 120Hz, 8.0V ≤ Vi ≤ 18V) (Tj = +25°C)	RR	40	49		dB
Dropout Voltage (Tj = +25°C)	Vi - Vo		1.7		Vdc

LM78L00 Series 3-Terminal Low Current Positive Voltage Regulators



LM78L08/S ELECTRICAL CHARACTERISTICS :

($V_i=14V$, $I_o=40mA$, $C_i=0.33\mu F$, $C_o=0.1\mu F$, $0^\circ C < T_j < +125^\circ C$ unless otherwise noted.)

CHARACTERISTIC	SYMBOL	MIN	TYP	MAX	UNIT
Output Voltage ($T_j=+25^\circ C$)	V_o	7.84	8.0	8.16	Vdc
Line Regulation ($T_j=+25^\circ C$, $I_o=40mA$)	REGline	20	12	200	mV
Load Regulation	REGload	15	6.0	80	mV
Output Voltage $10.5V \leq V_i \leq 23V$, $1.0mA \leq I_o \leq 40mA$ $V_i=14V$, $1.0mA \leq I_o \leq 70mA$	V_o	7.74	7.74	8.26	Vdc
Input Bias Current ($T_j=+25^\circ C$) ($T_j=+125^\circ C$)	I_b		3.0	6.0	mA
Input Bias Current Change $11V \leq V_i \leq 23V$ $1.0mA \leq I_o \leq 40mA$	ΔI_b			1.5	mA
Output Noise Voltage ($T_a=+25^\circ C$, $10Hz \leq f \leq 100KHz$)	V_n		52		μV
Ripple Rejection ($I_o=40mA$, $f=120Hz$, $12V \leq V_i \leq 23V$) ($T_j=+25^\circ C$)	RR	36		55	dB
Dropout Voltage ($T_j=+25^\circ C$)	V_i-V_o		1.7		Vdc

LM78L12/S ELECTRICAL CHARACTERISTICS :

($V_i=19V$, $I_o=40mA$, $C_i=0.33\mu F$, $C_o=0.1\mu F$, $0^\circ C < T_j < +125^\circ C$ unless otherwise noted.)

CHARACTERISTIC	SYMBOL	MIN	TYP	MAX	UNIT
Output Voltage ($T_j=+25^\circ C$)	V_o	11.76	12	12.24	Vdc
Line Regulation ($T_j=+25^\circ C$, $I_o=40mA$)	REGline	120	100	250	mV
Load Regulation	REGload	20	100	100	mV
Output Voltage $14.5V \leq V_i \leq 27V$, $1.0mA \leq I_o \leq 40mA$ $V_i=19V$, $1.0mA \leq I_o \leq 70mA$	V_o	11.66	11.66	12.34	Vdc
Input Bias Current ($T_j=+25^\circ C$) ($T_j=+125^\circ C$)	I_b		4.2	6.5	mA
Input Bias Current Change $16V \leq V_i \leq 27V$ $1.0mA \leq I_o \leq 40mA$	ΔI_b			1.5	mA
Output Noise Voltage ($T_a=+25^\circ C$, $10Hz \leq f \leq 100KHz$)	V_n		80		μV

LM78L00 Series 3-Terminal Low Current Positive Voltage Regulators



LM78L15/S ELECTRICAL CHARACTERISTICS :

($V_i=23V$, $I_o=40mA$, $C_i=0.33\mu F$, $C_o=0.1\mu F$, $f_c=0.1\mu F$, $f_r=0.01\mu F$, $f_c < T_j < +125^\circ C$ unless otherwise noted.)

CHARACTERISTIC	SYMBOL	MIN	TYP	MAX	UNIT
Output Voltage ($T_j=+25^\circ C$)	V_o	14.7	15	15.3	Vdc
Line Regulation ($T_j=+25^\circ C$, $I_o=40mA$)	REGline	130	110	300	mV
Load Regulation ($T_j=+25^\circ C$, $17.5V \leq V_i \leq 30V$)	REGload	25	12	150	mV
Output Voltage ($T_j=+25^\circ C$, $17.5V \leq V_i \leq 30V$, $1.0mA \leq I_o \leq 100mA$)					
Dropout Voltage ($T_j=+25^\circ C$)	$V_i - V_o$		1.7		Vdc
Ripple Rejection ($I_o=40mA$, $f=120Hz$, $18.5V \leq V_i \leq 28.5V$)	RR	33		39	dB
Output Noise Voltage ($T_j=+25^\circ C$, $10Hz \leq f \leq 100KHz$)	V_n		90		μV
Input Bias Current Change ($20V \leq V_i \leq 30V$)	ΔI_b			1.5	mA
Input Bias Current ($T_j=+25^\circ C$)	I_b		4.4	6.0	mA
Output Voltage ($T_j=+25^\circ C$, $17.5V \leq V_i \leq 30V$, $1.0mA \leq I_o \leq 40mA$)	V_o	14.55	14.55	15.45	Vdc
Load Regulation ($T_j=+25^\circ C$, $1.0mA \leq I_o \leq 40mA$)	REGload			75	mV
Line Regulation ($T_j=+25^\circ C$, $I_o=40mA$)	REGline			250	mV
Output Voltage ($T_j=+25^\circ C$)	V_o	17.64	18	18.36	Vdc
Line Regulation ($T_j=+25^\circ C$, $I_o=40mA$)	REGline	32	27	325	mV
Load Regulation ($T_j=+25^\circ C$, $1.0mA \leq I_o \leq 100mA$)	REGload	30	15	170	mV
Output Voltage ($T_j=+25^\circ C$, $21.4V \leq V_i \leq 33V$, $1.6mA \leq I_o \leq 40mA$)	V_o	17.44	17.44	18.56	Vdc
Input Bias Current ($T_j=+25^\circ C$)	I_b		3.1	6.5	mA
Input Bias Current Change ($22V \leq V_i \leq 33V$)	ΔI_b			1.5	mA
Output Noise Voltage ($T_j=+25^\circ C$, $10Hz \leq f \leq 100KHz$)	V_n			0.2	μV

LM78L18/S ELECTRICAL CHARACTERISTICS :

($V_i=27V$, $I_o=40mA$, $C_i=0.33\mu F$, $C_o=0.1\mu F$, $f_c=0.1\mu F$, $f_r=0.01\mu F$, $f_c < T_j < +125^\circ C$ unless otherwise noted.)

CHARACTERISTIC	SYMBOL	MIN	TYP	MAX	UNIT
Output Voltage ($T_j=+25^\circ C$)	V_o	17.64	18	18.36	Vdc
Line Regulation ($T_j=+25^\circ C$, $I_o=40mA$)	REGline	32	27	325	mV
Load Regulation ($T_j=+25^\circ C$, $1.0mA \leq I_o \leq 100mA$)	REGload	30	15	170	mV
Output Voltage ($T_j=+25^\circ C$, $21.4V \leq V_i \leq 33V$, $1.6mA \leq I_o \leq 40mA$)	V_o	17.44	17.44	18.56	Vdc
Input Bias Current ($T_j=+25^\circ C$)	I_b		3.1	6.5	mA
Input Bias Current Change ($22V \leq V_i \leq 33V$)	ΔI_b			1.5	mA
Output Noise Voltage ($T_j=+25^\circ C$, $10Hz \leq f \leq 100KHz$)	V_n			0.2	μV

LM78L00 Series 3-Terminal Low Current Positive Voltage Regulators



LM78L24/S ELECTRICAL CHARACTERISTICS :

($V_i=33V$, $I_o=40mA$, $C_i=0.33\mu F$, $C_o=0.1\mu F$, $0^\circ C < T_j < +125^\circ C$ unless otherwise noted.)

CHARACTERISTIC		SYMBOL	MIN	TYP	MAX	UNIT
Output Voltage	($T_j=+25^\circ C$)	V_o	23.52	24	24.48	Vdc
Line Regulation($T_j=+25^\circ C$, $I_o=40mA$)	$27.5V \leq V_i \leq 38V$ $28V \leq V_i \leq 38V$	REGLine		35	350	mV
Load Regulation	$T_j=+25^\circ C$, $1.0mA \leq I_o \leq 100mA$ $T_j=+25^\circ C$, $1.0mA \leq I_o \leq 40mA$	REGload		40	200	mV
Output Voltage	$28V \leq V_i \leq 38V$, $1.0mA \leq I_o \leq 40mA$ $28V \leq V_i \leq 33V$, $1.0mA \leq I_o \leq 70mA$	V_o	23.32		24.68	Vdc
Input Bias Current	($T_j=+25^\circ C$) ($T_j=+125^\circ C$)	I_{IB}		3.1	6.5	mA
Input Bias Current Change	$28V \leq V_i \leq 38V$ $1.0mA \leq I_o \leq 40mA$	ΔI_{IB}			1.5	mA
Output Noise Voltage	($T_a=+25^\circ C$, $10Hz \leq f \leq 100kHz$)	V_n		200		μV
Ripple Rejection	($I_o=40mA$, $f=120Hz$, $29V \leq V_i \leq 35V$, $T_j=+25^\circ C$)	RR	30	43		dB
Dropout Voltage ($T_j=+25^\circ C$)		V_i-V_o		1.7		Vdc

FIGURE 1-DROPOUT CHARACTERISTIC

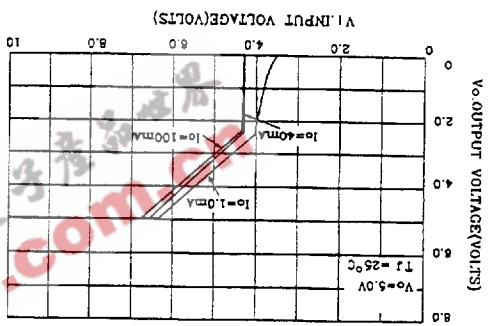

FIGURE 3-INPUT BIAS CURRENT versus AMBIENT TEMPERATURE

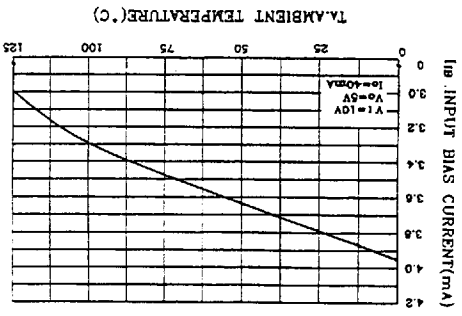

FIGURE 2-DROPOUT VOLTAGE versus JUNCTION TEMPERATURE

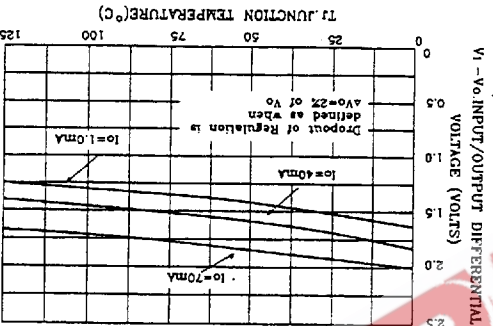

FIGURE 4-INPUT BIAS CURRENT versus INPUT VOLTAGE

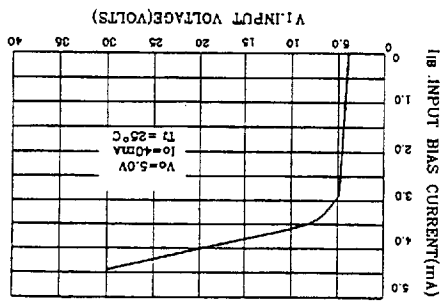

FIGURE 5-MAXIMUM AVERAGE POWER DISSIPATION versus AMBIENT TEMPERATURE - TO-92 Type Package

