

LM78LXX Series 3-Terminal Positive Regulators

General Description

The LM78LXX series of three terminal positive regulators is available with several fixed output voltages making them useful in a wide range of applications. When used as a zener diode/resistor combination replacement, the LM78LXX usually results in an effective output impedance improvement of two orders of magnitude, and lower quiescent current. These regulators can provide local on card regulation, eliminating the distribution problems associated with single point regulation. The voltages available allow the LM78LXX to be used in logic systems, instrumentation, HiFi, and other solid state electronic equipment.

The LM78LXX is available in the plastic TO-92 (Z) package, the plastic SO-8 (M) package and a chip sized package (8-Bump micro SMD) using National's micro SMD package technology. With adequate heat sinking the regulator can deliver 100mA output current. Current limiting is included to limit the peak output current to a safe value. Safe area protection for the output transistors is provided to limit inter-

nal power dissipation. If internal power dissipation becomes too high for the heat sinking provided, the thermal shutdown circuit takes over preventing the IC from overheating.

Features

- LM78L05 in micro SMD package
- Output voltage tolerances of $\pm 5\%$ over the temperature range
- Output current of 100mA
- Internal thermal overload protection
- Output transistor safe area protection
- Internal short circuit current limit
- Available in plastic TO-92 and plastic SO-8 low profile packages
- No external components
- Output voltages of 5.0V, 6.2V, 8.2V, 9.0V, 12V, 15V
- See AN-1112 for micro SMD considerations

Connection Diagrams

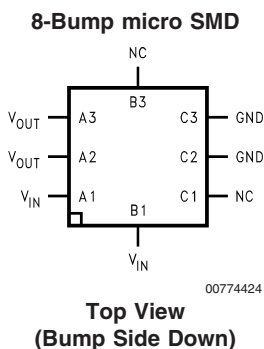
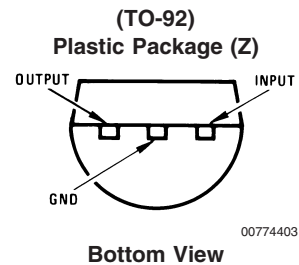
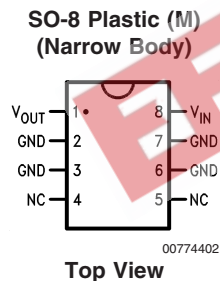

micro SMD Marking Orientation

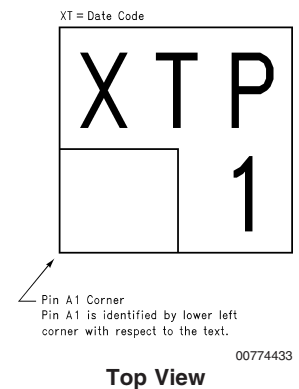

Ordering Information

Package	Order Number	Output Voltage	NSC Drawing	Supplied As
microSMD	LM78L05IBP	5V	BPA08AAB	Reel of 250
	LM78L05IBPX	5V	BPA08AAB	Reel of 3000
	LM78L09ITP	9V	TPA08AAA	Reel of 250
	LM78L09ITPX	9V	TPA08AAA	Reel of 3000
SOIC Narrow	LM78L05ACM	5V	M08A	Rail of 95
	LM78L05ACMX	5V	M08A	Reel of 2500
	LM78L12ACM	12V	M08A	Rail of 95
	LM78L12ACMX	12V	M08A	Reel of 2500
	LM78L15ACM	15V	M08A	Rail of 95
	LM78L15ACMX	15V	M08A	Reel of 2500
TO-92	LM78L05ACZ	5V	Z03A	Box of 1800
	LM78L62ACZ	6.2V	Z03A	Box of 1800
	LM78L82ACZ	8.2V	Z03A	Box of 1800
	LM78L09ACZ	9V	Z03A	Box of 1800
	LM78L12ACZ	12V	Z03A	Box of 1800
	LM78L15ACZ	15V	Z03A	Box of 1800

EEPW 电子产品世界
www.eepw.com.cn

Absolute Maximum Ratings (Note 1)

If Military/Aerospace specified devices are required, please contact the National Semiconductor Sales Office/Distributors for availability and specifications.

Power Dissipation (Note 5)	Internally Limited
Input Voltage	35V
Storage Temperature	-65°C to +150°C
ESD Susceptibility (Note 2)	1kV

Operating Junction Temperature

SO-8, TO-92	0°C to 125°C
micro SMD	-40°C to 85°C

Soldering Information

Infrared or Convection (20 sec.)	235°C
Wave Soldering (10 sec.)	260°C (lead time)

LM78LXX Electrical Characteristics Limits in standard typeface are for $T_J = 25^\circ\text{C}$, **Bold typeface applies over 0°C to 125°C for SO-8 and TO-92 packages, and -40°C to 85°C for micro SMD package.** Limits are guaranteed by production testing or correlation techniques using standard Statistical Quality Control (SQC) methods. Unless otherwise specified: $I_O = 40\text{mA}$, $C_I = 0.33\mu\text{F}$, $C_O = 0.1\mu\text{F}$.

LM78L05

Unless otherwise specified, $V_{IN} = 10\text{V}$

Symbol	Parameter	Conditions	Min	Typ	Max	Units
V_O	Output Voltage		4.8	5	5.2	V
		$7\text{V} \leq V_{IN} \leq 20\text{V}$ $1\text{mA} \leq I_O \leq 40\text{mA}$ (Note 3)	4.75		5.25	
		$1\text{mA} \leq I_O \leq 70\text{mA}$ (Note 3)	4.75		5.25	
ΔV_O	Line Regulation	$7\text{V} \leq V_{IN} \leq 20\text{V}$		18	75	mV
		$8\text{V} \leq V_{IN} \leq 20\text{V}$		10	54	
ΔV_O	Load Regulation	$1\text{mA} \leq I_O \leq 100\text{mA}$		20	60	mV
		$1\text{mA} \leq I_O \leq 40\text{mA}$		5	30	
I_Q	Quiescent Current			3	5	mA
ΔI_Q	Quiescent Current Change	$8\text{V} \leq V_{IN} \leq 20\text{V}$ $1\text{mA} \leq I_O \leq 40\text{mA}$			1.0 0.1	
V_n	Output Noise Voltage	$f = 10\text{ Hz to } 100\text{ kHz}$ (Note 4)		40		μV
$\frac{\Delta V_{IN}}{\Delta V_{OUT}}$	Ripple Rejection	$f = 120\text{ Hz}$ $8\text{V} \leq V_{IN} \leq 16\text{V}$	47	62		dB
I_{PK}	Peak Output Current			140		mA
$\frac{\Delta V_O}{\Delta T}$	Average Output Voltage Tempco	$I_O = 5\text{mA}$		-0.65		$\text{mV}/^\circ\text{C}$
$V_{IN}(\text{Min})$	Minimum Value of Input Voltage Required to Maintain Line Regulation			6.7	7	V
θ_{JA}	Thermal Resistance (8-Bump micro SMD)			230.9		$^\circ\text{C}/\text{W}$

LM78L62AC

Unless otherwise specified, $V_{IN} = 12\text{V}$

Symbol	Parameter	Conditions	Min	Typ	Max	Units
V_O	Output Voltage		5.95	6.2	6.45	V
		$8.5\text{V} \leq V_{IN} \leq 20\text{V}$ $1\text{mA} \leq I_O \leq 40\text{mA}$ (Note 3)	5.9		6.5	
		$1\text{mA} \leq I_O \leq 70\text{mA}$ (Note 3)	5.9		6.5	

LM78LXX Electrical Characteristics Limits in standard typeface are for $T_J = 25^\circ\text{C}$, **Bold typeface applies over 0°C to 125°C for SO-8 and TO-92 packages, and -40°C to 85°C for micro SMD package.** Limits are guaranteed by production testing or correlation techniques using standard Statistical Quality Control (SQC) methods. Unless otherwise specified: $I_O = 40\text{mA}$, $C_I = 0.33\mu\text{F}$, $C_O = 0.1\mu\text{F}$. (Continued)

LM78L62AC (Continued)

Unless otherwise specified, $V_{IN} = 12\text{V}$

Symbol	Parameter	Conditions	Min	Typ	Max	Units
ΔV_O	Line Regulation	$8.5\text{V} \leq V_{IN} \leq 20\text{V}$		65	175	mV
		$9\text{V} \leq V_{IN} \leq 20\text{V}$		55	125	
ΔV_O	Load Regulation	$1\text{mA} \leq I_O \leq 100\text{mA}$		13	80	mV
		$1\text{mA} \leq I_O \leq 40\text{mA}$		6	40	
I_Q	Quiescent Current			2	5.5	mA
ΔI_Q	Quiescent Current Change	$8\text{V} \leq V_{IN} \leq 20\text{V}$			1.5	mA
		$1\text{mA} \leq I_O \leq 40\text{mA}$			0.1	
V_n	Output Noise Voltage	$f = 10\text{ Hz to } 100\text{ kHz}$ (Note 4)		50		μV
$\frac{\Delta V_{IN}}{\Delta V_{OUT}}$	Ripple Rejection	$f = 120\text{ Hz}$ $10\text{V} \leq V_{IN} \leq 20\text{V}$	40	46		dB
I_{PK}	Peak Output Current			140		mA
$\frac{\Delta V_O}{\Delta T}$	Average Output Voltage Tempco	$I_O = 5\text{mA}$		-0.75		$\text{mV}/^\circ\text{C}$
$V_{IN}(\text{Min})$	Minimum Value of Input Voltage Required to Maintain Line Regulation			7.9		V

LM78L82AC

Unless otherwise specified, $V_{IN} = 14\text{V}$

Symbol	Parameter	Conditions	Min	Typ	Max	Units
V_O	Output Voltage		7.87	8.2	8.53	V
		$11\text{V} \leq V_{IN} \leq 23\text{V}$ $1\text{mA} \leq I_O \leq 40\text{mA}$ (Note 3)	7.8		8.6	
		$1\text{mA} \leq I_O \leq 70\text{mA}$ (Note 3)	7.8		8.6	
ΔV_O	Line Regulation	$11\text{V} \leq V_{IN} \leq 23\text{V}$		80	175	mV
		$12\text{V} \leq V_{IN} \leq 23\text{V}$		70	125	
ΔV_O	Load Regulation	$1\text{mA} \leq I_O \leq 100\text{mA}$		15	80	mV
		$1\text{mA} \leq I_O \leq 40\text{mA}$		8	40	
I_Q	Quiescent Current			2	5.5	mA
ΔI_Q	Quiescent Current Change	$12\text{V} \leq V_{IN} \leq 23\text{V}$			1.5	mA
		$1\text{mA} \leq I_O \leq 40\text{mA}$			0.1	
V_n	Output Noise Voltage	$f = 10\text{ Hz to } 100\text{ kHz}$ (Note 4)		60		μV
$\frac{\Delta V_{IN}}{\Delta V_{OUT}}$	Ripple Rejection	$f = 120\text{ Hz}$ $12\text{V} \leq V_{IN} \leq 22\text{V}$	39	45		dB
I_{PK}	Peak Output Current			140		mA
$\frac{\Delta V_O}{\Delta T}$	Average Output Voltage Tempco	$I_O = 5\text{mA}$		-0.8		$\text{mV}/^\circ\text{C}$
$V_{IN}(\text{Min})$	Minimum Value of Input Voltage Required to Maintain Line Regulation			9.9		V

LM78LXX Electrical Characteristics Limits in standard typeface are for $T_J = 25^\circ\text{C}$, **Bold typeface applies over 0°C to 125°C for SO-8 and TO-92 packages, and -40°C to 85°C for micro SMD package.** Limits are guaranteed by production testing or correlation techniques using standard Statistical Quality Control (SQC) methods. Unless otherwise specified: $I_O = 40\text{mA}$, $C_I = 0.33\mu\text{F}$, $C_O = 0.1\mu\text{F}$. (Continued)

LM78L09AC

Unless otherwise specified, $V_{IN} = 15\text{V}$

Symbol	Parameter	Conditions	Min	Typ	Max	Units
V_O	Output Voltage		8.64	9.0	9.36	V
		$11.5\text{V} \leq V_{IN} \leq 24\text{V}$ $1\text{mA} \leq I_O \leq 40\text{mA}$ (Note 3)	8.55		9.45	
		$1\text{mA} \leq I_O \leq 70\text{mA}$ (Note 3)	8.55		9.45	
ΔV_O	Line Regulation	$11.5\text{V} \leq V_{IN} \leq 24\text{V}$		100	200	mV
		$13\text{V} \leq V_{IN} \leq 24\text{V}$		90	150	
ΔV_O	Load Regulation	$1\text{mA} \leq I_O \leq 100\text{mA}$		20	90	mV
		$1\text{mA} \leq I_O \leq 40\text{mA}$		10	45	
I_Q	Quiescent Current			2	5.5	mA
ΔI_Q	Quiescent Current Change	$11.5\text{V} \leq V_{IN} \leq 24\text{V}$ $1\text{mA} \leq I_O \leq 40\text{mA}$			1.5 0.1	
V_n	Output Noise Voltage			70		μV
$\frac{\Delta V_{IN}}{\Delta V_{OUT}}$	Ripple Rejection	$f = 120\text{ Hz}$ $15\text{V} \leq V_{IN} \leq 25\text{V}$	38	44		dB
I_{PK}	Peak Output Current			140		mA
$\frac{\Delta V_O}{\Delta T}$	Average Output Voltage Tempco	$I_O = 5\text{mA}$		-0.9		$\text{mV}/^\circ\text{C}$
$V_{IN}(\text{Min})$	Minimum Value of Input Voltage Required to Maintain Line Regulation			10.7		V

LM78L12AC

Unless otherwise specified, $V_{IN} = 19\text{V}$

Symbol	Parameter	Conditions	Min	Typ	Max	Units
V_O	Output Voltage		11.5	12	12.5	V
		$14.5\text{V} \leq V_{IN} \leq 27\text{V}$ $1\text{mA} \leq I_O \leq 40\text{mA}$ (Note 3)	11.4		12.6	
		$1\text{mA} \leq I_O \leq 70\text{mA}$ (Note 3)	11.4		12.6	
ΔV_O	Line Regulation	$14.5\text{V} \leq V_{IN} \leq 27\text{V}$		30	180	mV
		$16\text{V} \leq V_{IN} \leq 27\text{V}$		20	110	
ΔV_O	Load Regulation	$1\text{mA} \leq I_O \leq 100\text{mA}$		30	100	mV
		$1\text{mA} \leq I_O \leq 40\text{mA}$		10	50	
I_Q	Quiescent Current			3	5	mA
ΔI_Q	Quiescent Current Change	$16\text{V} \leq V_{IN} \leq 27\text{V}$ $1\text{mA} \leq I_O \leq 40\text{mA}$			1 0.1	
V_n	Output Noise Voltage			80		μV
$\frac{\Delta V_{IN}}{\Delta V_{OUT}}$	Ripple Rejection	$f = 120\text{ Hz}$ $15\text{V} \leq V_{IN} \leq 25\text{V}$	40	54		dB
I_{PK}	Peak Output Current			140		mA
$\frac{\Delta V_O}{\Delta T}$	Average Output Voltage Tempco	$I_O = 5\text{mA}$		-1.0		$\text{mV}/^\circ\text{C}$

LM78LXX Electrical Characteristics Limits in standard typeface are for $T_J = 25^\circ\text{C}$, **Bold typeface applies over 0°C to 125°C for SO-8 and TO-92 packages, and -40°C to 85°C for micro SMD package.** Limits are guaranteed by production testing or correlation techniques using standard Statistical Quality Control (SQC) methods. Unless otherwise specified: $I_O = 40\text{mA}$, $C_I = 0.33\mu\text{F}$, $C_O = 0.1\mu\text{F}$. (Continued)

LM78L12AC (Continued)

Unless otherwise specified, $V_{IN} = 19\text{V}$

Symbol	Parameter	Conditions	Min	Typ	Max	Units
V_{IN} (Min)	Minimum Value of Input Voltage Required to Maintain Line Regulation			13.7	14.5	V

LM78L15AC

Unless otherwise specified, $V_{IN} = 23\text{V}$

Symbol	Parameter	Conditions	Min	Typ	Max	Units
V_O	Output Voltage			14.4	15.0	15.6
		$17.5\text{V} \leq V_{IN} \leq 30\text{V}$ $1\text{mA} \leq I_O \leq 40\text{mA}$ (Note 3)	14.25		15.75	V
		$1\text{mA} \leq I_O \leq 70\text{mA}$ (Note 3)	14.25		15.75	
ΔV_O	Line Regulation	$17.5\text{V} \leq V_{IN} \leq 30\text{V}$		37	250	mV
		$20\text{V} \leq V_{IN} \leq 30\text{V}$		25	140	
ΔV_O	Load Regulation	$1\text{mA} \leq I_O \leq 100\text{mA}$		35	150	mV
		$1\text{mA} \leq I_O \leq 40\text{mA}$		12	75	
I_Q	Quiescent Current			3	5	mA
ΔI_Q	Quiescent Current Change	$20\text{V} \leq V_{IN} \leq 30\text{V}$ $1\text{mA} \leq I_O \leq 40\text{mA}$			1 0.1	
V_n	Output Noise Voltage			90		μV
$\frac{\Delta V_{IN}}{\Delta V_{OUT}}$	Ripple Rejection	$f = 120\text{Hz}$ $18.5\text{V} \leq V_{IN} \leq 28.5\text{V}$	37	51		dB
I_{PK}	Peak Output Current			140		mA
$\frac{\Delta V_O}{\Delta T}$	Average Output Voltage Tempco	$I_O = 5\text{mA}$		-1.3		$\text{mV}/^\circ\text{C}$
V_{IN} (Min)	Minimum Value of Input Voltage Required to Maintain Line Regulation			16.7	17.5	V

Note 1: Absolute Maximum Ratings indicate limits beyond which damage to the device may occur. Electrical specifications do not apply when operating the device outside of its stated operating conditions.

Note 2: Human body model, 1.5 k Ω in series with 100pF.

Note 3: Power dissipation $\leq 0.75\text{W}$.

Note 4: Recommended minimum load capacitance of 0.01 μF to limit high frequency noise.

Note 5: Typical thermal resistance values for the packages are:

Z Package: $\theta_{JC} = 60^\circ\text{C}/\text{W}$, $\theta_{JA} = 230^\circ\text{C}/\text{W}$

M Package: $\theta_{JA} = 180^\circ\text{C}/\text{W}$

micro SMD Package: $\theta_{JA} = 230.9^\circ\text{C}/\text{W}$

Typical Performance Characteristics

Maximum Average Power Dissipation (Z Package)

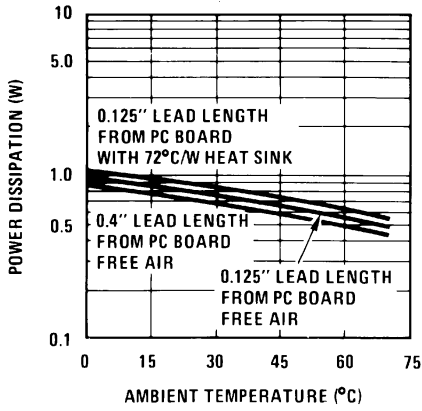

00774414

Peak Output Current

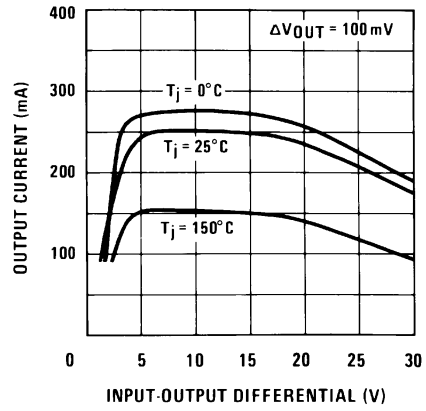

00774416

Dropout Voltage

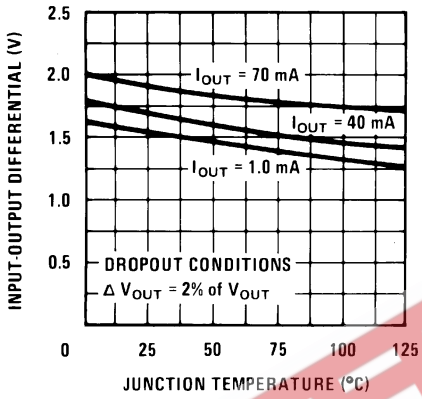

00774417

Ripple Rejection

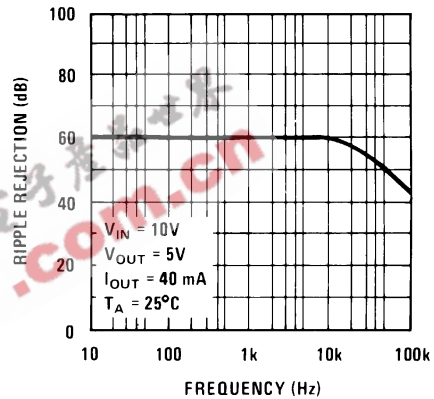

00774418

Output Impedance

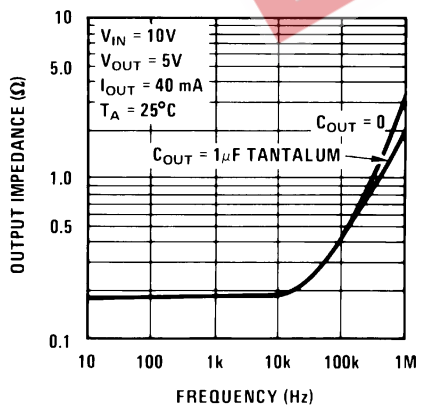

00774419

Quiescent Current

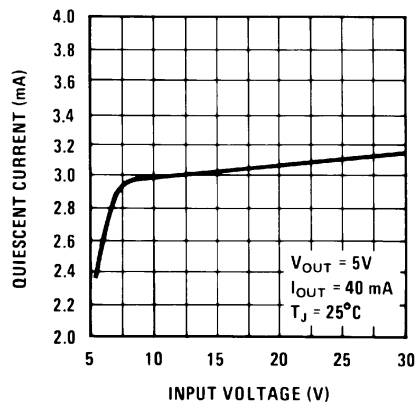

00774420

Typical Performance Characteristics (Continued)

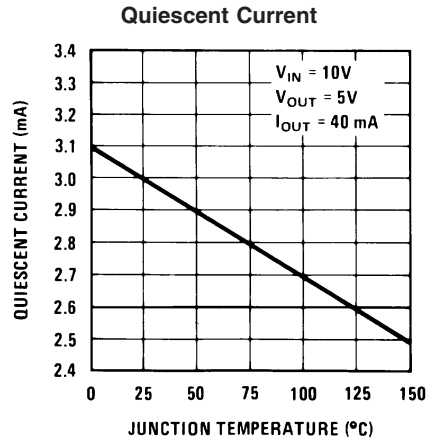

Equivalent Circuit

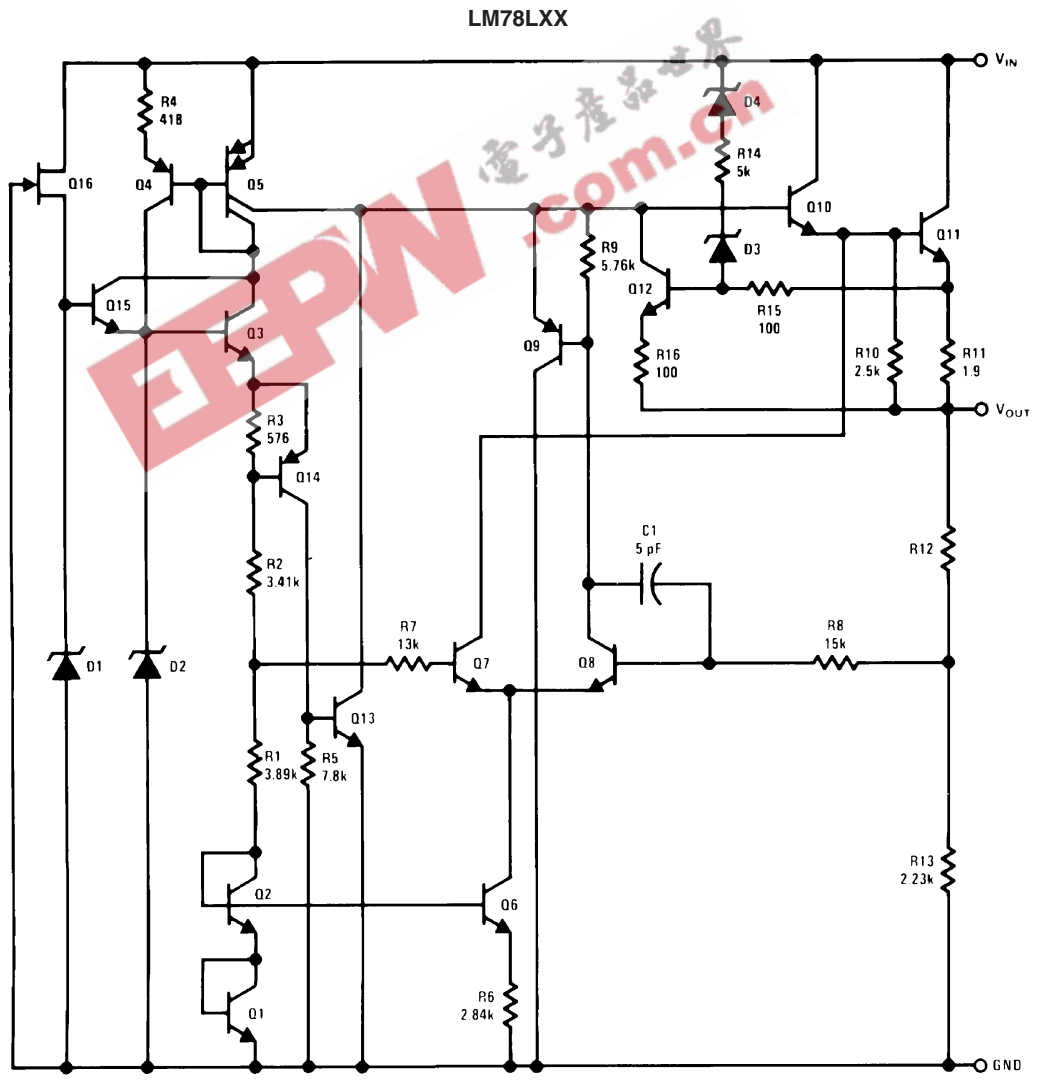

Typical Applications

Fixed Output Regulator

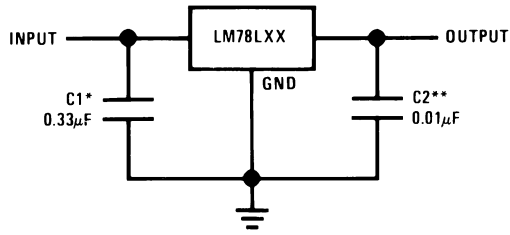

00774408

*Required if the regulator is located more than 3" from the power supply filter.

**See (Note 4) in the electrical characteristics table.

Adjustable Output Regulator

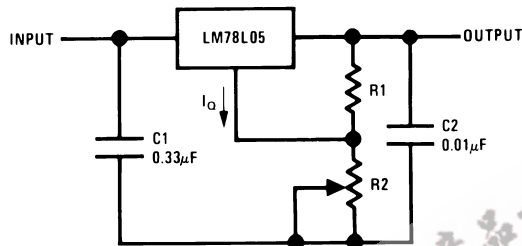

00774409

$$V_{OUT} = 5V + (5V/R1 + I_Q) R2$$

$$5V/R1 > 3 I_Q, \text{ load regulation } (L_r) \approx [(R1 + R2)/R1] (L_r \text{ of LM78L05})$$

Current Regulator

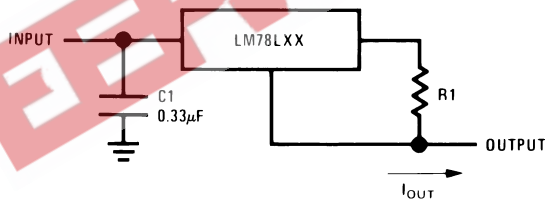

00774410

$$I_{OUT} = (V_{OUT}/R1) + I_Q$$

>I_Q = 1.5mA over line and load changes

5V, 500mA Regulator with Short Circuit Protection

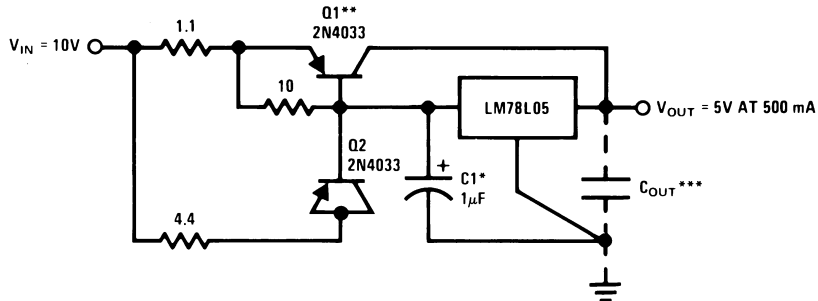

00774411

*Solid tantalum.

**Heat sink Q1.

***Optional: Improves ripple rejection and transient response.

Load Regulation: 0.6% $0 \leq I_L \leq 250\text{mA}$ pulsed with $t_{ON} = 50\text{ms}$.

Physical Dimensions inches (millimeters) unless otherwise noted

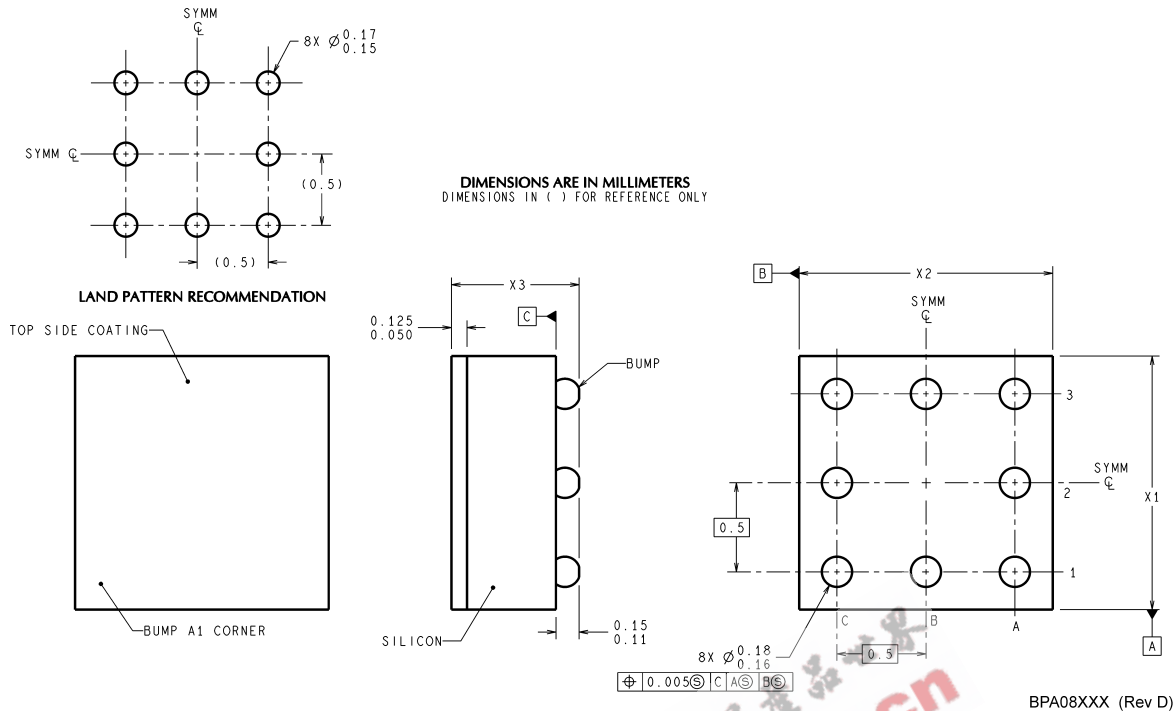

NOTES: UNLESS OTHERWISE SPECIFIED

1. EPOXY COATING
2. 63Sn/37Pb EUTECTIC BUMP
3. RECOMMEND NON-SOLDER MASK DEFINED LANDING PAD.
4. PIN A1 IS ESTABLISHED BY LOWER LEFT CORNER WITH RESPECT TO TEXT ORIENTATION. REMAINING PINS ARE NUMBERED COUNTERCLOCKWISE.
5. XXX IN DRAWING NUMBER REPRESENTS PACKAGE SIZE VARIATION WHERE X₁ IS PACKAGE WIDTH, X₂ IS PACKAGE LENGTH AND X₃ IS PACKAGE HEIGHT.
6. REFERENCE JEDEC REGISTRATION MO-211, VARIATION BC.

8-Bump micro SMD for LM78L05IBP Only
NS Package Number BPA08AAB
X1 = 1.285mm X2 = 1.285mm X3 = 0.850mm

Physical Dimensions inches (millimeters) unless otherwise noted (Continued)

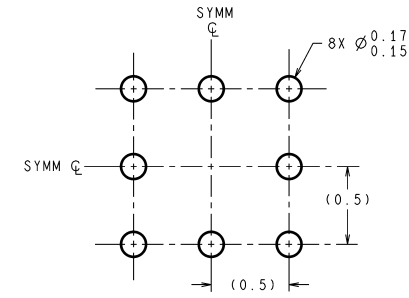

LAND PATTERN RECOMMENDATION

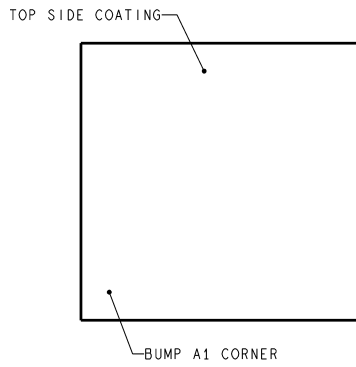

DIMENSIONS ARE IN MILLIMETERS
DIMENSIONS IN () FOR REFERENCE ONLY

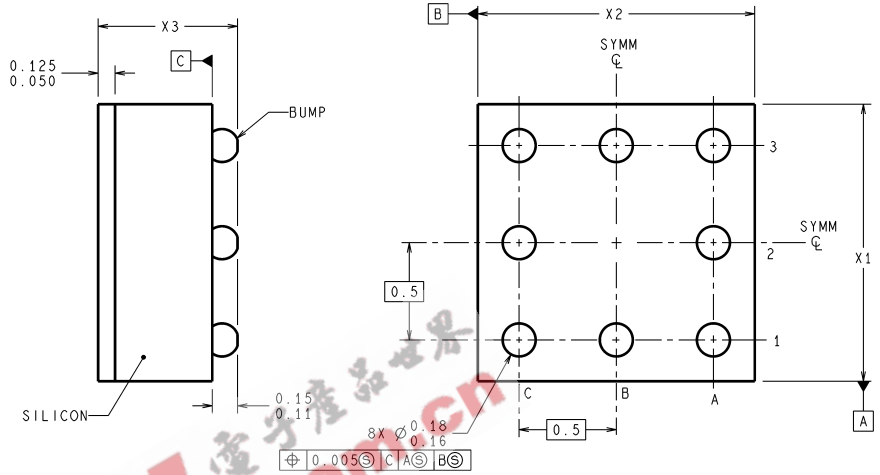

TPA08XXX (Rev B)

8-Bump micro SMD for LM78L09ITP Only
NS Package Number TPA08AAA
X1 = 1.285mm X2 = 1.285mm X3 = 0.500mm

Physical Dimensions inches (millimeters) unless otherwise noted (Continued)

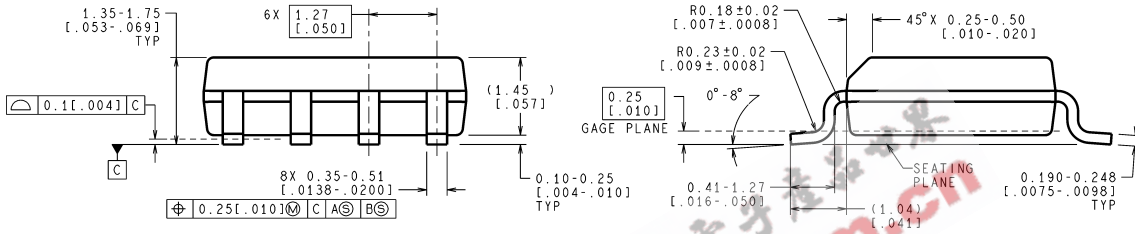
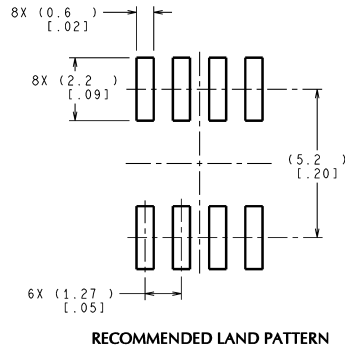
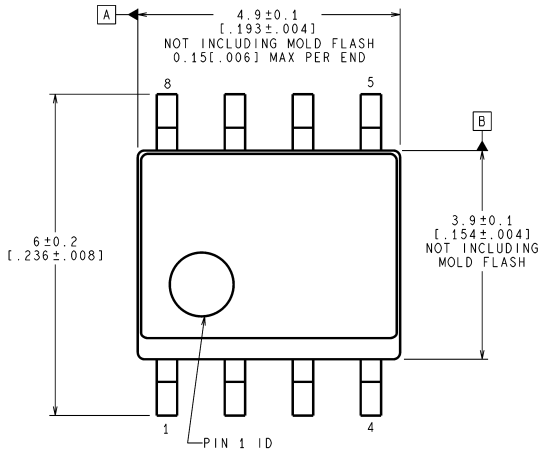

CONTROLLING DIMENSION IS MILLIMETER
VALUES IN [] ARE INCHES
DIMENSIONS IN () FOR REFERENCE ONLY

M08A (Rev K)

S.O. Package (M)
NS Package Number M08A

Physical Dimensions inches (millimeters) unless otherwise noted (Continued)

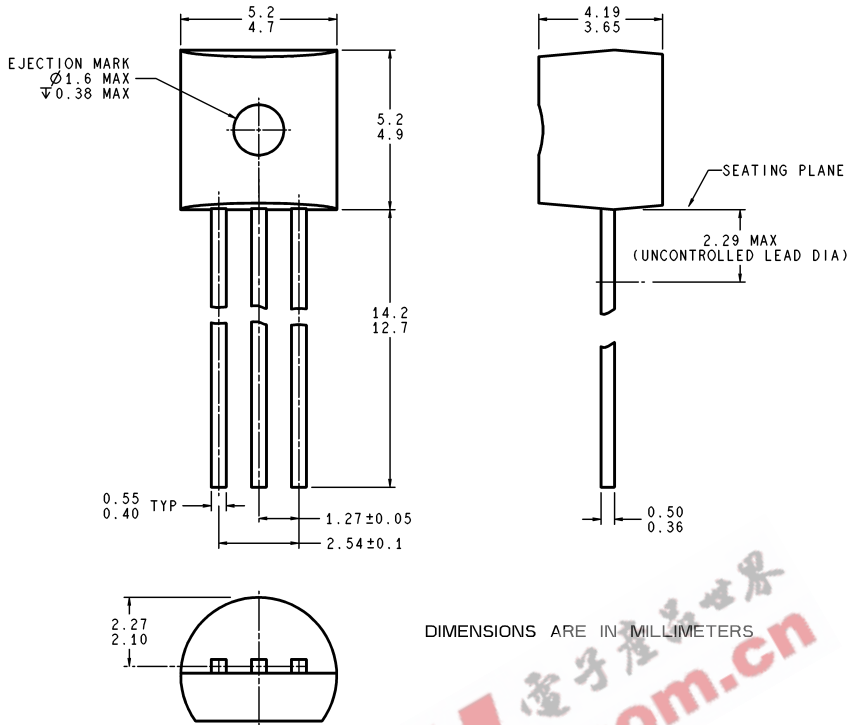

Molded Offset TO-92 (Z)
NS Package Number Z03A

Z03A (Rev G)

National does not assume any responsibility for use of any circuitry described, no circuit patent licenses are implied and National reserves the right at any time without notice to change said circuitry and specifications.

For the most current product information visit us at www.national.com.

LIFE SUPPORT POLICY

NATIONAL'S PRODUCTS ARE NOT AUTHORIZED FOR USE AS CRITICAL COMPONENTS IN LIFE SUPPORT DEVICES OR SYSTEMS WITHOUT THE EXPRESS WRITTEN APPROVAL OF THE PRESIDENT AND GENERAL COUNSEL OF NATIONAL SEMICONDUCTOR CORPORATION. As used herein:

1. Life support devices or systems are devices or systems which, (a) are intended for surgical implant into the body, or (b) support or sustain life, and whose failure to perform when properly used in accordance with instructions for use provided in the labeling, can be reasonably expected to result in a significant injury to the user.
2. A critical component is any component of a life support device or system whose failure to perform can be reasonably expected to cause the failure of the life support device or system, or to affect its safety or effectiveness.

BANNED SUBSTANCE COMPLIANCE

National Semiconductor manufactures products and uses packing materials that meet the provisions of the Customer Products Stewardship Specification (CSP-9-111C2) and the Banned Substances and Materials of Interest Specification (CSP-9-111S2) and contain no "Banned Substances" as defined in CSP-9-111S2.



National Semiconductor
Americas Customer
Support Center
Email: new.feedback@nsc.com
Tel: 1-800-272-9959

National Semiconductor
Europe Customer Support Center
Fax: +49 (0) 180-530 85 86
Email: europe.support@nsc.com
Deutsch Tel: +49 (0) 69 9508 6208
English Tel: +44 (0) 870 24 0 2171
Français Tel: +33 (0) 1 41 91 8790

National Semiconductor
Asia Pacific Customer
Support Center
Email: ap.support@nsc.com

National Semiconductor
Japan Customer Support Center
Fax: 81-3-5639-7507
Email: jpn.feedback@nsc.com
Tel: 81-3-5639-7560