



LM7800 Series 3-Terminal Positive Voltage Regulators

General Description

The LM7800 series of monolithic 3-terminal positive voltage regulators employ internal current-limiting, thermal shut-down and safe-area compensation, making them essentially indestructible. If adequate heat sinking is provided, they can deliver over 1.0A output current. They are intended as fixed voltage regulators in a wide range of applications including local (on-card) regulation for elimination of noise and distribution problems associated with single-point regulation. In addition to use as fixed voltage regulators, these devices can be used with external components to obtain adjustable output voltages and currents.

Features

- Output current in excess of 1.0A
- No external components
- Internal thermal overload protection
- Internal short circuit current-limiting
- Output transistor safe-area compensation
- Available in JEDEC TO-220 and TO-3 packages
- Output voltages of 6V, 8V, 18V and 24V (See Note)
- Available in extended temperature range

Connection Diagrams

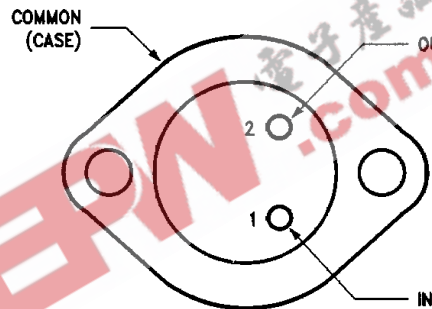

Top View

TL/H/10052-1

Order Number LM7806K, LM7808K, LM7818K,
LM7824K, LM7806CK, LM7808CK,
LM7818CK or LM7824CK
See NS Package Number K02A

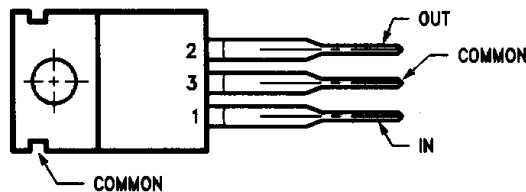

Lead 3 connected to tab.

Top View

TL/H/10052-2

Order Number LM7806CT, LM7808CT
LM7818CT or LM7824CT
See NS Package Number T03B

Note: See General Purpose Linear Databook for specifications on similar devices with 5V, 12V, or 15V outputs. These parts can be found under LM140/LM340, LM140A/LM340A (for tighter output tolerance) and LM78XX datasheets.

Absolute Maximum Ratings

If Military/Aerospace specified devices are required, please contact the National Semiconductor Sales Office/Distributors for availability and specifications.

Storage Temperature Range

TO-3 Metal Can	-65°C to +175°C
TO-220 Package	-65°C to +150°C

Operating Junction Temperature Range

Extended (LM7800)	-55°C to +150°C
Commercial (LM7800C)	0°C to +150°C

Lead Temperature

TO-3 Metal Can (Soldering, 60 sec.)	300°C
TO-220 Package (Soldering, 10 sec.)	265°C

Power Dissipation

Internally Limited

Input Voltage

6.0V to 18V	35V
24V	40V

ESD Susceptibility

(to be determined)

LM7806C

Electrical Characteristics

0°C ≤ T_A ≤ +125°C, V_I = 11V, I_O = 500 mA, C_I = 0.33 μF, C_O = 0.1 μF, unless otherwise specified

Symbol	Parameter	Conditions (Note 1)	Min	Typ	Max	Units
V _O	Output Voltage	T _J = 25°C	5.75	6.0	6.25	V
V _{R LINE}	Line Regulation	T _J = 25°C		5.0	120	mV
		8.0V ≤ V _I ≤ 25V		1.5	60	
V _{R LOAD}	Load Regulation	T _J = 25°C		14	120	mV
		5.0 mA ≤ I _O ≤ 1.5A		4.0	60	
V _O	Output Voltage	8.0V ≤ V _I ≤ 21V, 5.0 mA ≤ I _O ≤ 1.0A, P ≤ 15W	5.7		6.3	V
I _Q	Quiescent Current	T _J = 25°C		4.3	8.0	mA
ΔI _Q	Quiescent Current Change	With Line	8.0V ≤ V _I ≤ 25V		1.3	mA
		With Load	5.0 mA ≤ I _O ≤ 1.0A		0.5	
N _O	Noise	T _A = 25°C, 10 Hz ≤ f ≤ 100 kHz		45		μV
ΔV _I /ΔV _O	Ripple Rejection	f = 2400 Hz, I _O = 350 mA, T _J = 25°C	59	75		dB
V _{DD}	Dropout Voltage	I _O = 1.0A, T _J = 25°C		2.0		V
R _O	Output Resistance	f = 1.0 kHz		19		mΩ
I _{OS}	Output Short Circuit Current	T _J = 25°C, V _I = 35V		550		mA
I _{pk}	Peak Output Current	T _J = 25°C		2.2		A
ΔV _O /ΔT	Average Temperature Coefficient of Output Voltage	I _O = 5.0 mA, 0°C ≤ T _A ≤ +125°C		0.8		mV/°C

LM7808

Electrical Characteristics

-55°C ≤ T_A ≤ +125°C, V_I = 14V, I_O = 500 mA, C_I = 0.33 μF, C_O = 0.1 μF, unless otherwise specified

Symbol	Parameter	Conditions (Note 1)	Min	Typ	Max	Units
V _O	Output Voltage	T _J = 25°C	7.7	8.0	8.3	V
V _{R LINE}	Line Regulation	T _J = 25°C		6.0	80	mV
		10.5V ≤ V _I ≤ 25V		2.0	40	
V _{R LOAD}	Load Regulation	T _J = 25°C		12	100	mV
		5.0 mA ≤ I _O ≤ 1.5A		4.0	40	
V _O	Output Voltage	11.5V ≤ V _I ≤ 23V, 5.0 mA ≤ I _O ≤ 1.0A, P ≤ 15W	7.6		8.4	V
I _Q	Quiescent Current	T _J = 25°C		4.3	6.0	mA
ΔI _Q	Quiescent Current Change	With Line	11.5V ≤ V _I ≤ 25V		0.8	mA
		With Load	5.0 mA ≤ I _O ≤ 1.0A		0.5	

LM7808**Electrical Characteristics** (Continued)
 $-55^{\circ}\text{C} \leq T_A \leq +125^{\circ}\text{C}$, $V_I = 14\text{V}$, $I_O = 500\text{ mA}$, $C_I = 0.33\ \mu\text{F}$, $C_O = 0.1\ \mu\text{F}$, unless otherwise specified

Symbol	Parameter	Conditions (Note 1)	Min	Typ	Max	Units
N_O	Noise	$T_A = 25^{\circ}\text{C}$, $10\text{ Hz} \leq f \leq 100\text{ kHz}$		8.0	40	$\mu\text{V}/V_O$
$\Delta V_I/\Delta V_O$	Ripple Rejection	$f = 2400\text{ Hz}$, $I_O = 350\text{ mA}$, $T_J = 25^{\circ}\text{C}$	62	72		dB
V_{DO}	Dropout Voltage	$I_O = 1.0\text{A}$, $T_J = 25^{\circ}\text{C}$		2.0	2.5	V
R_O	Output Resistance	$f = 1.0\text{ kHz}$		16		$\text{m}\Omega$
I_{OS}	Output Short Circuit Current	$T_J = 25^{\circ}\text{C}$, $V_I = 35\text{V}$		0.75	1.2	A
I_{pk}	Peak Output Current	$T_J = 25^{\circ}\text{C}$	1.3	2.2	3.3	A
$\Delta V_O/\Delta T$	Average Temperature Coefficient of Output Voltage	$I_O = 5.0\text{ mA}$			0.4	$\text{mV}/^{\circ}\text{C}/V_O$
			$-55^{\circ}\text{C} \leq T_A \leq +25^{\circ}\text{C}$		0.3	

LM7808C**Electrical Characteristics**
 $0^{\circ}\text{C} \leq T_A \leq +125^{\circ}\text{C}$, $V_I = 14\text{V}$, $I_O = 500\text{ mA}$, $C_I = 0.33\ \mu\text{F}$, $C_O = 0.1\ \mu\text{F}$, unless otherwise specified

Symbol	Parameter	Conditions (Note 1)	Min	Typ	Max	Units	
V_O	Output Voltage	$T_J = 25^{\circ}\text{C}$	7.7	8.0	8.3	V	
$V_{R\text{ LINE}}$	Line Regulation	$T_J = 25^{\circ}\text{C}$	$10.5\text{V} \leq V_I \leq 25\text{V}$		6.0	160	mV
			$11\text{V} \leq V_I \leq 17\text{V}$		2.0	80	
$V_{R\text{ LOAD}}$	Load Regulation	$T_J = 25^{\circ}\text{C}$	$5.0\text{ mA} \leq I_O \leq 1.5\text{A}$		12	160	mV
			$250\text{ mA} \leq I_O \leq 750\text{ mA}$		4.0	80	
V_O	Output Voltage	$10.5\text{V} \leq V_I \leq 23\text{V}$, $5.0\text{ mA} \leq I_O \leq 1.0\text{A}$, $P \leq 15\text{W}$	7.6		8.4	V	
I_Q	Quiescent Current	$T_J = 25^{\circ}\text{C}$		4.3	8.0	mA	
ΔI_Q	Quiescent Current Change	With Line	$10.5\text{V} \leq V_I \leq 25\text{V}$			1.0	mA
		With Load	$5.0\text{ mA} \leq I_O \leq 1.0\text{A}$			0.5	
N_O	Noise	$T_A = 25^{\circ}\text{C}$, $10\text{ Hz} \leq f \leq 100\text{ kHz}$		52		μV	
$\Delta V_I/\Delta V_O$	Ripple Rejection	$f = 2400\text{ Hz}$, $I_O = 350\text{ mA}$, $T_J = 25^{\circ}\text{C}$	56	72		dB	
V_{DO}	Dropout Voltage	$I_O = 1.0\text{A}$, $T_J = 25^{\circ}\text{C}$		2.0		V	
R_O	Output Resistance	$f = 1.0\text{ kHz}$		16		$\text{m}\Omega$	
I_{OS}	Output Short Circuit Current	$T_J = 25^{\circ}\text{C}$, $V_I = 35\text{V}$		450		mA	
I_{pk}	Peak Output Current	$T_J = 25^{\circ}\text{C}$		2.2		A	
$\Delta V_O/\Delta T$	Average Temperature Coefficient of Output Voltage	$I_O = 5.0\text{ mA}$		0.8		$\text{mV}/^{\circ}\text{C}$	

LM7818**Electrical Characteristics**
 $-55^{\circ}\text{C} \leq T_A \leq +125^{\circ}\text{C}$, $V_I = 27\text{V}$, $I_O = 500\text{ mA}$, $C_I = 0.33\ \mu\text{F}$, $C_O = 0.1\ \mu\text{F}$, unless otherwise specified

Symbol	Parameter	Conditions (Note 1)	Min	Typ	Max	Units
V_O	Output Voltage	$T_J = 25^{\circ}\text{C}$	17.3	18.0	18.7	V
$V_{R\text{ LINE}}$	Line Regulation	$T_J = 25^{\circ}\text{C}$	$21\text{V} \leq V_I \leq 33\text{V}$	15	180	mV
			$24\text{V} \leq V_I \leq 30\text{V}$	5.0	90	
$V_{R\text{ LOAD}}$	Load Regulation	$T_J = 25^{\circ}\text{C}$	$5.0\text{ mA} \leq I_O \leq 1.5\text{A}$	12	180	mV
			$250\text{ mA} \leq I_O \leq 750\text{ mA}$	4.0	90	
V_O	Output Voltage	$22\text{V} \leq V_I \leq 33\text{V}$, $5.0\text{ mA} \leq I_O \leq 1.0\text{A}$, $P \leq 15\text{W}$	17.1		18.9	V
I_Q	Quiescent Current	$T_J = 25^{\circ}\text{C}$		4.5	6.0	mA
ΔI_Q	Quiescent Current Change	With Line	$22\text{V} \leq V_I \leq 33\text{V}$		0.8	mA
		With Load	$5.0\text{ mA} \leq I_O \leq 1.0\text{A}$		0.5	
N_O	Noise	$T_A = 25^{\circ}\text{C}$, $10\text{ Hz} \leq f \leq 100\text{ kHz}$		8.0	40	$\mu\text{V}/V_O$
$\Delta V_I/\Delta V_O$	Ripple Rejection	$f = 2400\text{ Hz}$, $I_O = 350\text{ mA}$, $T_J = 25^{\circ}\text{C}$	59	69		dB
V_{DO}	Dropout Voltage	$I_O = 1.0\text{A}$, $T_J = 25^{\circ}\text{C}$		2.0		V
R_O	Output Resistance	$f = 1.0\text{ kHz}$		22		$\text{m}\Omega$
I_{OS}	Output Short Circuit Current	$T_J = 25^{\circ}\text{C}$, $V_I = 35\text{V}$		0.75		A
I_{pk}	Peak Output Current	$T_J = 25^{\circ}\text{C}$	1.3	2.2	3.3	A
$\Delta V_O/\Delta T$	Average Temperature Coefficient of Output Voltage	$I_O = 5.0\text{ mA}$	$-55^{\circ}\text{C} \leq T_A \leq +25^{\circ}\text{C}$		0.4	$\text{mV}/^{\circ}\text{C}/V_O$
			$+25^{\circ}\text{C} \leq T_A \leq +125^{\circ}\text{C}$		0.3	

LM7818C**Electrical Characteristics**
 $0^{\circ}\text{C} \leq T_A \leq +125^{\circ}\text{C}$, $V_I = 27\text{V}$, $I_O = 500\text{ mA}$, $C_I = 0.33\ \mu\text{F}$, $C_O = 0.1\ \mu\text{F}$, unless otherwise specified.

Symbol	Parameter	Conditions (Note 1)	Min	Typ	Max	Units
V_O	Output Voltage	$T_J = 25^{\circ}\text{C}$	17.3	18.0	18.7	V
$V_{R\text{ LINE}}$	Line Regulation	$T_J = 25^{\circ}\text{C}$	$21\text{V} \leq V_I \leq 33\text{V}$	15	360	mV
			$24\text{V} \leq V_I \leq 30\text{V}$	5.0	180	
$V_{R\text{ LOAD}}$	Load Regulation	$T_J = 25^{\circ}\text{C}$	$5.0\text{ mA} \leq I_O \leq 1.5\text{A}$	12	360	mV
			$250\text{ mA} \leq I_O \leq 750\text{ mA}$	4.0	180	
V_O	Output Voltage	$21\text{V} \leq V_I \leq 33\text{V}$, $5.0\text{ mA} \leq I_O \leq 1.0\text{A}$, $P \leq 15\text{W}$	17.1		18.9	V
I_Q	Quiescent Current	$T_J = 25^{\circ}\text{C}$		4.5	8.0	mA

LM7818C**Electrical Characteristics** (Continued)
 $0^{\circ}\text{C} \leq T_A \leq +125^{\circ}\text{C}$, $V_I = 27\text{V}$, $I_O = 500\text{ mA}$, $C_I = 0.33\ \mu\text{F}$, $C_O = 0.1\ \mu\text{F}$, unless otherwise specified

Symbol	Parameter	Conditions (Note 1)	Min	Typ	Max	Units
ΔI_Q	Quiescent Current Change	With Line	$21\text{V} \leq V_I \leq 33\text{V}$		1.0	mA
		With Load	$5.0\text{ mA} \leq I_O \leq 1.0\text{A}$		0.5	
N_O	Noise	$T_A = 25^{\circ}\text{C}$, $10\text{ Hz} \leq f \leq 100\text{ kHz}$		110		μV
$\Delta V_I / \Delta V_O$	Ripple Rejection	$f = 2400\text{ Hz}$, $I_O = 350\text{ mA}$, $T_J = 25^{\circ}\text{C}$	53	69		dB
V_{DO}	Dropout Voltage	$I_O = 1.0\text{A}$, $T_J = 25^{\circ}\text{C}$		2.0		V
R_O	Output Resistance	$f = 1.0\text{ kHz}$		22		$\text{m}\Omega$
I_{OS}	Output Short Circuit Current	$T_J = 25^{\circ}\text{C}$, $V_I = 35\text{V}$		200		mA
I_{pk}	Peak Output Current	$T_J = 25^{\circ}\text{C}$		2.1		A
$\Delta V_O / \Delta T$	Average Temperature Coefficient of Output Voltage	$I_O = 5.0\text{ mA}$		1.0		$\text{mV}/^{\circ}\text{C}$

LM7824**Electrical Characteristics**
 $-55^{\circ}\text{C} \leq T_A \leq +125^{\circ}\text{C}$, $V_I = 33\text{V}$, $I_O = 500\text{ mA}$, $C_I = 0.33\ \mu\text{F}$, $C_O = 0.1\ \mu\text{F}$, unless otherwise specified

Symbol	Parameter	Conditions (Note 1)	Min	Typ	Max	Units
V_O	Output Voltage	$T_J = 25^{\circ}\text{C}$	23.0	24.0	25.0	V
$V_{R\text{ LINE}}$	Line Regulation	$T_J = 25^{\circ}\text{C}$	$27\text{V} \leq V_I \leq 38\text{V}$	18	240	mV
			$30\text{V} \leq V_I \leq 36\text{V}$	6.0	120	
$V_{R\text{ LOAD}}$	Load Regulation	$T_J = 25^{\circ}\text{C}$	$5.0\text{ mA} \leq I_O \leq 1.5\text{A}$	12	240	mV
			$250\text{ mA} \leq I_O \leq 750\text{ mA}$	4.0	120	
V_O	Output Voltage	$28\text{V} \leq V_I \leq 38\text{V}$, $5.0\text{ mA} \leq I_O \leq 1.0\text{A}$, $P \leq 15\text{W}$	22.8		25.2	V
I_Q	Quiescent Current	$T_J = 25^{\circ}\text{C}$		4.6	6.0	mA
ΔI_Q	Quiescent Current Change	With Line	$28\text{V} \leq V_I \leq 38\text{V}$		0.8	mA
		With Load	$5.0\text{ mA} \leq I_O \leq 1.0\text{A}$		0.5	
N_O	Noise	$T_A = 25^{\circ}\text{C}$, $10\text{ Hz} \leq f \leq 100\text{ kHz}$		8.0	40	$\mu\text{V}/V_O$
$\Delta V_I / \Delta V_O$	Ripple Rejection	$f = 2400\text{ Hz}$, $I_O = 350\text{ mA}$, $T_J = 25^{\circ}\text{C}$	56	66		dB
V_{DO}	Dropout Voltage	$I_O = 1.0\text{A}$, $T_J = 25^{\circ}\text{C}$		2.0	2.5	V
R_O	Output Resistance	$f = 1.0\text{ kHz}$		28		$\text{m}\Omega$
I_{OS}	Output Short Circuit Current	$T_J = 25^{\circ}\text{C}$, $V_I = 35\text{V}$		0.75	1.2	A
I_{pk}	Peak Output Current	$T_J = 25^{\circ}\text{C}$	1.3	2.2	3.3	A
$\Delta V_O / \Delta T$	Average Temperature Coefficient of Output Voltage	$I_O = 5.0\text{ mA}$	$-55^{\circ}\text{C} \leq T_A \leq +25^{\circ}\text{C}$		0.4	$\text{mV}/^{\circ}\text{C}/V_O$
			$+25^{\circ}\text{C} \leq T_A \leq +125^{\circ}\text{C}$		0.3	

LM7824C**Electrical Characteristics**
 $0^{\circ}\text{C} \leq T_A \leq +125^{\circ}\text{C}$, $V_I = 33\text{V}$, $I_O = 500\text{ mA}$, $C_I = 0.33\ \mu\text{F}$, $C_O = 0.1\ \mu\text{F}$, unless otherwise specified

Symbol	Characteristics	Conditions (Note 1)	Min	Typ	Max	Units
V_O	Output Voltage	$T_J = 25^{\circ}\text{C}$	23.0	24.0	25.0	V
$V_{R\text{ LINE}}$	Line Regulation	$T_J = 25^{\circ}\text{C}$	$27\text{V} \leq V_I \leq 38\text{V}$	18	480	mV
			$30\text{V} \leq V_I \leq 36\text{V}$	6.0	240	
$V_{R\text{ LOAD}}$	Load Regulation	$T_J = 25^{\circ}\text{C}$	$5.0\text{ mA} \leq I_O \leq 1.5\text{A}$	12	480	mV
			$250\text{ mA} \leq I_O \leq 750\text{ mA}$	4.0	240	
V_O	Output Voltage	$27\text{V} \leq V_I \leq 38\text{V}$, $5.0\text{ mA} \leq I_O \leq 1.0\text{A}$, $P \leq 15\text{W}$	22.8		25.2	V
I_Q	Quiescent Current	$T_J = 25^{\circ}\text{C}$		4.6	8.0	mA

Typical Performance Characteristics

Worst Case Power Dissipation vs Ambient Temperature (TO-3)

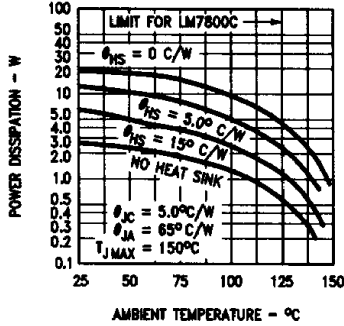

Worst Case Power Dissipation vs Ambient Temperature (TO-220)

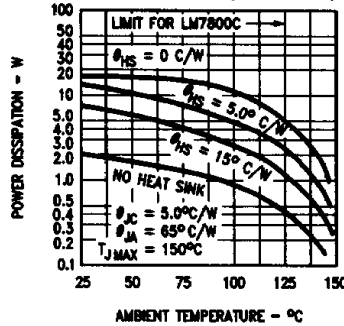

Peak Output Current vs Input/Output Voltage Differential

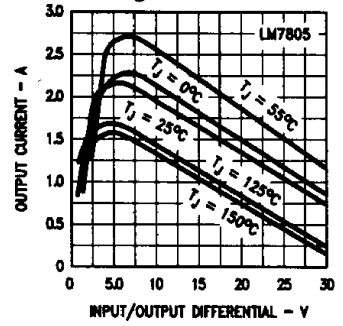

Output Voltage vs Junction Temperature

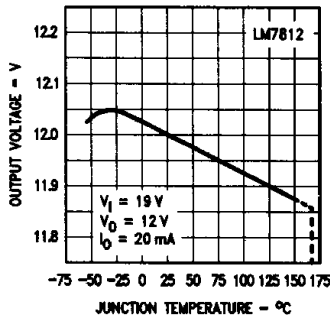

Current-Limiting Characteristics

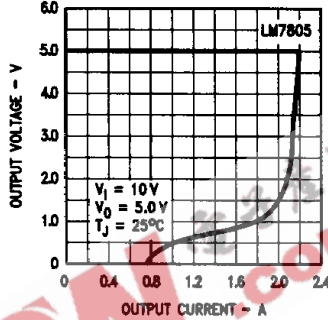

Dropout Voltage vs Junction Temperature

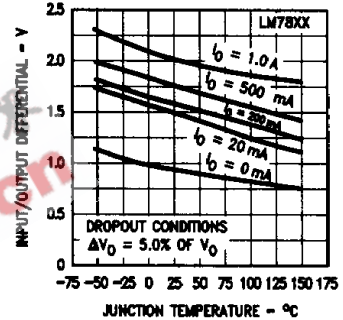

Dropout Characteristics

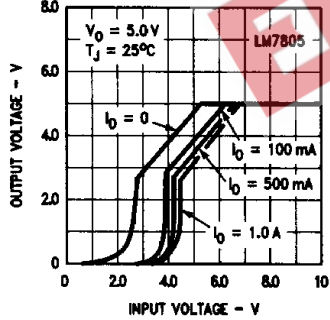

Quiescent Current vs Input Voltage

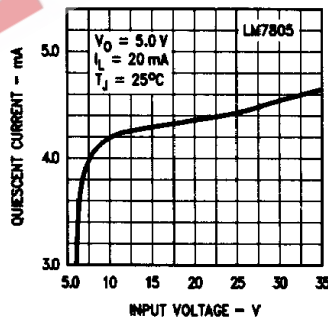

Quiescent Current vs Junction Temperature

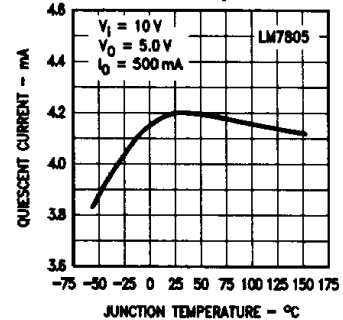

Ripple Rejection vs Frequency

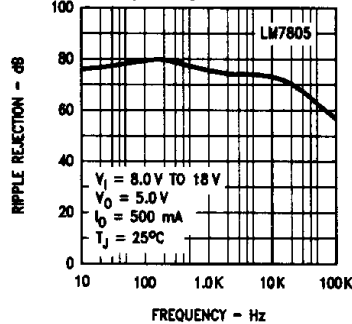

Line Transient Response

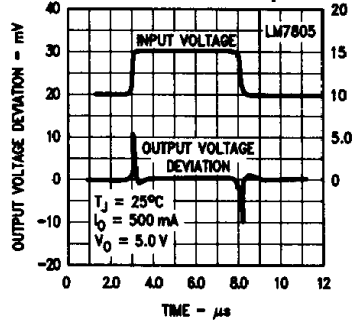

Load Transient Response

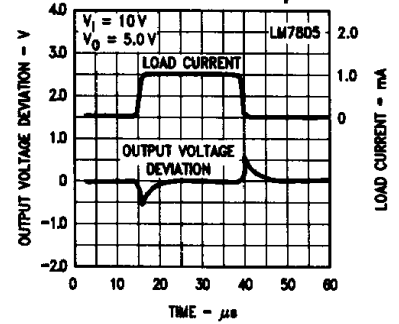

Typical Performance Characteristics (Continued)

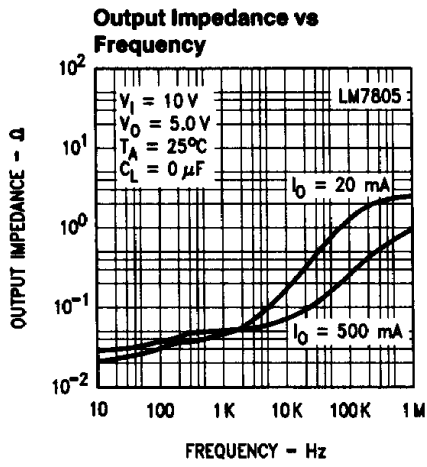

TL/H/10052-5

Note: The other LM7800 series devices have similar curves.

DC Parameter Test Circuit

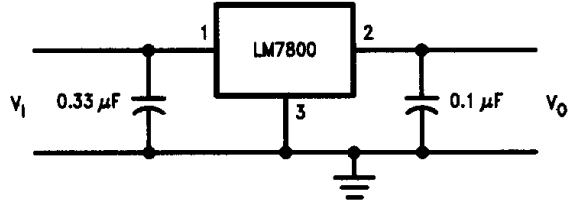

TL/H/10052-6

EEPW 电子产品世界 .com.cn

Design Considerations

The LM7800 fixed voltage regulator series has thermal overload protection from excessive power dissipation, internal short circuit protection which limits the regulator's maximum current, and output transistor safe-area compensation for reducing the output current as the voltage across the pass transistor is increased.

Although the internal power dissipation is limited, the junction temperature must be kept below the maximum specified temperature (150°C for LM7800, 125°C for LM7800C) in order to meet data sheet specifications. To calculate the maximum junction temperature or heat sink required, the following thermal resistance values should be used:

Package	Typ θ_{JC} °C/W	Max θ_{JC} °C/W	Typ θ_{JA} °C/W	Max θ_{JA} °C/W
TO-3	3.5	5.5	35	40
TO-220	3.0	5.0	40	60

$$P_{D \text{ Max}} = \frac{T_{J \text{ Max}} - T_A}{\theta_{JC} + \theta_{CA}} \text{ or}$$

$$= \frac{T_{J \text{ Max}} T_A}{\theta_{JA}} \text{ (without heat sink)}$$

$$\theta_{CA} = \theta_{CS} + \theta_{SA}$$

Solving for T_J :

$$T_J = T_A + P_D (\theta_{JC} + \theta_{CA}) \text{ or}$$

$$= T_A + P_D \theta_{JA} \text{ (without heat sink)}$$

Where:

T_J = Junction Temperature

T_A = Ambient Temperature

P_D = Power Dissipation

θ_{JC} = Junction-to-Case Thermal Resistance

θ_{CA} = Case-to-Ambient Thermal Resistance

θ_{CS} = Case-to-Heat Sink Thermal Resistance

θ_{SA} = Heat Sink-to-Ambient Thermal Resistance

θ_{JA} = Junction-to-Ambient Thermal Resistance

Typical Applications

Fixed Output Regulator

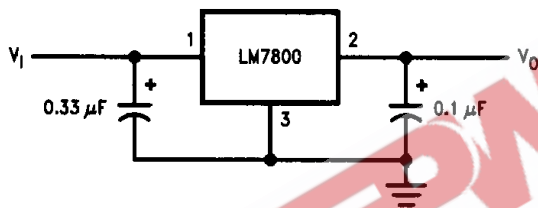

TL/H/10052-7

Note 1: To specify an output voltage, substitute voltage value for "00".

Note 2: Bypass capacitors are recommended for optimum stability and transient response, and should be located as close as possible to the regulator.

High Input Voltage Circuits

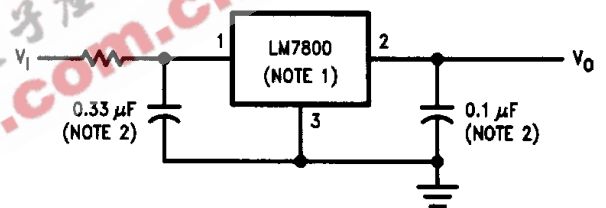

TL/H/10052-8

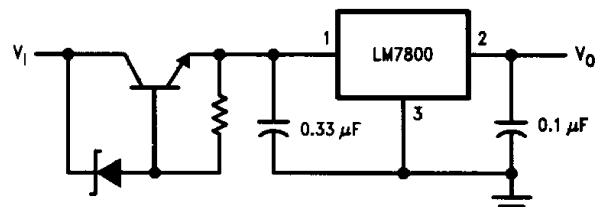

TL/H/10052-9

High Current Voltage Regulator

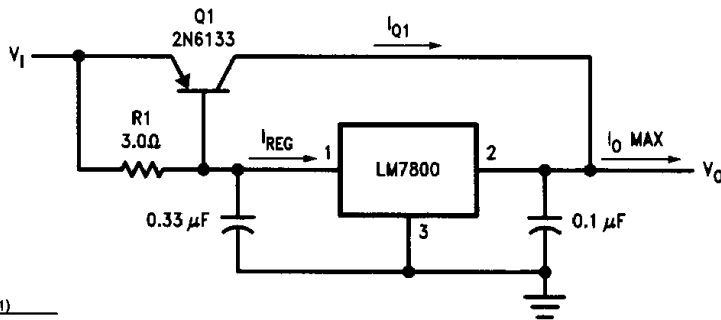

$$\beta(Q1) \geq \frac{I_{O \text{ Max}}}{I_{\text{REG Max}}}$$

$$R1 = \frac{0.9}{I_{\text{REG}}} = \frac{\beta(Q1) V_{BE}(Q1)}{I_{\text{REG Max}} (\beta + 1) - I_{O \text{ Max}}}$$

TL/H/10052-10

Typical Applications (Continued)

High Output Current, Short Circuit Protected

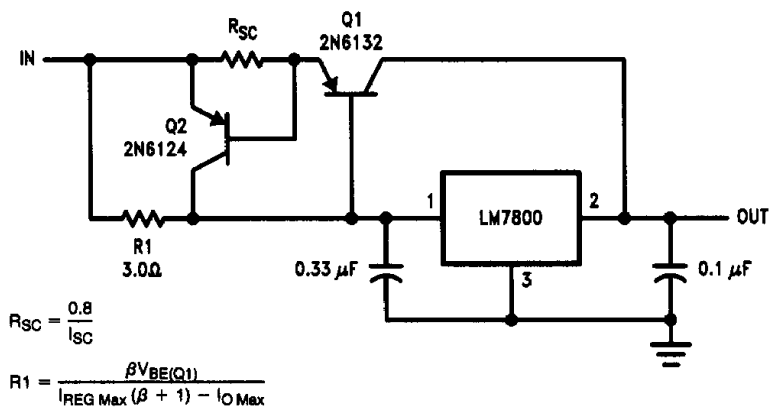

Positive and Negative Regulator

