

# LM78XX (KA78XX, MC78XX) FIXED VOLTAGE REGULATOR (POSITIVE)

## 3-TERMINAL 1A POSITIVE VOLTAGE REGULATORS

The LM78XX series of three-terminal positive regulators are available in the TO-220/D-PAK package and with several fixed output voltages, making them useful in a wide range of applications. Each type employs internal current limiting, thermal shut-down and safe area protection, making it essentially indestructible. If adequate heat sinking is provided, they can deliver over 1A output current. Although designed primarily as fixed voltage regulators, these devices can be used with external components to obtain adjustable voltages and currents.

## FEATURES

- Output Current up to 1A
- Output Voltages of 5, 6, 8, 9, 10, 11, 12, 15, 18, 24V
- Thermal Overload Protection
- Short Circuit Protection
- Output Transistor SOA Protection

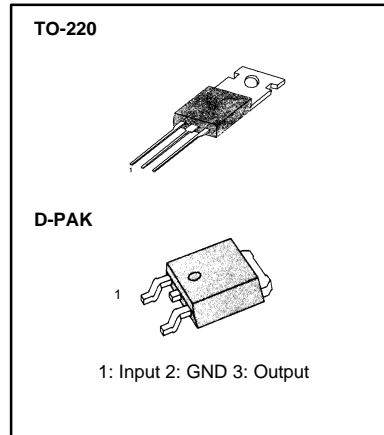

## ORDERING INFORMATION

Device	Output Voltage Tolerance	Packag	Operating Temperature
KA78XXCT	± 4%	TO-220	0 ~ +125 °C
KA78XXAT	± 2%		-40 ~ +125 °C
KA78XXIT	± 4%	D-PAK	0 ~ +125 °C
KA78XXR			-40 ~ +125 °C
KA78XXAR	± 2%	D-PAK	0 ~ +125 °C
KA78XXIR	± 4%		-40 ~ +125 °C

## BLOCK DIAGRAM

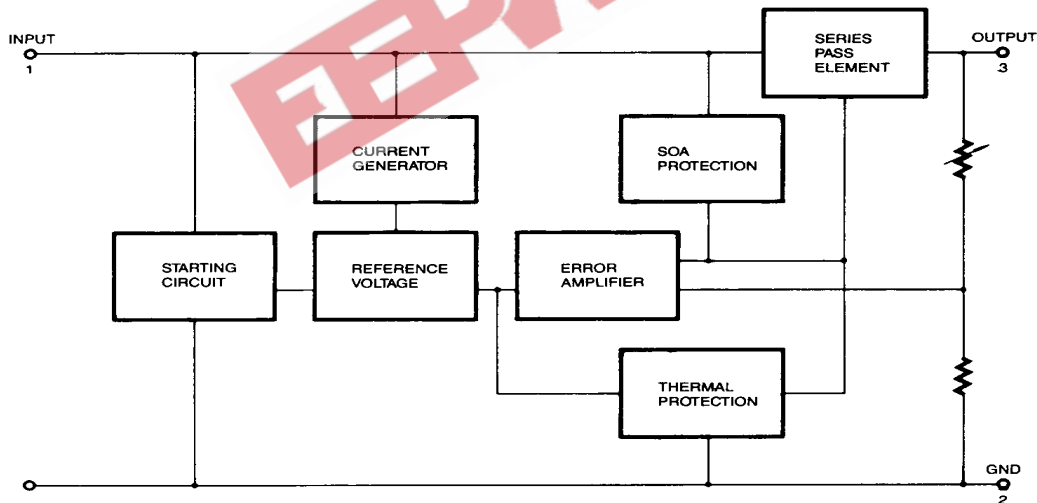

## LM78XX (KA78XX, MC78XX) FIXED VOLTAGE REGULATOR (POSITIVE)

### ABSOLUTE MAXIMUM RATINGS (T<sub>A</sub> = +25°C, unless otherwise specified)

Characteristic	Symbol	Value	Unit
Input Voltage (for V <sub>O</sub> = 5V to 18V) (for V <sub>O</sub> = 24V)	V <sub>I</sub> V <sub>I</sub>	35 40	V V
Thermal Resistance Junction-Cases	R <sub>θJC</sub>	5	°C/W
Thermal Resistance Junction-Air	R <sub>θJA</sub>	65	°C/W
Operating Temperature Range KA78XX/A/R/RA KA78XXI/RI	T <sub>OPR</sub>	0 ~ +125 -40 ~ +125	°C °C
Storage Temperature Range	T <sub>STG</sub>	-65 ~ +150	°C

### LM7805/I/R/RI ELECTRICAL CHARACTERISTICS

(Refer to test circuit, T<sub>MIN</sub> < T<sub>J</sub> < T<sub>MAX</sub>, I<sub>O</sub> = 500mA, V<sub>I</sub> = 10V, C<sub>I</sub> = 0.33μF, C<sub>O</sub> = 0.1μF, unless otherwise specified)

Characteristic	Symbol	Test Conditions	LM7805I			LM7805			Unit
			Min	Typ	Max	Min	Typ	Max	
Output Voltage	V <sub>O</sub>	T <sub>J</sub> = +25°C	4.8	5.0	5.2	4.8	5.0	5.2	V
		5.0mA ≤ I <sub>O</sub> ≤ 1.0A, P <sub>O</sub> ≤ 15W V <sub>I</sub> = 7V to 20V V <sub>I</sub> = 8V to 20V	4.75	5.0	5.25	4.75	5.0	5.25	
Line Regulation	ΔV <sub>O</sub>	T <sub>J</sub> = +25°C	V <sub>O</sub> = 7V to 25V	4.0	100	4.0	100	mV	
			V <sub>I</sub> = 8V to 12V	1.6	50	1.6	50		
Load Regulation	ΔV <sub>O</sub>	T <sub>J</sub> = +25°C	I <sub>O</sub> = 5.0mA to 1.5A	9	100	9	100	mV	
			I <sub>O</sub> = 250mA to 750mA	4	50	4	50		
Quiescent Current	I <sub>Q</sub>	T <sub>J</sub> = +25°C	5.0	8	5.0	8	mA		
Quiescent Current Change	ΔI <sub>Q</sub>	I <sub>O</sub> = 5mA to 1.0A	0.03	0.5	0.03	0.5	mA		
		V <sub>I</sub> = 7V to 25V			0.3	1.3			
		V <sub>I</sub> = 8V to 25V	0.3	1.3					
Output Voltage Drift	ΔV <sub>O</sub> /ΔT	I <sub>O</sub> = 5mA		-0.8		-0.8	mV/°C		
Output Noise Voltage	V <sub>N</sub>	f = 10Hz to 100KHz, T <sub>A</sub> = +25°C	42		42		μV/V <sub>O</sub>		
Ripple Rejection	RR	f = 120Hz V <sub>O</sub> = 8 to 18V	62	73	62	73	dB		
Dropout Voltage	V <sub>O</sub>	I <sub>O</sub> = 1A, T <sub>J</sub> = +25°C	2		2		V		
Output Resistance	R <sub>O</sub>	f = 1KHz	15		15		mΩ		
Short Circuit Current	I <sub>SC</sub>	V <sub>I</sub> = 35V, T <sub>A</sub> = +25°C	230		230		mA		
Peak Current	I <sub>PK</sub>	T <sub>J</sub> = +25°C	2.2		2.2		A		

\* T<sub>MIN</sub> < T<sub>J</sub> < T<sub>MAX</sub>  
 LM78XXI/RI: T<sub>MIN</sub> = -40°C, T<sub>MAX</sub> = +125°C  
 LM78XX/R: T<sub>MIN</sub> = 0°C, T<sub>MAX</sub> = +125°C

\* Load and line regulation are specified at constant junction temperature. Changes in V<sub>O</sub> due to heating effects must be taken into account separately. Pulse testing with low duty is used.

## LM78XX (KA78XX, MC78XX) FIXED VOLTAGE REGULATOR (POSITIVE)

### LM7806I/R/RI ELECTRICAL CHARACTERISTICS

(Refer to test circuit,  $T_{MIN} < T_J < T_{MAX}$ ,  $I_O = 500mA$ ,  $V_I = 11V$   $C_I = 0.33\mu F$ ,  $C_O = 0.1\mu F$ , unless otherwise specified)

Characteristic	Symbol	Test Conditions	LM7806I			LM7806			Unit
			Min	Typ	Max	Min	Typ	Max	
Output Voltage	$V_O$	$T_J = +25^\circ C$	5.75	6.0	6.25	5.75	6.0	6.25	V
		$5.0mA \leq I_O \leq 1.0A$ , $P_D \leq 15W$ $V_I = 8.0V$ to $21V$ $V_I = 9.0V$ to $21V$	5.7	6.0	6.3	5.7	6.0	6.3	
Line Regulation	$\Delta V_O$	$T_J = +25^\circ C$	$V_I = 8V$ to $25V$	5	120	5	120	mV	
			$V_I = 9V$ to $13V$	1.5	60	1.5	60		
Load Regulation	$\Delta V_O$	$T_J = +25^\circ C$	$I_O = 5mA$ to $1.5A$	9	120	9	120	mV	
			$I_O = 250mA$ to $750A$	3	60	3	60		
Quiescent Current	$I_Q$	$T_J = +25^\circ C$		5.0	8	5.0	8	mA	
Quiescent Current Change	$\Delta I_Q$	$T_J = +25^\circ C$	$I_O = 5mA$ to $1A$		0.5		0.5	mA	
			$V_I = 8V$ to $25V$				1.3		
			$V_I = 9V$ to $25V$		1.3				
Output Voltage Drift	$\Delta V_O / \Delta T$	$I_O = 5mA$		-0.8		-0.8		mV/ $^\circ C$	
Output Noise Voltage	$V_N$	$f = 10Hz$ to $100KHz$ , $T_A = +25^\circ C$		45		45		$\mu V / V_O$	
Ripple Rejection	RR	$f = 120Hz$ $V_I = 9V$ to $19V$	59	75		59	75	dB	
Dropout Voltage	$V_D$	$I_O = 1A$ , $T_J = +25^\circ C$		2		2		V	
Output Resistance	$R_D$	$f = 1KHz$		19		19		m $\Omega$	
Short Circuit Current	$I_{SC}$	$V_I = 35V$ , $T_A = +25^\circ C$		250		250		mA	
Peak Current	$I_{PK}$	$T_J = +25^\circ C$		2.2		2.2		A	

\*  $T_{MIN} < T_J < T_{MAX}$

LM78XXI/RI:  $T_{MIN} = -40^\circ C$ ,  $T_{MAX} = +125^\circ C$

LM78XX/R:  $T_{MIN} = 0^\circ C$ ,  $T_{MAX} = +125^\circ C$

\* Load and line regulation are specified at constant, junction temperature. Change in  $V_O$  due to heating effects must be taken into account separately. Pulse testing with low duty is used.

## LM78XX (KA78XX, MC78XX) FIXED VOLTAGE REGULATOR (POSITIVE)

### LM7808I/R/RI ELECTRICAL CHARACTERISTICS

(Refer to test Circuit,  $T_{MIN} < T_J < T_{MAX}$ ,  $I_O = 500mA$ ,  $V_I = 14V$ ,  $C_I = 0.33\mu F$ ,  $C_O = 0.1\mu F$ , unless otherwise specified)

Characteristic	Symbol	Test Conditions	LM7808I			LM7808			Unit	
			Min	Typ	Max	Min	Typ	Max		
Output Voltage	$V_O$	$T_J = +25^\circ C$	7.7	8.0	8.3	7.7	8.0	8.3	V	
		$5.0mA \leq I_O \leq 1.0A$ , $P_O \leq 15W$ $V_I = 10.5V$ to $23V$ $V_I = 11.5V$ to $23V$	7.6	8.0	8.4	7.6	8.0	8.4		
Line Regulation	$\Delta V_O$	$T_J = +25^\circ C$	$V_I = 10.5V$ to $25V$	5.0	160		5.0	160	mV	
			$V_I = 11.5V$ to $17V$	2.0	80		2.0	80		
Load Regulation	$\Delta V_O$	$T_J = +25^\circ C$	$I_O = 5.0mA$ to $1.5A$		10	160		10	160	mV
			$I_O = 250mA$ to $750mA$		5.0	80		5.0	80	
Quiescent Current	$I_Q$	$T_J = +25^\circ C$		5.0	8		5.0	8	mA	
Quiescent Current Change	$\Delta I_Q$	$T_J = +25^\circ C$	$I_O = 5mA$ to $1.0A$		0.05	0.5		0.05	0.5	mA
			$V_I = 10.5A$ to $25V$					0.5	1.0	
			$V_I = 11.5V$ to $25V$		0.5	1.0				
Output Voltage Drift	$\Delta V_O / \Delta T$	$I_O = 5mA$		-0.8			-0.8		mV/ $^\circ C$	
Output Noise Voltage	$V_N$	$f = 10Hz$ to $100KHz$ , $T_A = +25^\circ C$		52			52		$\mu V/V_O$	
Ripple Rejection	RR	$f = 120Hz$ , $V_I = 11.5V$ to $21.5$	56	73		56	73		dB	
Dropout Voltage	$V_D$	$I_O = 1A$ , $T_J = +25^\circ C$		2			2		V	
Output Resistance	$R_O$	$f = 1KHz$		17			17		$m\Omega$	
Short Circuit Current	$I_{SC}$	$V_I = 35V$ , $T_A = +25^\circ C$		230			230		mA	
Peak Current	$I_{PK}$	$T_J = +25^\circ C$		2.2			2.2		A	

\*  $T_{MIN} < T_J < T_{MAX}$

LM78XXI/RI:  $T_{MIN} = -40^\circ C$ ,  $T_{MAX} = +125^\circ C$

LM78XX/R:  $T_{MIN} = 0^\circ C$ ,  $T_{MAX} = +125^\circ C$

\* Load and line regulation are specified at constant, junction temperature. Change in  $V_O$  due to heating effects must be taken into account separately. Pulse testing with low duty is used.

## LM78XX (KA78XX, MC78XX) FIXED VOLTAGE REGULATOR (POSITIVE)

### LM7809/IR/RI ELECTRICAL CHARACTERISTICS

(Refer to test circuit.  $T_{MIN} < T_J < T_{MAX}$ ,  $I_O = 500\text{mA}$ ,  $V_I = 15\text{V}$ ,  $C_1 = 0.33\mu\text{F}$ ,  $C_O = 0.1\mu\text{F}$ , unless otherwise specified)

Characteristic	Symbol	Test Conditions	LM7809I			LM7809			Unit
			Min	Typ	Max	Min	Typ	Max	
Output Voltage	$V_O$	$T_J = +25^\circ\text{C}$	8.65	9	9.35	8.65	9	9.35	V
		$5.0\text{mA} \leq I_O \leq 1.0\text{A}$ , $P_D \leq 15\text{W}$ $V_I = 11.5\text{V to } 24\text{V}$ $V_I = 12.5\text{V to } 24\text{V}$	8.6	9	9.4	8.6	9	9.4	
Line Regulation	$\Delta V_O$	$T_J = +25^\circ\text{C}$	$V_I = 11.5\text{V to } 25\text{V}$	6	180	6	180	mV	
			$V_I = 12\text{V to } 25\text{V}$	2	90	2	90		
Load Regulation	$\Delta V_O$	$T_J = +25^\circ\text{C}$	$I_O = 5\text{mA to } 1.5\text{A}$	12	180	12	180	mV	
			$I_O = 250\text{mA to } 750\text{mA}$	4	90	4	90		
Quiescent Current	$I_Q$	$T_J = +25^\circ\text{C}$	5.0	8	5.0	8	mA		
Quiescent Current Change	$\Delta I_Q$	$T_J = +25^\circ\text{C}$	$I_O = 5\text{mA to } 1.0\text{A}$		0.5		0.5	mA	
			$V_I = 11.5\text{V to } 26\text{V}$				1.3		
			$V_I = 12.5\text{V to } 26\text{V}$		1.3				
Output Voltage Drift	$\Delta V_O / \Delta T$	$I_O = 5\text{mA}$		-1		-1	mV/ $^\circ\text{C}$		
Output Noise Voltage	$V_N$	$f = 10\text{Hz to } 100\text{kHz}$ , $T_A = +25^\circ\text{C}$		58		58	$\mu\text{V}/V_O$		
Ripple Rejection	RR	$f = 120\text{Hz}$ $V_I = 13\text{V to } 23\text{V}$	56	71	56	71	dB		
Dropout Voltage	$V_D$	$I_O = 1\text{A}$ , $T_J = +25^\circ\text{C}$		2		2	V		
Output Resistance	$R_O$	$f = 1\text{KHz}$		17		17	$\text{m}\Omega$		
Short Circuit Current	$I_{SC}$	$V_I = 35\text{V}$ , $T_A = +25^\circ\text{C}$		250		250	mA		
Peak Current	$I_{PK}$	$T_J = +25^\circ\text{C}$		2.2		2.2	A		

\*  $T_{MIN} < T_J < T_{MAX}$

LM78XXI/RI:  $T_{MIN} = -40^\circ\text{C}$ ,  $T_{MAX} = +125^\circ\text{C}$

LM78XX/R:  $T_{MIN} = 0^\circ\text{C}$ ,  $T_{MAX} = +125^\circ\text{C}$

\* Load and line regulation are specified at constant, junction temperature. Change in  $V_O$  due to heating effects must be taken into account separately. Pulse testing with low duty is used.

## LM78XX (KA78XX, MC78XX) FIXED VOLTAGE REGULATOR (POSITIVE)

### LM7810//R/RI ELECTRICAL CHARACTERISTICS

(Refer to test circuit,  $T_{MIN} < T_J < T_{MAX}$ ,  $I_O = 500\text{mA}$ ,  $V_I = 16\text{V}$ ,  $C_I = 0.33\mu\text{F}$ ,  $C_O = 0.1\mu\text{F}$ , unless otherwise specified)

Characteristic	Symbol	Test Conditions	LM7810I			LM7810			Unit
			Min	Typ	Max	Min	Typ	Max	
Output Voltage	$V_O$	$T_J = +25^\circ\text{C}$	9.6	10	10.4	9.6	10	10.4	V
		$5.0\text{mA} \leq I_O \leq 1.0\text{A}$ , $P_D \leq 15\text{W}$ $V_I = 12.5\text{V to } 25\text{V}$ $V_I = 13.5\text{V to } 25\text{V}$	9.5	10	10.5	9.5	10	10.5	
Line Regulation	$\Delta V_O$	$T_J = +25^\circ\text{C}$	$V_I = 12.5\text{V to } 25\text{V}$	10	200	10	200	mV	
			$V_I = 13\text{V to } 25\text{V}$	3	100	3	100		
Load Regulation	$\Delta V_O$	$T_J = +25^\circ\text{C}$	$I_O = 5\text{mA to } 1.5\text{A}$	12	200	12	200	mV	
			$I_O = 250\text{mA to } 750\text{mA}$	4	400	4	400		
Quiescent Current	$I_Q$	$T_J = +25^\circ\text{C}$	5.1	8	5.1	8	mA		
Quiescent Current Change	$\Delta I_Q$	$I_O = 5\text{mA to } 1.0\text{A}$	$V_I = 12.5\text{V to } 29\text{V}$				0.5	mA	
			$V_I = 13.5\text{V to } 29\text{V}$		1.0				
Output Voltage Drift	$\Delta V_O / \Delta T$	$I_O = 5\text{mA}$	-1		-1		mV/°C		
Output Noise Voltage	$V_N$	$f = 10\text{Hz to } 100\text{KHz}$ , $T_A = +25^\circ\text{C}$	58		58		$\mu\text{V}/V_O$		
Ripple Rejection	RR	$f = 120\text{Hz}$ $V_I = 13\text{V to } 23\text{V}$	56	71	56	71	dB		
Dropout Voltage	$V_D$	$I_O = 1\text{A}$ , $T_J = +25^\circ\text{C}$	2		2		V		
Output Resistance	$R_O$	$f = 1\text{KHz}$	17		17		m $\Omega$		
Short Circuit Current	$I_{SC}$	$V_I = 35\text{V}$ , $T_A = +25^\circ\text{C}$	250		250		mA		
Peak Current	$I_{PK}$	$T_J = +25^\circ\text{C}$	2.2		2.2		A		

\*  $T_{MIN} < T_J < T_{MAX}$

LM78XXI/RI:  $T_{MIN} = -40^\circ\text{C}$ ,  $T_{MAX} = +125^\circ\text{C}$

LM78XX/R:  $T_{MIN} = 0^\circ\text{C}$ ,  $T_{MAX} = +125^\circ\text{C}$

\* Load and line regulation are specified at constant, junction temperature. Change in  $V_O$  due to heating effects must be taken into account separately. Pulse testing with low duty is used.

## LM78XX (KA78XX, MC78XX) FIXED VOLTAGE REGULATOR (POSITIVE)

### LM7811//R/RI ELECTRICAL CHARACTERISTICS

(Refer to test circuit,  $T_{MIN} < T_J < T_{MAX}$ ,  $I_O = 500mA$ ,  $V_I = 18V$ ,  $C_I = 0.33\mu F$ ,  $C_O = 0.1\mu F$ , unless otherwise specified)

Characteristic	Symbol	Test Conditions	LM7811I			LM7811			Unit
			Min	Typ	Max	Min	Typ	Max	
Output Voltage	$V_O$	$T_J = +25^\circ C$	10.6	11	11.4	10.6	11	11.4	V
		$5.0mA \leq I_O \leq 1.0A$ , $P_D \leq 15W$ $V_I = 13.5V$ to $26V$ $V_I = 14.5V$ to $26V$	10.5	11	11.5	10.5	11	11.5	
Line Regulation	$\Delta V_O$	$T_J = +25^\circ C$	$V_I = 13.5V$ to $25V$	10	220	10	220	mV	
			$V_I = 14V$ to $21V$	3.0	110	3	110		
Load Regulation	$\Delta V_O$	$T_J = +25^\circ C$	$I_O = 5.0mA$ to $1.5A$	12	220	12	220	mV	
			$I_O = 250mA$ to $750mA$	4	110	4	110		
Quiescent Current	$I_Q$	$T_J = +25^\circ C$	5.1	8	5.1	8	mA		
Quiescent Current Change	$\Delta I_Q$	$T_J = +25^\circ C$	$I_O = 5mA$ to $1.0A$		0.5		0.5	mA	
			$V_I = 13.5V$ to $29V$				1.0		
			$V_I = 14.5V$ to $29V$		1.0				
Output Voltage Drift	$\Delta V_O / \Delta T$	$I_O = 5mA$	-1		-1		mV/°C		
Output Noise Voltage	$V_N$	$f = 10Hz$ to $100KHz$ , $T_A = +25^\circ C$	70		70		$\mu V / V_O$		
Ripple Rejection	RR	$f = 120Hz$ $V_I = 14V$ to $24V$	55	71	55	71	dB		
Dropout Voltage	$V_D$	$I_O = 1A$ , $T_J = +25^\circ C$	2		2		V		
Output Resistance	$R_O$	$f = 1KHz$	18		18		m $\Omega$		
Short Circuit Current	$I_{SC}$	$V_I = 35V$ , $T_A = +25^\circ C$	250		250		mA		
Peak Current	$I_{PK}$	$T_J = +25^\circ C$	2.2		2.2		A		

\*  $T_{MIN} < T_J < T_{MAX}$

LM78XXI/RI:  $T_{MIN} = -40^\circ C$ ,  $T_{MAX} = +125^\circ C$

LM78XXR:  $T_{MIN} = 0^\circ C$ ,  $T_{MAX} = +125^\circ C$

\* Load and line regulation are specified at constant, junction temperature. Change in  $V_O$  due to heating effects must be taken into account separately. Pulse testing with low duty is used.

## LM78XX (KA78XX, MC78XX) FIXED VOLTAGE REGULATOR (POSITIVE)

### LM7812//R/RI ELECTRICAL CHARACTERISTICS

(Refer to test circuit,  $T_{MIN} < T_J < T_{MAX}$ ,  $I_O = 500\text{mA}$ ,  $V_I = 19\text{V}$ ,  $C_I = 0.33\mu\text{F}$ ,  $C_O = 0.1\mu\text{F}$ , unless otherwise specified)

Characteristic	Symbol	Test Conditions	LM7812I			LM7812			Unit
			Min	Typ	Max	Min	Typ	Max	
Output Voltage	$V_O$	$T_J = +25^\circ\text{C}$	11.5	12	12.5	11.5	12	12.5	V
		$5.0\text{mA} \leq I_O \leq 1.0\text{A}$ , $P_D \leq 15\text{W}$ $V_I = 14.5\text{V to } 27\text{V}$ $V_I = 15.5\text{V to } 27\text{V}$	11.4	12	12.6	11.4	12	12.6	
Line Regulation	$\Delta V_O$	$T_J = +25^\circ\text{C}$	$V_I = 14.5\text{V to } 30\text{V}$	10	240	10	240	mV	
			$V_I = 16\text{V to } 22\text{V}$	3.0	120	3.0	120		
Load Regulation	$\Delta V_O$	$T_J = +25^\circ\text{C}$	$I_O = 5\text{mA to } 1.5\text{A}$	11	240	11	240	mV	
			$I_O = 250\text{mA to } 750\text{mA}$	5.0	120	5.0	120		
Quiescent Current	$I_Q$	$T_J = +25^\circ\text{C}$	5.1	8	5.1	8	mA		
Quiescent Current Change	$\Delta I_Q$	$T_J = +25^\circ\text{C}$	$I_O = 5\text{mA to } 1.0\text{A}$	0.1	0.5	0.1	0.5	mA	
			$V_I = 14.5\text{V to } 30\text{V}$			0.5	1.0		
			$V_I = 15\text{V to } 30\text{V}$		1.0				
Output Voltage Drift	$\Delta V_O / \Delta T$	$I_O = 5\text{mA}$	0.5	-1		-1	mV/ $^\circ\text{C}$		
Output Noise Voltage	$V_N$	$f = 10\text{Hz to } 100\text{KHz}$ , $T_A = +25^\circ\text{C}$		76		76	mV/ $V_O$		
Ripple Rejection	RR	$f = 120\text{Hz}$ $V_I = 15\text{V to } 25\text{V}$	55	71		55	71	dB	
Dropout Voltage	$V_D$	$I_O = 1\text{A}$ , $T_J = +25^\circ\text{C}$		2		2	V		
Output Resistance	$R_O$	$f = 1\text{KHz}$		18		18	m $\Omega$		
Short Circuit Current	$I_{SC}$	$V_I = 35\text{V}$ , $T_A = +25^\circ\text{C}$		230		230	mA		
Peak Current	$I_{PK}$	$T_J = +25^\circ\text{C}$		2.2		2.2	A		

$T_{MIN} < T_J < T_{MAX}$

LM78XXI/RI:  $T_{MIN} = -40^\circ\text{C}$ ,  $T_{MAX} = +125^\circ\text{C}$

LM78XX/R:  $T_{MIN} = 0^\circ\text{C}$ ,  $T_{MAX} = +125^\circ\text{C}$

\* Load and line regulation are specified at constant, junction temperature. Change in  $V_O$  due to heating effects must be taken into account separately. Pulse testing with low duty is used.



## LM78XX (KA78XX, MC78XX) FIXED VOLTAGE REGULATOR (POSITIVE)

### LM7815I/R/RI ELECTRICAL CHARACTERISTICS

(Refer to test circuit,  $T_{MIN} < T_J < T_{MAX}$ ,  $I_O = 500\text{mA}$ ,  $V_I = 23\text{V}$ ,  $C_1 = 0.33\mu\text{F}$ ,  $C_O = 0.1\mu\text{F}$ , unless otherwise specified)

Characteristic	Symbol	Test Conditions	LM7815I			LM7815			Unit
			Min	Typ	Max	Min	Typ	Max	
Output Voltage	$V_O$	$T_J = +25^\circ\text{C}$	14.4	15	15.6	14.4	15	15.6	V
		$5.0\text{mA} \leq I_O \leq 1.0\text{A}$ , $P_D \leq 15\text{W}$ $V_I = 17.5\text{V to } 30\text{V}$ $V_I = 18.5\text{V to } 30\text{V}$	14.2 5	15	15.75	14.25	15	15.75	
Line Regulation	$\Delta V_O$	$T_J = +25^\circ\text{C}$							mV
		$V_I = 17.5\text{V to } 30\text{V}$ $V_I = 20\text{V to } 26\text{V}$		11 3	300 150		11 3	300 150	
Load Regulation	$\Delta V_O$	$T_J = +25^\circ\text{C}$							mV
		$I_O = 5\text{mA to } 1.5\text{A}$ $I_O = 250\text{mA to } 750\text{mA}$		12 4	300 150		12 4	300 150	
Quiescent Current	$I_Q$	$T_J = +25^\circ\text{C}$		5.2	8		5.2	8	mA
Quiescent Current Change	$\Delta I_Q$	$I_O = 5\text{mA to } 1.0\text{A}$			0.5			0.5	mA
		$V_I = 17.5\text{V to } 30\text{V}$						1.0	
		$V_I = 18.5\text{V to } 30\text{V}$			1.0				
Output Voltage Drift	$\Delta V_O / \Delta T$	$I_O = 5\text{mA}$		-1			-1		mV/ $^\circ\text{C}$
Output Noise Voltage	$V_N$	$f = 10\text{Hz to } 100\text{KHz}$ , $T_A = +25^\circ\text{C}$		90			90		$\mu\text{V}/V_O$
Ripple Rejection	RR	$f = 120\text{Hz}$ $V_I = 18.5\text{V to } 28.5\text{V}$	54	70		54	70		dB
Dropout Voltage	$V_D$	$I_O = 1\text{A}$ , $T_J = +25^\circ\text{C}$		2			2		V
Output Resistance	$R_O$	$f = 1\text{KHz}$		19			19		$\text{m}\Omega$
Short Circuit Current	$I_{SC}$	$V_I = 35\text{V}$ , $T_A = +25^\circ\text{C}$		250			250		mA
Peak Current	$I_{PK}$	$T_J = +25^\circ\text{C}$		2.2			2.2		A

\*  $T_{MIN} < T_J < T_{MAX}$

LM78XXI/RI:  $T_{MIN} = -40^\circ\text{C}$ ,  $T_{MAX} = +125^\circ\text{C}$

LM78XX/R:  $T_{MIN} = 0^\circ\text{C}$ ,  $T_{MAX} = +125^\circ\text{C}$

\* Load and line regulation are specified at constant, junction temperature. Change in  $V_O$  due to heating effects must be taken into account separately. Pulse testing with low duty is used.

## LM78XX (KA78XX, MC78XX) FIXED VOLTAGE REGULATOR (POSITIVE)

### LM7818/1R/RI ELECTRICAL CHARACTERISTICS

(Refer to test circuit,  $T_{MIN} < T_J < T_{MAX}$ ,  $I_O = 500mA$ ,  $V_I = 27V$ ,  $C_I = 0.33\mu F$ ,  $C_O = 0.1\mu F$ , unless otherwise specified)

Characteristic	Symbol	Test Conditions	LM7818I			LM7818			Unit
			Min	Typ	Max	Min	Typ	Max	
Output Voltage	$V_O$	$T_J = +25^\circ C$	17.3	18	18.7	17.3	18	18.7	V
		$5.0mA \leq I_O \leq 1.0A$ , $P_D \leq 15W$ $V_I = 21V$ to $33V$ $V_I = 22V$ to $33V$	17.1	18	18.9	17.1	18	18.9	
Line Regulation	$\Delta V_O$	$T_J = +25^\circ C$	$V_I = 21V$ to $33V$	15	360	15	360	mV	
			$V_I = 24V$ to $30V$	5	180	5	180		
Load Regulation	$\Delta V_O$	$T_J = +25^\circ C$	$I_O = 5mA$ to $1.5A$ $I_O = 250mA$ to $750mA$	15 5.0	360 180	15 5.0	360 180	mV	
Quiescent Current	$I_Q$	$T_J = +25^\circ C$		5.2	8	5.2	8	mA	
Quiescent Current Change	$\Delta I_Q$	$T_J = +25^\circ C$	$I_O = 5mA$ to $1.0A$		0.5		0.5	mA	
			$V_I = 21V$ to $33V$				1		
			$V_I = 22V$ to $33V$		1.0				
Output Voltage Drift	$\Delta V_O / \Delta T$	$I_O = 5mA$		-1		-1		mV/°C	
Output Noise Voltage	$V_N$	$f = 10Hz$ to $100KHz$ , $T_A = +25^\circ C$		110		110		$\mu V / V_O$	
Ripple Rejection	RR	$f = 120Hz$ $V_I = 22V$ to $32V$	53	69		53	69	dB	
Dropout Voltage	$V_D$	$I_O = 1A$ , $T_J = +25^\circ C$		2		2		V	
Output Resistance	$R_O$	$f = 1KHz$		22		22		$m\Omega$	
Short Circuit Current	$I_{SC}$	$V_I = 35V$ , $T_A = +25^\circ C$		250		250		mA	
Peak Current	$I_{PK}$	$T_J = +25^\circ C$		2.2		2.2		A	

\*  $T_{MIN} < T_J < T_{MAX}$

LM78XXI/RI:  $T_{MIN} = -40^\circ C$ ,  $T_{MAX} = +125^\circ C$

LM78XX/R:  $T_{MIN} = 0^\circ C$ ,  $T_{MAX} = +125^\circ C$

\* Load and line regulation are specified at constant, junction temperature. Change in  $V_O$  due to heating effects must be taken into account separately. Pulse testing with low duty is used.

## LM78XX (KA78XX, MC78XX) FIXED VOLTAGE REGULATOR (POSITIVE)

### LM7824/IR/RI ELECTRICAL CHARACTERISTICS

(Refer to test circuit,  $T_{MIN} < T_J < T_{MAX}$ ,  $I_O = 500\text{mA}$ ,  $V_I = 33\text{V}$ ,  $C_I = 0.33\mu\text{F}$ ,  $C_O = 0.1\mu\text{F}$ , unless otherwise specified)

Characteristic	Symbol	Test Conditions	LM7824I			LM7824			Unit
			Min	Typ	Max	Min	Typ	Max	
Output Voltage	$V_O$	$T_J = +25^\circ\text{C}$	23	24	25	23	24	25	V
		$5.0\text{mA} \leq I_O \leq 1.0\text{A}$ , $P_D \leq 15\text{W}$ $V_I = 27\text{V to } 38\text{V}$ $V_I = 28\text{V to } 38\text{V}$	22.8	24	25.2	22.8	24	25.25	
Line Regulation	$\Delta V_O$	$T_J = +25^\circ\text{C}$	$V_I = 27\text{V to } 38\text{V}$	17	480		17	480	mV
			$V_I = 30\text{V to } 36\text{V}$	6	240		6	240	
Load Regulation	$\Delta V_O$	$T_J = +25^\circ\text{C}$	$I_O = 5\text{mA to } 1.5\text{A}$	15	480		15	480	mV
			$I_O = 250\text{mA to } 750\text{mA}$	5.0	240		5.0	240	
Quiescent Current	$I_Q$	$T_J = +25^\circ\text{C}$		5.2	8		5.2	8	mA
Quiescent Current Change	$\Delta I_Q$	$T_J = +25^\circ\text{C}$	$I_O = 5\text{mA to } 1.0\text{A}$	0.1	0.5		0.1	0.5	mA
			$V_I = 27\text{V to } 38\text{V}$				0.5	1	
			$V_I = 28\text{V to } 38\text{V}$	0.5	1				
Output Voltage Drift	$\Delta V_O/\Delta T$	$I_O = 5\text{mA}$		-1.5			-1.5		mV/ $^\circ\text{C}$
Output Noise Voltage	$V_N$	$f = 10\text{Hz to } 100\text{KHz}$ , $T_A = +25^\circ\text{C}$		160			60		$\mu\text{V}/V_O$
Ripple Rejection	RR	$f = 120\text{Hz}$ $V_I = 28\text{V to } 38\text{V}$	50	67		50	67		dB
Dropout Voltage	$V_D$	$I_O = 1\text{A}$ , $T_J = +25^\circ\text{C}$		2			2		V
Output Resistance	$R_O$	$f = 1\text{KHz}$		28			28		$\text{m}\Omega$
Short Circuit Current	$I_{SC}$	$V_I = 35\text{V}$ , $T_A = +25^\circ\text{C}$		230			230		mA
Peak Current	$I_{PK}$	$T_J = +25^\circ\text{C}$		2.2			2.2		A

\*  $T_{MIN} < T_J < T_{MAX}$

LM78XXI/RI:  $T_{MIN} = -40^\circ\text{C}$ ,  $T_{MAX} = +125^\circ\text{C}$

LM78XX/R:  $T_{MIN} = 0^\circ\text{C}$ ,  $T_{MAX} = +125^\circ\text{C}$

\* Load and line regulation are specified at constant, junction temperature. Change in  $V_O$  due to heating effects must be taken into account separately. Pulse testing with low duty is used.

## LM78XX (KA78XX, MC78XX) FIXED VOLTAGE REGULATOR (POSITIVE)

### LM7805A/RA ELECTRICAL CHARACTERISTICS

(Refer to the test circuits.  $T_J = 0$  to  $+125^\circ\text{C}$ ,  $I_O = 1\text{A}$ ,  $V_I = 10\text{V}$ ,  $C_I = 0.33\mu\text{F}$ ,  $C_O = 0.1\mu\text{F}$ , unless otherwise specified)

Characteristic	Symbol	Test Conditions	Min	Typ	Max	Unit
Output Voltage	$V_O$	$T_J = +25^\circ\text{C}$	4.9	5	5.1	V
		$I_O = 5\text{mA}$ to $1\text{A}$ , $P_D \leq 5\text{W}$ $V_I = 7.5$ to $20\text{V}$	4.8	5	5.2	
Line Regulation	$\Delta V_O$	$V_I = 7.5$ to $25\text{V}$ $I_O = 500\text{mA}$		5	50	V
		$V_I = 8\text{V}$ to $12\text{V}$		3	50	
		$T_J = +25^\circ\text{C}$	$V_I = 7.3\text{V}$ to $25\text{V}$ $V_I = 8\text{V}$ to $12\text{V}$		5 1.5	
Load Regulation	$\Delta V_O$	$T_J = +25^\circ\text{C}$ $I_O = 5\text{mA}$ to $1.5\text{A}$		9	100	V
		$I_O = 5\text{mA}$ to $1\text{A}$		9	100	
		$I_O = 250$ to $750\text{mA}$		4	50	
Quiescent Current	$I_Q$	$T_J = +25^\circ\text{C}$		5.0	6	mA
Quiescent Current Change	$\Delta I_Q$	$I_O = 5\text{mA}$ to $1\text{A}$			0.5	mA
		$V_I = 8\text{V}$ to $25\text{V}$ , $I_O = 500\text{mA}$			0.8	
		$V_I = 7.5\text{V}$ to $20\text{V}$ , $T_J = +25^\circ\text{C}$			0.8	
Output Voltage Drift	$\Delta V/\Delta T$	$I_O = 5\text{mA}$		-0.8		mV/ $^\circ\text{C}$
Output Noise Voltage	$V_N$	$f = 10\text{Hz}$ to $100\text{KHz}$ $T_A = +25^\circ\text{C}$		10		$\mu\text{V}/V_O$
Ripple Rejection	RR	$f = 120\text{Hz}$ , $I_O = 500\text{mA}$ $V_I = 8\text{V}$ to $18\text{V}$		68		dB
Dropout Voltage	$V_D$	$I_O = 1\text{A}$ , $T_J = +25^\circ\text{C}$		2		V
Output Resistance	$R_O$	$f = 1\text{KHz}$		17		$\text{m}\Omega$
Short Circuit Current	$I_{SC}$	$V_I = 35\text{V}$ , $T_A = +25^\circ\text{C}$		250		mA
Peak Current	$I_{PK}$	$T_J = +25^\circ\text{C}$		2.2		A

\*Load and line regulation are specified at constant junction temperature. Change in  $V_O$  due to heating effects must be taken into account separately. Pulse testing with low duty is used.

## LM78XX (KA78XX, MC78XX) FIXED VOLTAGE REGULATOR (POSITIVE)

### LM7806A/RA ELECTRICAL CHARACTERISTICS

(Refer to the test circuits.  $T_J = 0$  to  $+150^\circ\text{C}$ ,  $I_O = 1\text{A}$ ,  $V_I = 11\text{V}$ ,  $C_I = 0.33\mu\text{F}$ ,  $C_O = 0.1\mu\text{F}$ , unless otherwise specified)

Characteristic	Symbol	Test Conditions	Min	Typ	Max	Unit
Output Voltage	$V_O$	$T_J = +25^\circ\text{C}$	5.58	6	6.12	V
		$I_O = 5\text{mA to } 1\text{A}$ , $P_D \leq 15\text{W}$ $V_I = 8.6$ to $21\text{V}$	5.76	6	6.24	
Line Regulation	$\Delta V_O$	$V_I = 8.6$ to $25\text{V}$ $I_O = 500\text{mA}$		5	60	mV
		$V_I = 9\text{V to } 13\text{V}$		3	60	
		$T_J = +25^\circ\text{C}$	$V_I = 8.3\text{V to } 21\text{V}$ $V_I = 9\text{V to } 13\text{V}$		5 1.5	
Load Regulation	$\Delta V_O$	$T_J = +25^\circ\text{C}$ $I_O = 5\text{mA to } 1.5\text{A}$		9	100	mV
		$I_O = 5\text{mA to } 1\text{A}$		4	100	
		$I_O = 250$ to $750\text{mA}$		5.0	50	
Quiescent Current	$I_Q$	$T_J = +25^\circ\text{C}$		4.3	6	mA
Quiescent Current Change	$\Delta I_Q$	$I_O = 5\text{mA to } 1\text{A}$			0.5	mA
		$V_I = 9\text{V to } 25\text{V}$ , $I_O = 500\text{mA}$			0.8	
		$V_I = 8.5\text{V to } 21\text{V}$ , $T_J = +25^\circ\text{C}$			0.8	
Output Voltage Drift	$\Delta V/\Delta T$	$I_O = 5\text{mA}$		-0.8		mV/ $^\circ\text{C}$
Output Noise Voltage	$V_N$	$f = 10\text{Hz to } 100\text{KHz}$ $T_A = +25^\circ\text{C}$		10		$\mu\text{V}/V_O$
Ripple Rejection	RR	$f = 120\text{Hz}$ , $I_O = 500\text{mA}$ $V_I = 9\text{V to } 19\text{V}$		65		dB
Dropout Voltage	$V_D$	$I_O = 1\text{A}$ , $T_J = +25^\circ\text{C}$		2		V
Output Resistance	$R_O$	$f = 1\text{KHz}$		17		$\text{m}\Omega$
Short Circuit Current	$I_{SC}$	$V_I = 35\text{V}$ , $T_A = +25^\circ\text{C}$		250		mA
Peak Current	$I_{PK}$	$T_J = +25^\circ\text{C}$		2.2		A

\* Load and line regulation are specified at constant, junction temperature. Change in  $V_O$  due to heating effects must be taken into account separately. Pulse testing with low duty is used.

## LM78XX (KA78XX, MC78XX) FIXED VOLTAGE REGULATOR (POSITIVE)

### LM7808A/RA ELECTRICAL CHARACTERISTICS

(Refer to the test circuits.  $T_J = 0$  to  $+150^\circ\text{C}$ ,  $I_O = 1\text{A}$ ,  $V_I = 14\text{V}$ ,  $C_I = 0.33\mu\text{F}$ ,  $C_O = 0.1\mu\text{F}$ , unless otherwise specified)

Characteristic	Symbol	Test Conditions	Min	Typ	Max	Unit
Output Voltage	$V_O$	$T_J = +25^\circ\text{C}$	7.84	8	8.16	V
		$I_O = 5\text{mA}$ to $1\text{A}$ , $P_D \leq 15\text{W}$ $V_I = 8.6$ to $21\text{V}$	7.7	8	8.3	
Line Regulation	$\Delta V_O$	$V_I = 10.6$ to $25\text{V}$ $I_O = 500\text{mA}$		6	80	mV
		$V_I = 11$ to $17\text{V}$		3	80	
		$T_J = +25^\circ\text{C}$	$V_I = 10.4\text{V}$ to $23\text{V}$ $V_I = 11\text{V}$ to $17\text{V}$		6 2	
Load Regulation	$\Delta V_O$	$T_J = +25^\circ\text{C}$ $I_O = 5\text{mA}$ to $1.5\text{A}$		12	100	mV
		$I_O = 5\text{mA}$ to $1\text{A}$		12	100	
		$I_O = 250$ to $750\text{mA}$		5	50	
Quiescent Current	$I_Q$	$T_J = +25^\circ\text{C}$		5.0	6	mA
Quiescent Current Change	$\Delta I_Q$	$I_O = 5\text{mA}$ to $1\text{A}$			0.5	mA
		$V_I = 11\text{V}$ to $25\text{V}$ , $I_O = 500\text{mA}$			0.8	
		$V_I = 10.6\text{V}$ to $23\text{V}$ , $T_J = +25^\circ\text{C}$			0.8	
Output Voltage Drift	$\Delta V/\Delta T$	$I_O = 5\text{mA}$		-0.8		mV/ $^\circ\text{C}$
Output Noise Voltage	$V_N$	$f = 10\text{Hz}$ to $100\text{KHz}$ $T_A = +25^\circ\text{C}$		10		$\mu\text{V}/V_O$
Ripple Rejection	RR	$f = 120\text{Hz}$ , $I_O = 500\text{mA}$ $V_I = 11.5\text{V}$ to $21.5\text{V}$		62		dB
Dropout Voltage	$V_D$	$I_O = 1\text{A}$ , $T_J = +25^\circ\text{C}$		2		V
Output Resistance	$R_O$	$f = 1\text{KHz}$		18		$\text{m}\Omega$
Short Circuit Current	$I_{SC}$	$V_I = 35\text{V}$ , $T_A = +25^\circ\text{C}$		250		mA
Peak Current	$I_{PK}$	$T_J = +25^\circ\text{C}$		2.2		A

\* Load and line regulation are specified at constant junction temperature. Change in  $V_O$  due to heating effects must be taken into account separately. Pulse testing with low duty is used.

## LM78XX (KA78XX, MC78XX) FIXED VOLTAGE REGULATOR (POSITIVE)

### LM7809A/RA ELECTRICAL CHARACTERISTICS

(Refer to the test circuits.  $T_J = 0$  to  $+125$  °C,  $I_O = 1A$ ,  $V_I = 15V$ ,  $C_I = 0.33\mu F$ ,  $C_O = 0.1\mu F$ , unless otherwise specified)

Characteristic	Symbol	Test Conditions	Min	Typ	Max	Unit
Output Voltage	$V_O$	$T_J = +25$ °C	8.82	9.0	9.18	V
		$I_O = 5mA$ to $1A$ , $P_D \leq 15W$ $V_I = 11.2$ to $24V$	8.65	9.0	9.35	
Line Regulation	$\Delta V_O$	$V_I = 11.7$ to $25V$ $I_O = 500mA$		6	90	mV
		$V_I = 12.5$ to $19V$		4	45	
		$T_J = +25$ °C $V_I = 11.5V$ to $24V$		6	90	
		$V_I = 12.5V$ to $19V$		2	45	
Load Regulation	$\Delta V_O$	$T_J = +25$ °C $I_O = 5mA$ to $1.0A$		12	100	mV
		$I_O = 5mA$ to $1.0A$		12	100	
		$I_O = 250$ to $750mA$		5	50	
Quiescent Current	$I_Q$	$T_J = +25$ °C		5.0	6.0	mA
Quiescent Current Change	$\Delta I_Q$	$V_I = 11.7V$ to $25V$ , $T_J = +25$ °C			0.8	mA
		$V_I = 12V$ to $25V$ , $I_O = 500mA$			0.8	
		$I_O = 5mA$ to $1.0A$			0.5	
Output Voltage Drift	$\Delta V/\Delta T$	$I_O = 5mA$		-1.0		mV/°C
Output Noise Voltage	$V_N$	$f = 10Hz$ to $100KHz$ $T_A = +25$ °C		10		$\mu V/V_O$
Ripple Rejection	RR	$f = 120Hz$ , $I_O = 500mA$ $V_I = 12V$ to $22V$		62		dB
Dropout Voltage	$V_D$	$I_O = 1A$ , $T_J = +25$ °C		2.0		V
Output Resistance	$R_O$	$f = 1KHz$		17		m $\Omega$
Short Circuit Current	$I_{SC}$	$V_I = 35V$ , $T_A = +25$ °C		250		mA
Peak Current	$I_{PK}$	$T_J = +25$ °C		2.2		A

\* Load and line regulation are specified at constant, junction temperature. Change in  $V_O$  due to heating effects must be taken into account separately. Pulse testing with low duty is used.

## LM78XX (KA78XX, MC78XX) FIXED VOLTAGE REGULATOR (POSITIVE)

### LM7810A/RA ELECTRICAL CHARACTERISTICS

(Refer to the test circuits.  $T_J = 0$  to  $+125^\circ\text{C}$ ,  $I_O = 1\text{A}$ ,  $V_I = 16\text{V}$ ,  $C_I = 0.33\mu\text{F}$ ,  $C_O = 0.1\mu\text{F}$ , unless otherwise specified)

Characteristic	Symbol	Test Conditions	Min	Typ	Max	Unit	
Output Voltage	$V_O$	$T_J = +25^\circ\text{C}$	9.8	10	10.2	V	
		$I_O = 5\text{mA}$ to $1\text{A}$ , $P_D \leq 15\text{W}$ $V_I = 12.8$ to $25\text{V}$	9.6	10	10.4		
Line Regulation	$\Delta V_O$	$V_I = 12.8$ to $26\text{V}$ $I_O = 500\text{mA}$		8	100	mV	
		$V_I = 13$ to $20\text{V}$		4	50		
		$T_J = +25^\circ\text{C}$	$V_I = 12.5\text{V}$ to $25\text{V}$		8		100
			$V_I = 13\text{V}$ to $20\text{V}$		3		50
Load Regulation	$\Delta V_O$	$T_J = +25^\circ\text{C}$ $I_O = 5\text{mA}$ to $1.5\text{A}$		12	100	mV	
		$I_O = 5\text{mA}$ to $1.0\text{A}$		12	100		
		$I_O = 250$ to $750\text{mA}$		5	50		
Quiescent Current	$I_Q$	$T_J = +25^\circ\text{C}$		5.0	6.0	mA	
Quiescent Current Change	$\Delta I_Q$	$V_I = 13\text{V}$ to $26\text{V}$ , $T_J = +25^\circ\text{C}$			0.5	mA	
		$V_I = 12.8\text{V}$ to $25\text{V}$ , $I_O = 500\text{mA}$			0.8		
		$I_O = 5\text{mA}$ to $1.0\text{A}$			0.5		
Output Voltage Drift	$\Delta V/\Delta T$	$I_O = 5\text{mA}$		-1.0		mV/°C	
Output Noise Voltage	$V_N$	$f = 10\text{Hz}$ to $100\text{KHz}$ $T_A = +25^\circ\text{C}$		10		$\mu\text{V}/V_O$	
Ripple Rejection	RR	$f = 120\text{Hz}$ , $I_O = 500\text{mA}$ $V_I = 14\text{V}$ to $24\text{V}$		62		dB	
Dropout Voltage	$V_D$	$I_O = 1\text{A}$ , $T_J = +25^\circ\text{C}$		2.0		V	
Output Resistance	$R_O$	$f = 1\text{KHz}$		17		m $\Omega$	
Short Circuit Current	$I_{SC}$	$V_I = 35\text{V}$ , $T_A = +25^\circ\text{C}$		250		mA	
Peak Current	$I_{PK}$	$T_J = +25^\circ\text{C}$		2.2		A	

\* Load and line regulation are specified at constant, junction temperature. Change in  $V_O$  due to heating effects must be taken into account separately. Pulse testing with low duty is used.



## LM78XX (KA78XX, MC78XX) FIXED VOLTAGE REGULATOR (POSITIVE)

### LM7811A/RA ELECTRICAL CHARACTERISTICS

(Refer to the test circuits.  $T_J = 0$  to  $+125^\circ\text{C}$ ,  $I_O = 1\text{A}$ ,  $V_I = 18\text{V}$ ,  $C_I = 0.33\mu\text{F}$ ,  $C_O = 0.1\mu\text{F}$ , unless otherwise specified)

Characteristic	Symbol	Test Conditions	Min	Typ	Max	Unit
Output Voltage	$V_O$	$T_J = +25^\circ\text{C}$	10.8	11.0	11.2	V
		$I_O = 5\text{mA}$ to $1\text{A}$ , $P_D \leq 15\text{W}$ $V_I = 13.8$ to $26\text{V}$	10.6	11.0	11.4	
Line Regulation	$\Delta V_O$	$V_I = 12.8$ to $26\text{V}$ $I_O = 500\text{mA}$		10	110	mV
		$V_I = 15$ to $21\text{V}$		4	55	
		$T_J = +25^\circ\text{C}$	$V_I = 13.5\text{V}$ to $26\text{V}$ $V_I = 15\text{V}$ to $21\text{V}$		10 3	
Load Regulation	$\Delta V_O$	$T_J = +25^\circ\text{C}$ $I_O = 5\text{mA}$ to $1.5\text{A}$		12	100	mV
		$I_O = 5\text{mA}$ to $1.0\text{A}$		12	100	
		$I_O = 250$ to $750\text{mA}$		5	50	
Quiescent Current	$I_Q$	$T_J = +25^\circ\text{C}$		5.1	6.0	mA
Quiescent Current Change	$\Delta I_Q$	$V_I = 13.8\text{V}$ to $26\text{V}$ , $T_J = +25^\circ\text{C}$			0.8	mA
		$V_I = 14\text{V}$ to $27\text{V}$ , $I_O = 500\text{mA}$			0.8	
		$I_O = 5\text{mA}$ to $1.0\text{A}$			0.5	
Output Voltage Drift	$\Delta V_O / \Delta T$	$I_O = 5\text{mA}$		-1.0		mV/ $^\circ\text{C}$
Output Noise Voltage	$V_N$	$f = 10\text{Hz}$ to $100\text{KHz}$ $T_A = +25^\circ\text{C}$		10		$\mu\text{V}/V_O$
Ripple Rejection	RR	$f = 120\text{Hz}$ , $I_O = 500\text{mA}$ $V_I = 14\text{V}$ to $24\text{V}$		61		dB
Dropout Voltage	$V_D$	$I_O = 1\text{A}$ , $T_J = +25^\circ\text{C}$		2.0		V
Output Resistance	$R_O$	$f = 1\text{KHz}$		18		$\text{m}\Omega$
Short Circuit Current	$I_{SC}$	$V_I = 35\text{V}$ , $T_A = +25^\circ\text{C}$		250		mA
Peak Current	$I_{PK}$	$T_J = +25^\circ\text{C}$		2.2		A

\* Load and line regulation are specified at constant, junction temperature. Change in  $V_O$  due to heating effects must be taken into account separately. Pulse testing with low duty is used.

## LM78XX (KA78XX, MC78XX) FIXED VOLTAGE REGULATOR (POSITIVE)

### LM7812A/RA ELECTRICAL CHARACTERISTICS

(Refer to the test circuits.  $T_J = 0$  to  $+125^\circ\text{C}$ ,  $I_O = 1\text{A}$ ,  $V_I = 19\text{V}$ ,  $C_I = 0.33\mu\text{F}$ ,  $C_O = 0.1\mu\text{F}$ , unless otherwise specified)

Characteristic	Symbol	Test Conditions	Min	Typ	Max	Unit
Output Voltage	$V_O$	$T_J = +25^\circ\text{C}$	11.75	12	12.25	V
		$I_O = 5\text{mA}$ to $1\text{A}$ , $P_D \leq 15\text{W}$ $V_I = 14.8$ to $27\text{V}$	11.5	12	12.5	
Line Regulation	$\Delta V_O$	$V_I = 14.8$ to $30\text{V}$ $I_O = 500\text{mA}$		10	120	mV
		$V_I = 16$ to $22\text{V}$		4	120	
		$T_J = +25^\circ\text{C}$	$V_I = 14.5\text{V}$ to $27\text{V}$ $V_I = 16\text{V}$ to $22\text{V}$		10 3	
Load Regulation	$\Delta V_O$	$T_J = +25^\circ\text{C}$ $I_O = 5\text{mA}$ to $1.5\text{A}$		12	100	mV
		$I_O = 5\text{mA}$ to $1.0\text{A}$		12	100	
		$I_O = 250$ to $750\text{mA}$		5	50	
Quiescent Current	$I_Q$	$T_J = +25^\circ\text{C}$		5.1	6.0	mA
Quiescent Current Change	$\Delta I_Q$	$V_I = 15\text{V}$ to $30\text{V}$ , $T_J = +25^\circ\text{C}$			0.5	mA
		$V_I = 14\text{V}$ to $27\text{V}$ , $I_O = 500\text{mA}$			0.8	
		$I_O = 5\text{mA}$ to $1.0\text{A}$			0.8	
Output Voltage Drift	$\Delta V_O/\Delta T$	$I_O = 5\text{mA}$		-1.0		mV/ $^\circ\text{C}$
Output Noise Voltage	$V_N$	$f = 10\text{Hz}$ to $100\text{KHz}$ $T_A = +25^\circ\text{C}$		10		$\mu\text{V}/V_O$
Ripple Rejection	RR	$f = 120\text{Hz}$ , $I_O = 500\text{mA}$ $V_I = 14\text{V}$ to $24\text{V}$		60		dB
Dropout Voltage	$V_D$	$I_O = 1\text{A}$ , $T_J = +25^\circ\text{C}$		2.0		V
Output Resistance	$R_O$	$f = 1\text{KHz}$		18		$\text{m}\Omega$
Short Circuit Current	$I_{SC}$	$V_I = 35\text{V}$ , $T_A = +25^\circ\text{C}$		250		mA
Peak Current	$I_{PK}$	$T_J = +25^\circ\text{C}$		2.2		A

\* Load and line regulation are specified at constant, junction temperature. Change in  $V_O$  due to heating effects must be taken into account separately. Pulse testing with low duty is used.

## LM78XX (KA78XX, MC78XX) FIXED VOLTAGE REGULATOR (POSITIVE)

### LM7815A/RA ELECTRICAL CHARACTERISTICS

(Refer to the test circuits.  $T_J = 0$  to  $+150$  °C,  $I_O = 1A$ ,  $V_I = 23V$ ,  $C_1 = 0.33\mu F$ ,  $C_O = 0.1\mu F$ , unless otherwise specified)

Characteristic	Symbol	Test Conditions	Min	Typ	Max	Unit
Output Voltage	$V_O$	$T_J = +25$ °C	14.7	15	15.3	V
		$I_O = 5mA$ to $1A$ , $P_D \leq 15W$ $V_I = 17.7$ to $30V$	14.4	15	15.6	
Line Regulation	$\Delta V_O$	$V_I = 17.9$ to $30V$ $I_O = 500mA$		10	150	mV
		$V_I = 20$ to $26V$		5	150	
		$T_J = +25$ °C	$V_I = 17.5V$ to $30V$ $V_I = 20V$ to $26V$		11 3	
Load Regulation	$\Delta V_O$	$T_J = +25$ °C $I_O = 5mA$ to $1.5A$		12	100	mV
		$I_O = 5mA$ to $1.0A$		12	100	
		$I_O = 250$ to $750mA$		5	50	
Quiescent Current	$I_Q$	$T_J = +25$ °C		5.2	6.0	mA
Quiescent Current Change	$\Delta I_Q$	$V_I = 17.5V$ to $30V$ , $T_J = +25$ °C			0.5	mA
		$V_I = 17.5V$ to $30V$ , $I_O = 500mA$			0.8	
		$I_O = 5mA$ to $1.0A$			0.8	
Output Voltage Drift	$\Delta V_O / \Delta T$	$I_O = 5mA$		-1.0		mV/°C
Output Noise Voltage	$V_N$	$f = 10Hz$ to $100KHz$ $T_A = +25$ °C		10		$\mu V / V_O$
Ripple Rejection	RR	$f = 120Hz$ , $I_O = 500mA$ $V_I = 18.5V$ to $28.5V$		58		dB
Dropout Voltage	$V_D$	$I_O = 1A$ , $T_J = +25$ °C		2.0		V
Output Resistance	$R_O$	$f = 1KHz$		19		m $\Omega$
Short Circuit Current	$I_{SC}$	$V_I = 35V$ , $T_A = +25$ °C		250		mA
Peak Current	$I_{PK}$	$T_J = +25$ °C		2.2		A

\* Load and line regulation are specified at constant, junction temperature. Change in  $V_O$  due to heating effects must be taken into account separately. Pulse testing with low duty is used.

## LM78XX (KA78XX, MC78XX) FIXED VOLTAGE REGULATOR (POSITIVE)

### LM7818A/RA ELECTRICAL CHARACTERISTICS

(Refer to the test circuits.  $T_J = 0$  to  $+150^\circ\text{C}$ ,  $I_O = 1\text{A}$ ,  $V_I = 27\text{V}$ ,  $C_I = 0.33\mu\text{F}$ ,  $C_O = 0.1\mu\text{F}$ , unless otherwise specified)

Characteristic	Symbol	Test Conditions	Min	Typ	Max	Unit
Output Voltage	$V_O$	$T_J = +25^\circ\text{C}$	17.64	18	18.36	V
		$I_O = 5\text{mA}$ to $1\text{A}$ , $P_D \leq 15\text{W}$ $V_I = 21$ to $33\text{V}$	17.3	18	18.7	
Line Regulation	$\Delta V_O$	$V_I = 21$ to $33\text{V}$ $I_O = 500\text{mA}$		15	180	mV
		$V_I = 21$ to $33\text{V}$		5	180	
		$T_J = +25^\circ\text{C}$ $V_I = 20.6\text{V}$ to $33\text{V}$		15	180	
		$V_I = 24\text{V}$ to $30\text{V}$		5	90	
Load Regulation	$\Delta V_O$	$T_J = +25^\circ\text{C}$ $I_O = 5\text{mA}$ to $1.5\text{A}$		15	100	mV
		$I_O = 5\text{mA}$ to $1.0\text{A}$		15	100	
		$I_O = 250$ to $750\text{mA}$		7	50	
Quiescent Current	$I_Q$	$T_J = +25^\circ\text{C}$		5.2	6.0	mA
Quiescent Current Change	$\Delta I_Q$	$V_I = 21\text{V}$ to $33\text{V}$ , $T_J = +25^\circ\text{C}$			0.5	mA
		$V_I = 21\text{V}$ to $33\text{V}$ , $I_O = 500\text{mA}$			0.8	
		$I_O = 5\text{mA}$ to $1.0\text{A}$			0.8	
Output Voltage Drift	$\Delta V_O / \Delta T$	$I_O = 5\text{mA}$		-1.0		mV/ $^\circ\text{C}$
Output Noise Voltage	$V_N$	$f = 10\text{Hz}$ to $100\text{KHz}$ $T_A = +25^\circ\text{C}$		10		$\mu\text{V}/V_O$
Ripple Rejection	RR	$f = 120\text{Hz}$ , $I_O = 500\text{mA}$ $V_I = 18.5\text{V}$ to $28.5\text{V}$		57		dB
Dropout Voltage	$V_D$	$I_O = 1\text{A}$ , $T_J = +25^\circ\text{C}$		2.0		V
Output Resistance	$R_O$	$f = 1\text{KHz}$		19		$\text{m}\Omega$
Short Circuit Current	$I_{SC}$	$V_I = 35\text{V}$ , $T_A = +25^\circ\text{C}$		250		mA
Peak Current	$I_{PK}$	$T_J = +25^\circ\text{C}$		2.2		A

\* Load and line regulation are specified at constant, junction temperature. Change in  $V_O$  due to heating effects must be taken into account separately. Pulse testing with low duty is used.

## LM78XX (KA78XX, MC78XX) FIXED VOLTAGE REGULATOR (POSITIVE)

### LM7824A/RA ELECTRICAL CHARACTERISTICS

(Refer to the test circuits.  $T_J = 0$  to  $+150^\circ\text{C}$ ,  $I_O = 1\text{A}$ ,  $V_I = 33\text{V}$ ,  $C_I = 0.33\mu\text{F}$ ,  $C_O = 0.1\mu\text{F}$ , unless otherwise specified)

Characteristic	Symbol	Test Conditions	Min	Typ	Max	Unit
Output Voltage	$V_O$	$T_J = +25^\circ\text{C}$	23.5	24	24.5	V
		$I_O = 5\text{mA}$ to $1\text{A}$ , $P_D \leq 15\text{W}$ $V_I = 27.3$ to $38\text{V}$	23	24	25	
Line Regulation	$\Delta V_O$	$V_I = 27$ to $38\text{V}$ $I_O = 500\text{mA}$		18	240	mV
		$V_I = 21$ to $33\text{V}$		6	240	
		$T_J = +25^\circ\text{C}$	$V_I = 26.7\text{V}$ to $38\text{V}$ $V_I = 30\text{V}$ to $36\text{V}$		18	
Load Regulation	$\Delta V_O$	$T_J = +25^\circ\text{C}$ $I_O = 5\text{mA}$ to $1.5\text{A}$		15	100	mV
		$I_O = 5\text{mA}$ to $1.0\text{A}$		15	100	
		$I_O = 250$ to $750\text{mA}$		7	50	
Quiescent Current	$I_Q$	$T_J = +25^\circ\text{C}$		5.2	6.0	mA
Quiescent Current Change	$\Delta I_Q$	$V_I = 27.3\text{V}$ to $38\text{V}$ , $T_J = +25^\circ\text{C}$			0.5	mA
		$V_I = 27.3\text{V}$ to $38\text{V}$ , $I_O = 500\text{mA}$			0.8	
		$I_O = 5\text{mA}$ to $1.0\text{A}$			0.8	
Output Voltage Drift	$\Delta V_O/\Delta T$	$I_O = 5\text{mA}$		-1.5		mV/ $^\circ\text{C}$
Output Noise Voltage	$V_N$	$f = 10\text{Hz}$ to $100\text{KHz}$ $T_A = 25^\circ\text{C}$		10		$\mu\text{V}/V_O$
Ripple Rejection	RR	$f = 120\text{Hz}$ , $I_O = 500\text{mA}$ $V_I = 18.5\text{V}$ to $28.5\text{V}$		54		dB
Dropout Voltage	$V_D$	$I_O = 1\text{A}$ , $T_J = +25^\circ\text{C}$		2.0		V
Output Resistance	$R_O$	$f = 1\text{KHz}$		20		$\text{m}\Omega$
Short Circuit Current	$I_{SC}$	$V_I = 35\text{V}$ , $T_A = +25^\circ\text{C}$		250		mA
Peak Current	$I_{PK}$	$T_J = +25^\circ\text{C}$		2.2		A

\* Load and line regulation are specified at constant, junction temperature. Change in  $V_O$  due to heating effects must be taken into account separately. Pulse testing with low duty is used.

# LM78XX (KA78XX, MC78XX) FIXED VOLTAGE REGULATOR (POSITIVE)

## TYPICAL PERFORMANCE CHARACTERISTICS

Fig. 1 Quiescent Current

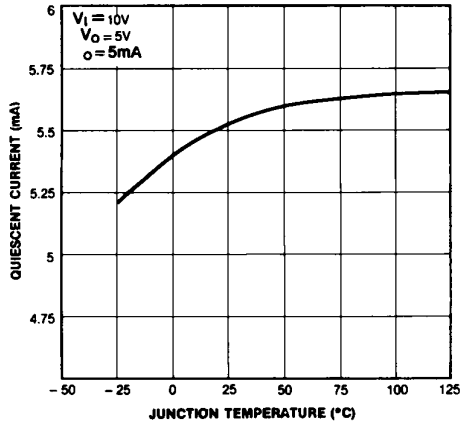

Fig. 2 Peak Output Current

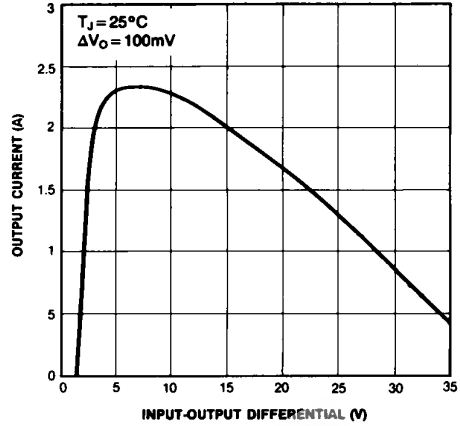

Fig. 3 Output Voltage

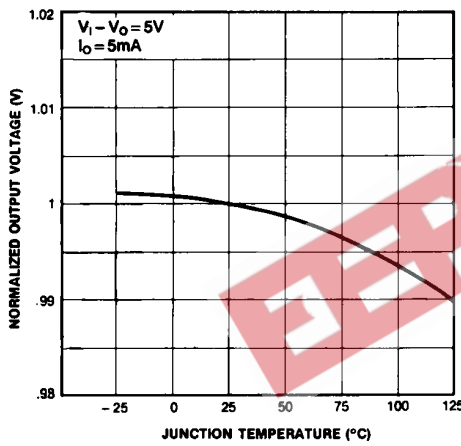
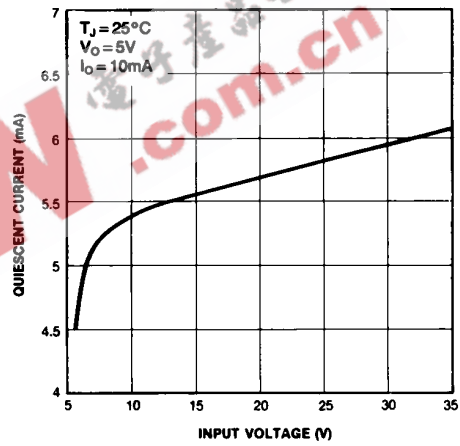

Fig. 4 Quiescent Current



# LM78XX (KA78XX, MC78XX) FIXED VOLTAGE REGULATOR (POSITIVE)

## TYPICAL APPLICATIONS

Fig. 5 DC Parameters

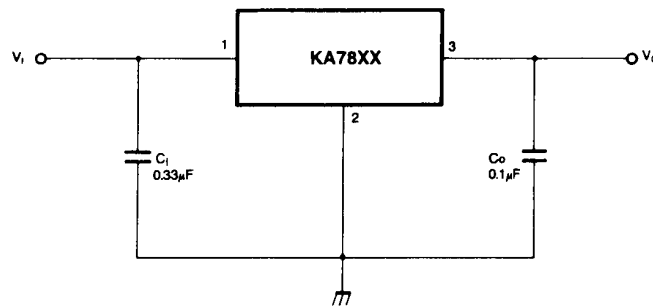

Fig. 6 Load Regulation

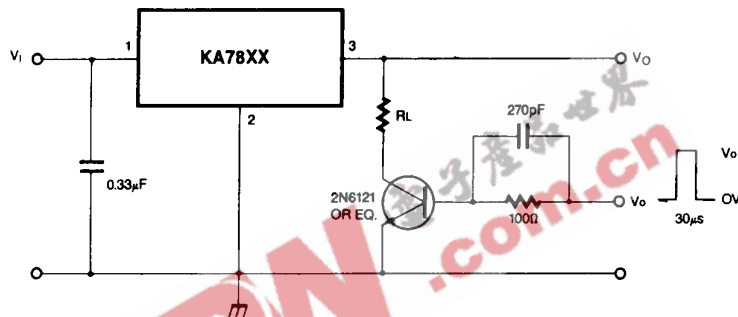
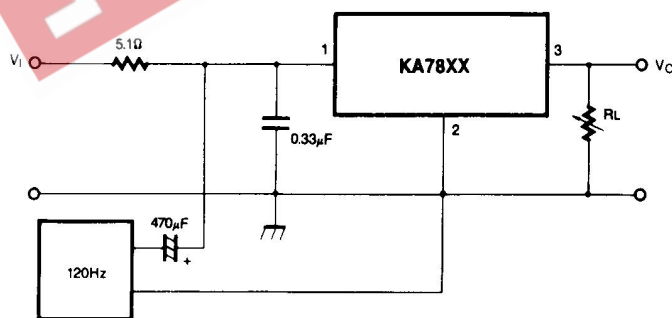

Fig. 7 Ripple Rejection



**FAIRCHILD**  
SEMICONDUCTOR™

## LM78XX (KA78XX, MC78XX) FIXED VOLTAGE REGULATOR (POSITIVE)

Fig. 8 Fixed Output Regulator

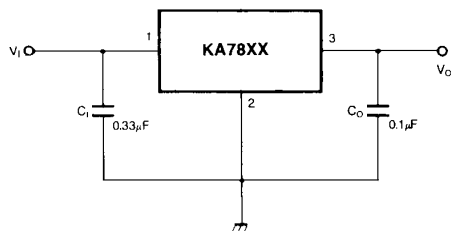
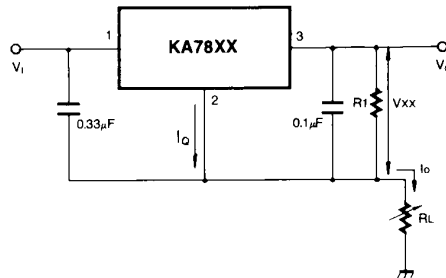

Fig. 9 Constant Current Regulator



$$I_o = \frac{V_{XX}}{R_1} + I_Q$$

**Notes:**

- (1) To specify an output voltage, substitute voltage value for "XX."  
A common ground is required between the input and the Output voltage. The input voltage must remain typically 2.0V above the output voltage even during the low point on the input ripple voltage.
- (2)  $C_1$  is required if regulator is located an appreciable distance from power Supply filter.
- (3)  $C_o$  improves stability and transient response.

Fig. 10 Circuit for Increasing Output Voltage

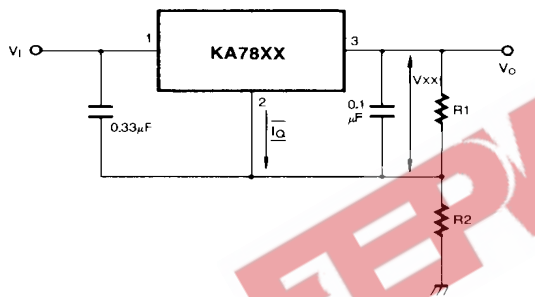
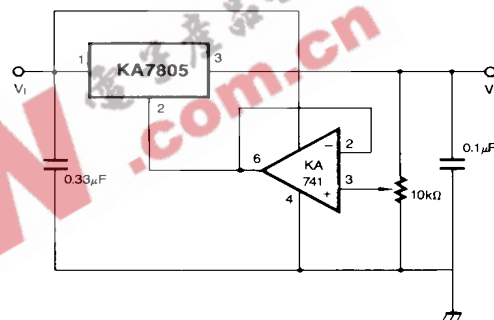

Fig. 11 Adjustable Output Regulator (7 to 30V)



$$I_{R1} \geq 5 I_Q$$

$$V_o = V_{XX} (1 + R_2/R_1) + I_Q R_2$$



# LM78XX (KA78XX, MC78XX) FIXED VOLTAGE REGULATOR (POSITIVE)

## TYPICAL APPLICATIONS (Continued)

Fig. 12 High Current Voltage Regulator

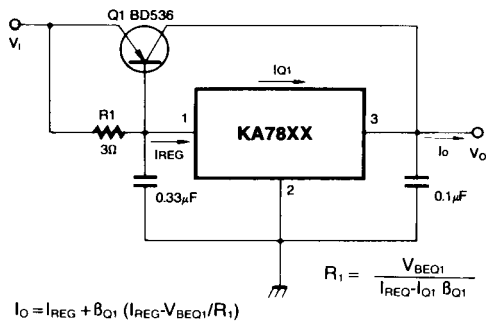

Fig. 13 High Output Current with Short Circuit Protection

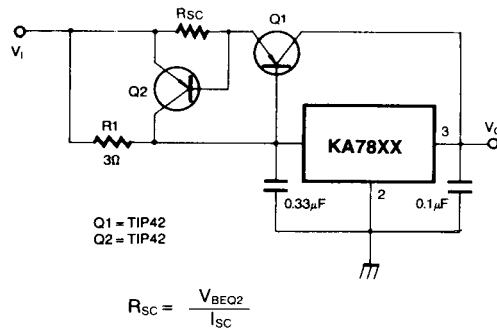

Fig. 14 Tracking Voltage Regulator

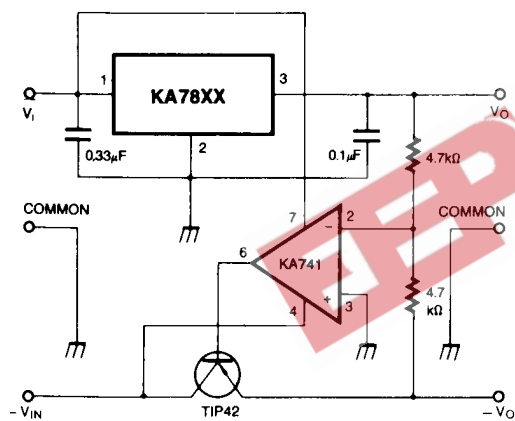
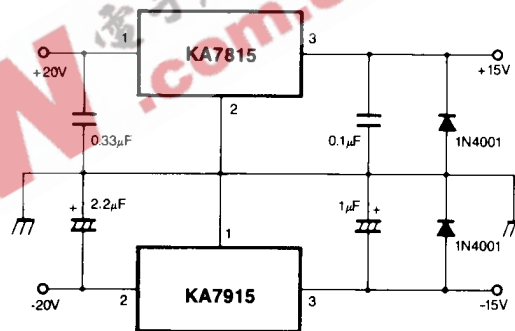

Fig. 15 Split Power Supply ( $\pm 15V-1A$ )



## LM78XX (KA78XX, MC78XX) FIXED VOLTAGE REGULATOR (POSITIVE)

### TYPICAL APPLICATIONS (Continued)

Fig. 16 Negative Output Voltage Circuit

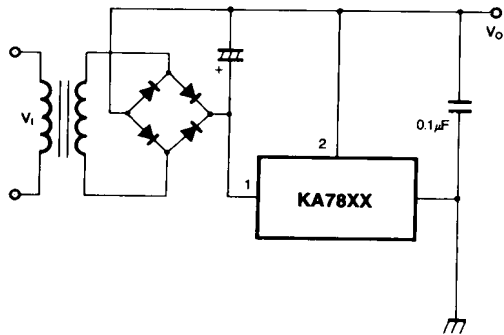
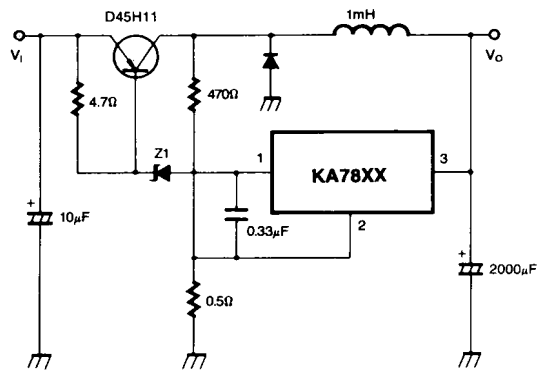

Fig. 17 switching Regulator



EEPW 电子产品世界 .com.cn

**LM78XX (KA78XX, MC78XX) FIXED VOLTAGE REGULATOR (POSITIVE)**

---

EEPW 电子產品世界 .com.cn

## TRADEMARKS

The following are registered and unregistered trademarks Fairchild Semiconductor owns or is authorized to use and is not intended to be an exhaustive list of all such trademarks.

ACEx™	ISOPLANAR™
CoolFET™	MICROWIRE™
CROSSVOLT™	POP™
E <sup>2</sup> CMOS™	PowerTrench™
FACT™	QS™
FACT Quiet Series™	Quiet Series™
FAST®	SuperSOT™-3
FASTr™	SuperSOT™-6
GTO™	SuperSOT™-8
HiSeC™	TinyLogic™

## DISCLAIMER

FAIRCHILD SEMICONDUCTOR RESERVES THE RIGHT TO MAKE CHANGES WITHOUT FURTHER NOTICE TO ANY PRODUCTS HEREIN TO IMPROVE RELIABILITY, FUNCTION OR DESIGN. FAIRCHILD DOES NOT ASSUME ANY LIABILITY ARISING OUT OF THE APPLICATION OR USE OF ANY PRODUCT OR CIRCUIT DESCRIBED HEREIN; NEITHER DOES IT CONVEY ANY LICENSE UNDER ITS PATENT RIGHTS, NOR THE RIGHTS OF OTHERS.

## LIFE SUPPORT POLICY

FAIRCHILD'S PRODUCTS ARE NOT AUTHORIZED FOR USE AS CRITICAL COMPONENTS IN LIFE SUPPORT DEVICES OR SYSTEMS WITHOUT THE EXPRESS WRITTEN APPROVAL OF FAIRCHILD SEMICONDUCTOR CORPORATION. As used herein:

1. Life support devices or systems are devices or systems which, (a) are intended for surgical implant into the body, or (b) support or sustain life, or (c) whose failure to perform when properly used in accordance with instructions for use provided in the labeling, can be reasonably expected to result in significant injury to the user.
2. A critical component is any component of a life support device or system whose failure to perform can be reasonably expected to cause the failure of the life support device or system, or to affect its safety or effectiveness.

## PRODUCT STATUS DEFINITIONS

### Definition of Terms

Datasheet Identification	Product Status	Definition
Advance Information	Formative or In Design	This datasheet contains the design specifications for product development. Specifications may change in any manner without notice.
Preliminary	First Production	This datasheet contains preliminary data, and supplementary data will be published at a later date. Fairchild Semiconductor reserves the right to make changes at any time without notice in order to improve design.
No Identification Needed	Full Production	This datasheet contains final specifications. Fairchild Semiconductor reserves the right to make changes at any time without notice in order to improve design.
Obsolete	Not In Production	This datasheet contains specifications on a product that has been discontinued by Fairchild semiconductor. The datasheet is printed for reference information only.