

MC74AC646, MC74ACT646

Octal Transceiver/Register with 3-State Outputs (Non-inverting)

The MC74AC646/74ACT646 consist of registered bus transceiver circuits, with outputs, D-type flip-flops and control circuitry providing multiplexed transmission of data directly from the input bus or from the internal storage registers. Data on the A or B bus will be loaded into the respective registers on the LOW-to-HIGH transition of the appropriate clock pin (CAB or CBA). The four fundamental data handling functions available are illustrated Figures 1 to 4.

- Independent Registers for A and B Buses
- Multiplexed Real-Time and Stored Data Transfers
- Choice of True and Inverting Data Paths
- 3-State Outputs
- 300 mil Slim Dual In-Line Package
- Outputs Source/Sink 24 mA
- 'ACT646 Has TTL Compatible Inputs

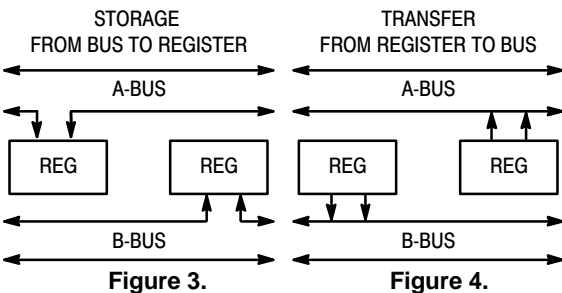
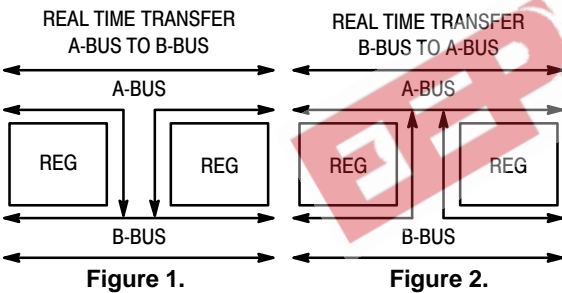

ON Semiconductor™

<http://onsemi.com>

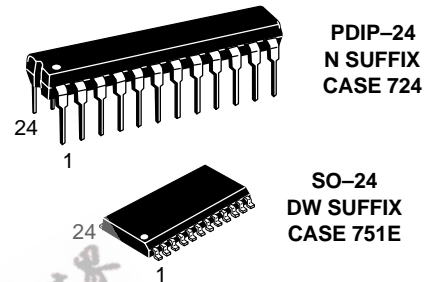

MARKING DIAGRAMS

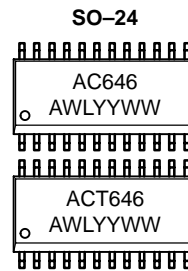
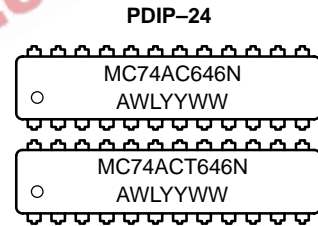

A = Assembly Location
L, WL = Wafer Lot
Y, YY = Year
W, WW = Work Week

ORDERING INFORMATION

Device	Package	Shipping
MC74AC646N	PDIP-24	15 Units/Rail
MC74ACT646N	PDIP-24	15 Units/Rail
MC74AC646DW	SOIC-24	30 Units/Rail
MC74AC646DWR2	SOIC-24	1000 Tape & Reel
MC74ACT646DW	SOIC-24	30 Units/Rail
MC74ACT646DWR2	SOIC-24	1000 Tape & Reel

MC74AC646, MC74ACT646

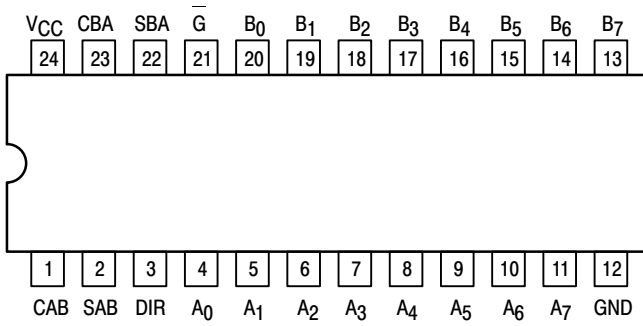

PIN ASSIGNMENT

PIN	FUNCTION
A ₀ –A ₇	Data Register Inputs Data Register A Outputs
B ₀ –B ₇	Data Register B Inputs Data Register B Outputs
CAB, CBA	Clock Pulse Inputs
SAB, SBA	Transmit/Receive Inputs
DIR, G	Output Enable Inputs

Figure 5. Pinout: 24–Lead Packages Conductors
(Top View)

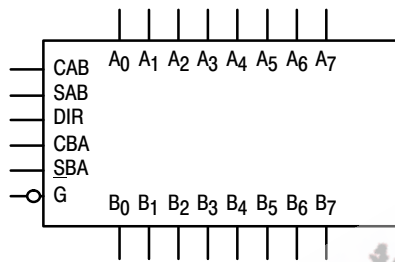
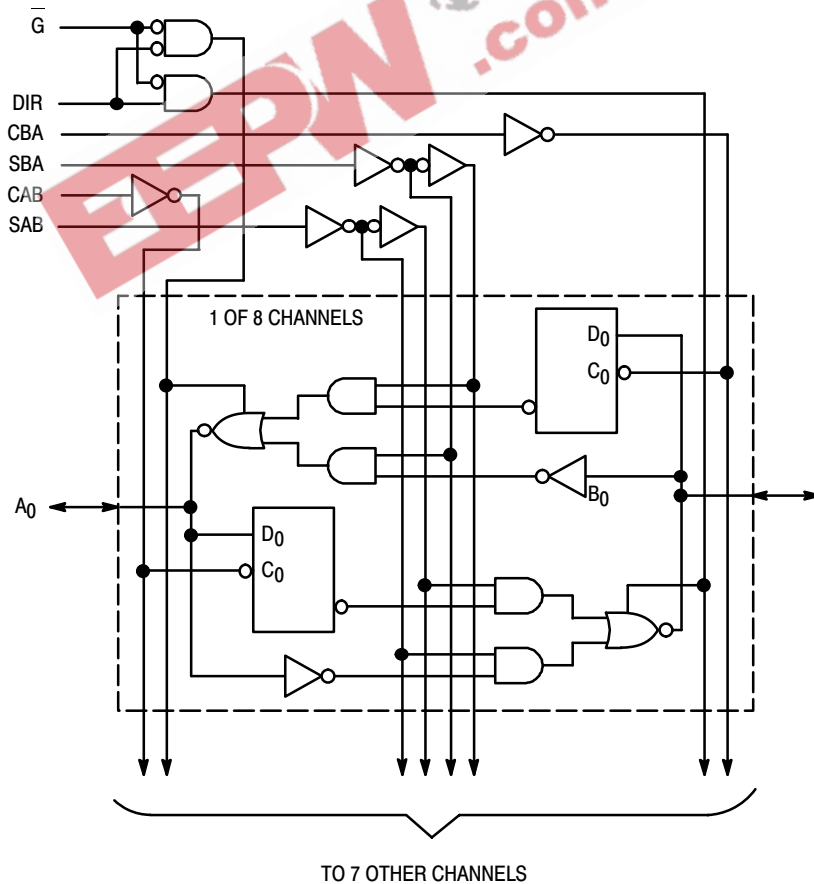

Figure 6. Logic Symbol



NOTE: This diagram is provided only for the understanding of logic operations and should not be used to estimate propagation delays.

Figure 7. Logic Diagram

MC74AC646, MC74ACT646

FUNCTION TABLE

Inputs						Data I/O*		Operation or Function
G	DIR	CAB	CBA	SAB	SBA	A ₀ –A ₇	B ₀ –B ₇	
H	X	H or L	H or L	X	X	Input	Input	Isolation Store A and B Data
H	X	┐	┐	X	X			
L	L	X	X	X	L	Output	Input	Real Time B Data to A Bus Stored B Data to A Bus
L	L	X	X	X	H			
L	H	X	X	L	X	Input	Output	Real Time A Data to B Bus Stored A Data to B Bus
L	H	H or L	X	H	X			

*The data output functions may be enabled or disabled by various signals at the G and DIR inputs. Data input functions are always enabled; i.e., data at the bus pins will be stored on every LOW-to-HIGH transition of the appropriate clock inputs.

NOTE: H = HIGH Voltage Level; L = LOW Voltage Level; X = Immaterial; ┐ = LOW-to-HIGH Transition

MAXIMUM RATINGS*

Symbol	Parameter	Value	Unit
V _{CC}	DC Supply Voltage (Referenced to GND)	–0.5 to +7.0	V
V _{in}	DC Input Voltage (Referenced to GND)	–0.5 to V _{CC} +0.5	V
V _{out}	DC Output Voltage (Referenced to GND)	–0.5 to V _{CC} +0.5	V
I _{in}	DC Input Current, per Pin	±20	mA
I _{out}	DC Output Sink/Source Current, per Pin	±50	mA
I _{CC}	DC V _{CC} or GND Current per Output Pin	±50	mA
T _{stg}	Storage Temperature	–65 to +150	°C

*Maximum Ratings are those values beyond which damage to the device may occur. Functional operation should be restricted to the Recommended Operating Conditions.

RECOMMENDED OPERATING CONDITIONS

Symbol	Parameter	Min	Typ	Max	Unit	
V _{CC}	Supply Voltage	'AC	2.0	5.0	6.0	V
		'ACT	4.5	5.0	5.5	
V _{in} , V _{out}	DC Input Voltage, Output Voltage (Ref. to GND)	0	–	V _{CC}	V	
t _r , t _f	Input Rise and Fall Time (Note 1) 'AC Devices except Schmitt Inputs	V _{CC} @ 3.0 V	–	150	–	ns/V
		V _{CC} @ 4.5 V	–	40	–	
		V _{CC} @ 5.5 V	–	25	–	
t _r , t _f	Input Rise and Fall Time (Note 2) 'ACT Devices except Schmitt Inputs	V _{CC} @ 4.5 V	–	10	–	ns/V
		V _{CC} @ 5.5 V	–	8.0	–	
T _J	Junction Temperature (PDIP)	–	–	140	°C	
T _A	Operating Ambient Temperature Range	–40	25	85	°C	
I _{OH}	Output Current – High	–	–	–24	mA	
I _{OL}	Output Current – Low	–	–	24	mA	

1. V_{in} from 30% to 70% V_{CC}; see individual Data Sheets for devices that differ from the typical input rise and fall times.

2. V_{in} from 0.8 V to 2.0 V; see individual Data Sheets for devices that differ from the typical input rise and fall times.

MC74AC646, MC74ACT646

DC CHARACTERISTICS

Symbol	Parameter	V _{CC} (V)	74AC		74ACT		Unit	Conditions
			T _A = +25°C		T _A = -40°C to +85°C			
			Typ	Guaranteed Limits				
V _{IH}	Minimum High Level Input Voltage	3.0	1.5	2.1	2.1		V	V _{OUT} = 0.1 V or V _{CC} - 0.1 V
		4.5	2.25	3.15	3.15			
		5.5	2.75	3.85	3.85			
V _{IL}	Maximum Low Level Input Voltage	3.0	1.5	0.9	0.9		V	V _{OUT} = 0.1 V or V _{CC} - 0.1 V
		4.5	2.25	1.35	1.35			
		5.5	2.75	1.65	1.65			
V _{OH}	Minimum High Level Output Voltage	3.0	2.99	2.9	2.9		V	I _{OUT} = -50 μA
		4.5	4.49	4.4	4.4			
		5.5	5.49	5.4	5.4			
		3.0	-	2.56	2.46		V	*V _{IN} = V _{IL} or V _{IH} -12 mA I _{OH} -24 mA -24 mA
		4.5	-	3.86	3.76			
		5.5	-	4.86	4.76			
V _{OL}	Maximum Low Level Output Voltage	3.0	0.002	0.1	0.1		V	I _{OUT} = 50 μA
		4.5	0.001	0.1	0.1			
		5.5	0.001	0.1	0.1			
		3.0	-	0.36	0.44		V	*V _{IN} = V _{IL} or V _{IH} 12 mA I _{OL} 24 mA 24 mA
		4.5	-	0.36	0.44			
		5.5	-	0.36	0.44			
I _{IN}	Maximum Input Leakage Current	5.5	-	±0.1	±1.0		μA	V _I = V _{CC} , GND
I _{OZT}	Maximum 3-State Current	5.5	-	±0.6	±6.0		μA	V _I (OE) = V _{IL} , V _{IH} V _I = V _{CC} , GND V _O = V _{CC} , GND
I _{OLD}	†Minimum Dynamic Output Current	5.5	-	-	75		mA	V _{OLD} = 1.65 V Max
I _{OHD}		5.5	-	-	-75		mA	V _{OHD} = 3.85 V Min
I _{CC}	Maximum Quiescent Supply Current	5.5	-	8.0	80		μA	V _{IN} = V _{CC} or GND

*All outputs loaded; thresholds on input associated with output under test.

†Maximum test duration 2.0 ms, one output loaded at a time.

NOTE: I_{IN} and I_{CC} @ 3.0 V are guaranteed to be less than or equal to the respective limit @ 5.5 V V_{CC}.

MC74AC646, MC74ACT646

AC CHARACTERISTICS (For Figures and Waveforms – See Section 3 of the ON Semiconductor FACT Data Book, DL138/D)

Symbol	Parameter	V _{CC} * (V)	74AC			74AC		Unit	Fig. No.
			T _A = +25°C C _L = 50 pF			T _A = -40°C to +85°C C _L = 50 pF			
			Min	Typ	Max	Min	Max		
t _{PLH}	Propagation Delay Clock to Bus	3.3 5.0	4.0 2.5	10.5 7.5	16.5 12	3.0 2.0	18.5 13	ns	3-6
t _{PHL}	Propagation Delay Clock to Bus	3.3 5.0	3.0 2.0	9.5 6.5	14.5 10.5	2.5 1.5	16 11.5	ns	3-6
t _{PLH}	Propagation Delay Bus to Bus	3.3 5.0	2.5 1.5	7.5 5.0	12 8.0	2.0 1.0	13.5 9.0	ns	3-5
t _{PHL}	Propagation Delay Bus to Bus	3.3 5.0	1.5 1.5	7.5 5.0	12.5 9.0	1.5 1.0	13.5 9.5	ns	3-5
t _{PLH}	Propagation Delay SBA or SAB to A _n or B _n (w/A _n or B _n HIGH or LOW)	3.3 5.0	2.0 1.5	8.5 6.0	13.5 10	1.5 1.5	15.5 11	ns	3-6
t _{PHL}	Propagation Delay SBA or SAB to A _n or B _n (w/A _n or B _n HIGH or LOW)	3.3 5.0	1.5 1.5	8.5 6.0	13.5 10	1.5 1.5	15 11	ns	3-6
t _{PZH}	Enable Time G to A _n or B _n	3.3 5.0	2.5 1.5	7.0 5.0	11.5 8.5	2.0 1.5	12.5 9.0	ns	3-7
t _{PZL}	Enable Time G to A _n or B _n	3.3 5.0	2.5 1.5	7.5 5.5	12.5 9.0	2.0 1.5	14 10	ns	3-8
t _{PHZ}	Disable Time G to A _n or B _n	3.3 5.0	3.0 2.0	8.0 6.5	12.5 10	2.5 2.0	13.5 11	ns	3-7
t _{PLZ}	Disable Time G to A _n or B _n	3.3 5.0	2.0 1.5	7.5 6.0	12 9.5	2.0 1.5	13.5 10.5	ns	3-8
t _{PZH}	Enable Time DIR to A _n or B _n	3.3 5.0	2.0 1.5	6.5 5.0	11 7.5	1.5 1.0	12 8.5	ns	3-7
t _{PZL}	Enable Time DIR to A _n or B _n	3.3 5.0	2.5 1.5	7.0 5.0	11.5 8.0	2.0 1.0	13 9.0	ns	3-8
t _{PHZ}	Disable Time DIR to A _n or B _n	3.3 5.0	2.5 1.5	7.5 5.5	11.5 9.5	1.5 1.5	12.5 10	ns	3-7
t _{PLZ}	Disable Time DIR to A _n or B _n	3.3 5.0	1.5 1.5	7.5 5.5	12 9.5	1.5 1.5	13.5 10.5	ns	3-8

*Voltage Range 3.3 V is 3.3 V ±0.3 V.
Voltage Range 5.0 V is 5.0 V ±0.5 V.

MC74AC646, MC74ACT646

AC OPERATING REQUIREMENTS

Symbol	Parameter	V _{CC} * (V)	74AC		74AC		Unit	Fig. No.
			T _A = +25°C C _L = 50 pF		T _A = -40°C to +85°C C _L = 50 pF			
			Typ	Guaranteed Minimum				
t _s	Setup Time, HIGH or LOW Bus to Clock	3.3	2.0	5.0	5.5	ns	3-9	
		5.0	1.5	4.0	4.5			
t _h	Hold Time, HIGH or LOW Bus to Clock	3.3	-1.5	0	0	ns	3-9	
		5.0	-0.5	0.5	1.0			
t _w	Clock Pulse Width HIGH or LOW	3.3	2.0	3.5	4.5	ns	3-6	
		5.0	2.0	3.5	3.5			

*Voltage Range 3.3 V is 3.3 V ±0.3 V.
Voltage Range 5.0 V is 5.0 V ±0.5 V.

DC CHARACTERISTICS

Symbol	Parameter	V _{CC} (V)	74ACT		74ACT		Unit	Conditions
			T _A = +25°C		T _A = -40°C to +85°C			
			Typ	Guaranteed Limits				
V _{IH}	Minimum High Level Input Voltage	4.5	1.5	2.0	2.0	V	V _{OUT} = 0.1 V or V _{CC} - 0.1 V	
		5.5	1.5	2.0	2.0			
V _{IL}	Maximum Low Level Input Voltage	4.5	1.5	0.8	0.8	V	V _{OUT} = 0.1 V or V _{CC} - 0.1 V	
		5.5	1.5	0.8	0.8			
V _{OH}	Minimum High Level Output Voltage	4.5	4.49	4.4	4.4	V	I _{OUT} = -50 μA	
		5.5	5.49	5.4	5.4			
		4.5	-	3.86	3.76	V	*V _{IN} = V _{IL} or V _{IH} -24 mA I _{OH} -24 mA	
		5.5	-	4.86	4.76			
V _{OL}	Maximum Low Level Output Voltage	4.5	0.001	0.1	0.1	V	I _{OUT} = 50 μA	
		5.5	0.001	0.1	0.1			
		4.5	-	0.36	0.44	V	*V _{IN} = V _{IL} or V _{IH} 24 mA I _{OL} 24 mA	
		5.5	-	0.36	0.44			
I _{IN}	Maximum Input Leakage Current	5.5	-	±0.1	±1.0	μA	V _I = V _{CC} , GND	
ΔI _{CC} T	Additional Max. I _{CC} /Input	5.5	0.6	-	1.5	mA	V _I = V _{CC} - 2.1 V	
I _{OZT}	Maximum 3-State Current	5.5	-	±0.6	±6.0	μA	V _I (OE) = V _{IL} , V _{IH} V _I = V _{CC} , GND V _O = V _{CC} , GND	
I _{OLD}	†Minimum Dynamic Output Current	5.5	-	-	75	mA	V _{OLD} = 1.65 V Max	
I _{OHD}		5.5	-	-	-75	mA	V _{OHD} = 3.85 V Min	
I _{CC}	Maximum Quiescent Supply Current	5.5	-	8.0	80	μA	V _{IN} = V _{CC} or GND	

*All outputs loaded; thresholds on input associated with output under test.

†Maximum test duration 2.0 ms, one output loaded at a time.

MC74AC646, MC74ACT646

AC CHARACTERISTICS (For Figures and Waveforms – See Section 3 of the ON Semiconductor FACT Data Book, DL138/D)

Symbol	Parameter	V _{CC} * (V)	74ACT			74ACT		Unit	Fig. No.
			T _A = +25°C C _L = 50 pF			T _A = -40°C to +85°C C _L = 50 pF			
			Min	Typ	Max	Min	Max		
t _{PLH}	Propagation Delay Clock to Bus	5.0	3.5	12.0	14.5	3.0	16.0	ns	3-6
t _{PHL}	Propagation Delay Clock to Bus	5.0	4.0	12.0	14.5	3.5	16.0	ns	3-6
t _{PLH}	Propagation Delay Bus to Bus	5.0	3.0	8.5	11.0	2.5	12.0	ns	3-5
t _{PHL}	Propagation Delay Bus to Bus	5.0	2.5	8.5	11.0	2.0	12.0	ns	3-5
t _{PLH}	Propagation Delay SBA or SAB to A _n or B _n (w/A _n or B _n HIGH or LOW)	5.0	3.0	9.5	12.0	2.5	13.0	ns	3-6
t _{PHL}	Propagation Delay SBA or SAB to A _n or B _n (w/A _n or B _n HIGH or LOW)	5.0	3.0	9.5	12.0	2.5	13.0	ns	3-6
t _{PZH}	Enable Time G to A _n or B _n	5.0	2.0	9.0	11.0	1.5	12.0	ns	3-7
t _{PZL}	Enable Time G to A _n or B _n	5.0	3.5	9.0	11.0	3.0	12.0	ns	3-8
t _{PHZ}	Disable Time G to A _n or B _n	5.0	5.0	10.5	13.0	4.5	14.5	ns	3-7
t _{PLZ}	Disable Time G to A _n or B _n	5.0	3.5	10.0	12.5	3.0	14.0	ns	3-8
t _{PZH}	Enable Time DIR to A _n or B _n	5.0	2.0	6.5	12.5	1.5	13.5	ns	3-7
t _{PZL}	Enable Time DIR to A _n or B _n	5.0	3.5	6.5	12.5	3.0	13.5	ns	3-8
t _{PHZ}	Disable Time DIR to A _n or B _n	5.0	5.0	8.5	12.5	4.5	13.5	ns	3-7
t _{PLZ}	Disable Time DIR to A _n or B _n	5.0	3.5	8.5	12.5	3.0	13.5	ns	3-8

*Voltage Range 5.0 V is 5.0 V ±0.5 V.

MC74AC646, MC74ACT646

AC OPERATING REQUIREMENTS

Symbol	Parameter	V _{CC} * (V)	74ACT		Unit	Fig. No.	
			T _A = +25°C C _L = 50 pF				T _A = -40°C to +85°C C _L = 50 pF
			Typ	Guaranteed Minimum			
t _s	Setup Time, HIGH or LOW Bus to Clock	5.0	–	7.0	8.0	ns	3–9
t _h	Hold Time, HIGH or LOW Bus to Clock	5.0	–	2.5	2.5	ns	3–9
t _w	Clock Pulse Width HIGH or LOW	5.0	–	7.0	8.0	ns	3–6

*Voltage Range 5.0 V is 5.0 V ±0.5 V.

CAPACITANCE

Symbol	Parameter	Value Typ	Unit	Test Conditions
C _{IN}	Input Capacitance	4.5	pF	V _{CC} = 5.0 V
C _{I/O}	Input/Output Capacitance	15	pF	V _{CC} = 5.0 V
C _{PD}	Power Dissipation Capacitance	60	pF	V _{CC} = 5.0 V

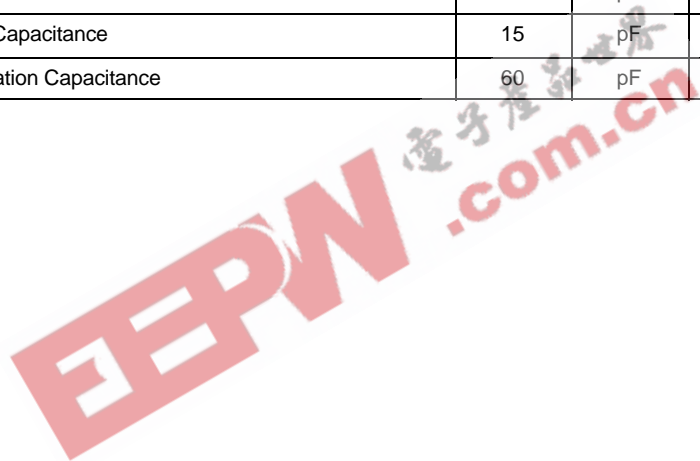

MC74AC646, MC74ACT646

PACKAGE DIMENSIONS

PDIP-24
N SUFFIX
 24 PIN PLASTIC DIP PACKAGE
 CASE 724-03
 ISSUE D

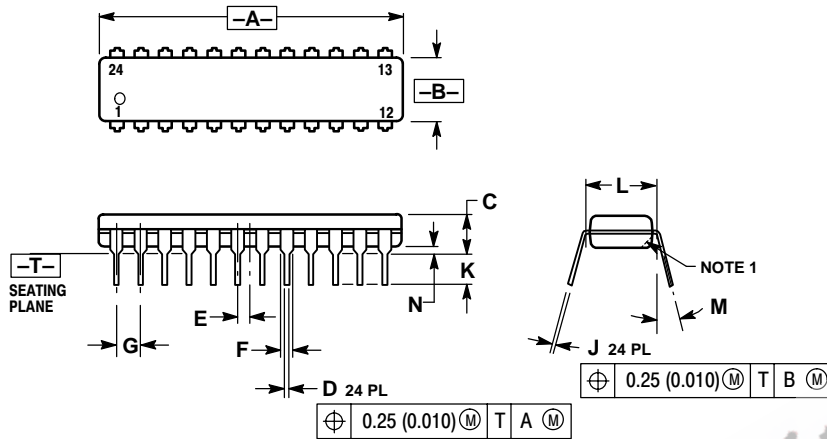

- NOTES:
1. CHAMFERED CONTOUR OPTIONAL.
 2. DIMENSION L TO CENTER OF LEADS WHEN FORMED PARALLEL.
 3. DIMENSIONING AND TOLERANCING PER ANSI Y14.5M, 1982.
 4. CONTROLLING DIMENSION: INCH.

DIM	INCHES		MILLIMETERS	
	MIN	MAX	MIN	MAX
A	1.230	1.265	31.25	32.13
B	0.250	0.270	6.35	6.85
C	0.145	0.175	3.69	4.44
D	0.015	0.020	0.38	0.51
E	0.050 BSC		1.27 BSC	
F	0.040	0.060	1.02	1.52
G	0.100 BSC		2.54 BSC	
J	0.007	0.012	0.18	0.30
K	0.110	0.140	2.80	3.55
L	0.300 BSC		7.62 BSC	
M	0°	15°	0°	15°
N	0.020	0.040	0.51	1.01

SO-24
DW SUFFIX
 24 PIN PLASTIC SOIC PACKAGE
 CASE 751E-04
 ISSUE E

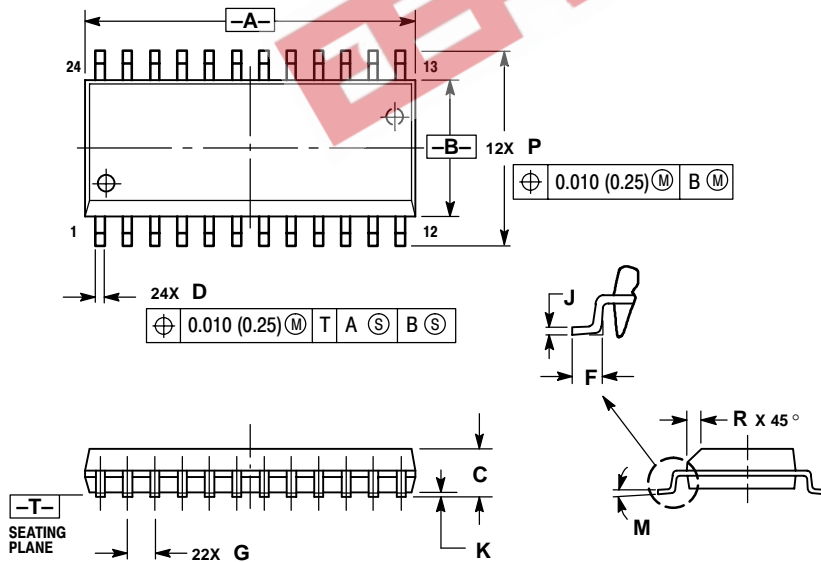

- NOTES:
1. DIMENSIONING AND TOLERANCING PER ANSI Y14.5M, 1982.
 2. CONTROLLING DIMENSION: MILLIMETER.
 3. DIMENSIONS A AND B DO NOT INCLUDE MOLD PROTRUSION.
 4. MAXIMUM MOLD PROTRUSION 0.15 (0.006) PER SIDE.
 5. DIMENSION D DOES NOT INCLUDE DAMBAR PROTRUSION. ALLOWABLE DAMBAR PROTRUSION SHALL BE 0.13 (0.005) TOTAL IN EXCESS OF D DIMENSION AT MAXIMUM MATERIAL CONDITION.

DIM	MILLIMETERS		INCHES	
	MIN	MAX	MIN	MAX
A	15.25	15.54	0.601	0.612
B	7.40	7.60	0.292	0.299
C	2.35	2.65	0.093	0.104
D	0.35	0.49	0.014	0.019
F	0.41	0.90	0.016	0.035
G	1.27 BSC		0.050 BSC	
J	0.23	0.32	0.009	0.013
K	0.13	0.29	0.005	0.011
M	0°	8°	0°	8°
P	10.05	10.55	0.395	0.415
R	0.25	0.75	0.010	0.029

Notes

EEPW 电子产品世界
.com.cn

MC74AC646, MC74ACT646

Notes

EEPW 电子产品世界
.com.cn

MC74AC646, MC74ACT646

EEPW 电子產品世界
.com.cn

ON Semiconductor and  are trademarks of Semiconductor Components Industries, LLC (SCILLC). SCILLC reserves the right to make changes without further notice to any products herein. SCILLC makes no warranty, representation or guarantee regarding the suitability of its products for any particular purpose, nor does SCILLC assume any liability arising out of the application or use of any product or circuit, and specifically disclaims any and all liability, including without limitation special, consequential or incidental damages. "Typical" parameters which may be provided in SCILLC data sheets and/or specifications can and do vary in different applications and actual performance may vary over time. All operating parameters, including "Typicals" must be validated for each customer application by customer's technical experts. SCILLC does not convey any license under its patent rights nor the rights of others. SCILLC products are not designed, intended, or authorized for use as components in systems intended for surgical implant into the body, or other applications intended to support or sustain life, or for any other application in which the failure of the SCILLC product could create a situation where personal injury or death may occur. Should Buyer purchase or use SCILLC products for any such unintended or unauthorized application, Buyer shall indemnify and hold SCILLC and its officers, employees, subsidiaries, affiliates, and distributors harmless against all claims, costs, damages, and expenses, and reasonable attorney fees arising out of, directly or indirectly, any claim of personal injury or death associated with such unintended or unauthorized use, even if such claim alleges that SCILLC was negligent regarding the design or manufacture of the part. SCILLC is an Equal Opportunity/Affirmative Action Employer.

PUBLICATION ORDERING INFORMATION

Literature Fulfillment:

Literature Distribution Center for ON Semiconductor
P.O. Box 5163, Denver, Colorado 80217 USA
Phone: 303-675-2175 or 800-344-3860 Toll Free USA/Canada
Fax: 303-675-2176 or 800-344-3867 Toll Free USA/Canada
Email: ONlit@hibbertco.com

N. American Technical Support: 800-282-9855 Toll Free USA/Canada

JAPAN: ON Semiconductor, Japan Customer Focus Center
4-32-1 Nishi-Gotanda, Shinagawa-ku, Tokyo, Japan 141-0031
Phone: 81-3-5740-2700
Email: r14525@onsemi.com

ON Semiconductor Website: <http://onsemi.com>

For additional information, please contact your local Sales Representative.