



## LM78MXX Series 3-Terminal Positive Voltage Regulators

### General Description

The LM78M00 series of 3-terminal medium current positive voltage regulators employ internal current-limiting, thermal shutdown and safe-area compensation making them essentially indestructible. If adequate heat sinking is provided, they can deliver in excess of 0.5A output current. They are intended as fixed voltage regulators in a wide range of applications including local (on-card) regulation for elimination of noise and distribution problems associated with single-point regulation. In addition to use as fixed voltage regulators, these devices can be used with external components to obtain adjustable output voltages and currents.

### Features

- Output current in excess of 0.5A
- No external components
- Internal thermal overload protection
- Internal short circuit current-limiting
- Output transistor safe-area compensation
- Available in JEDEC TO-220 and TO-39 packages
- Output voltages of 5V, 6V, 8V, 12V, 15V, and 24V

### Connection Diagrams

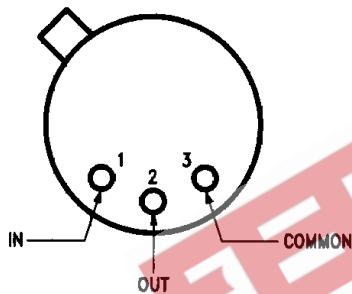

Lead 3 connected to case.

Top View

TL/H/10053-1

**Order Number LM78M05CH, LM78M06CH, LM78M08CH,  
LM78M12CH, LM78M15CH or LM78M24CH**  
See NS Package Number H03B

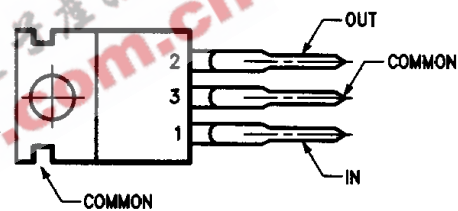

Top View

TL/H/10053-2

Lead 3 connected to tab.

**Order Number LM78M05CT, LM78M06CT, LM78M08CT,  
LM78M12CT, LM78M15CT or LM78M24CT**  
See NS Package Number T03B

## Absolute Maximum Ratings

If Military/Aerospace specified devices are required, please contact the National Semiconductor Sales Office/Distributors for availability and specifications.

Storage Temperature Range

TO-39 Metal Can	-65°C to +175°C
TO-220 Package	-65°C to +150°C

Operating Junction Temperature Range 0°C to +150°C

Lead Temperature

TO-39 Metal Can (Soldering, 60 sec.)	300°C
TO-220 Package (Soldering, 60 sec.)	265°C

Power Dissipation

Internally Limited

Input Voltage

5.0V to 15V	35V
24V	40V

ESD Susceptibility

(to be determined)

## LM78M05C

### Electrical Characteristics

0°C ≤ T<sub>A</sub> ≤ 125°C, V<sub>I</sub> = 10V, I<sub>O</sub> = 350 mA, C<sub>I</sub> = 0.33 μF, C<sub>O</sub> = 0.1 μF, unless otherwise specified

Symbol	Parameter	Conditions (Note 1)	Min	Typ	Max	Units
V <sub>O</sub>	Output Voltage	T <sub>J</sub> = 25°C	4.8	5.0	5.2	V
V <sub>R LINE</sub>	Line Regulation	T <sub>J</sub> = 25°C		3.0	100	mV
		7.0V ≤ V <sub>I</sub> ≤ 25V, I <sub>O</sub> = 200 mA				
				1.0	50	
V <sub>R LOAD</sub>	Load Regulation	T <sub>J</sub> = 25°C		20	100	mV
				10	50	
V <sub>O</sub>	Output Voltage	7.0V ≤ V <sub>I</sub> ≤ 20V, 5.0 mA ≤ I <sub>O</sub> ≤ 350 mA	4.75		5.25	V
I <sub>Q</sub>	Quiescent Current	T <sub>J</sub> = 25°C		4.5	8.0	mA
ΔI <sub>Q</sub>	Quiescent Current Change	with Line			0.8	mA
		with Load			0.5	
N <sub>O</sub>	Noise	T <sub>A</sub> = 25°C, 10 Hz ≤ f ≤ 100 kHz		40		μV
ΔV <sub>I</sub> /ΔV <sub>O</sub>	Ripple Rejection	f = 2400 Hz, I <sub>O</sub> = 125 mA, T <sub>J</sub> = 25°C	62	80		dB
V <sub>DO</sub>	Dropout Voltage	T <sub>A</sub> = 25°C		2.0		V
I <sub>OS</sub>	Output Short Circuit Current	T <sub>J</sub> = 25°C, V <sub>I</sub> = 35V		300		mA
I <sub>pk</sub>	Peak Output Current	T <sub>J</sub> = 25°C		700		mA
ΔV <sub>O</sub> /ΔT	Average Temperature Coefficient of Output Voltage	I <sub>O</sub> = 5.0 mA		1.0		mV/°C

## LM78M06C

### Electrical Characteristics

0°C ≤ T<sub>A</sub> ≤ 125°C, V<sub>I</sub> = 11V, I<sub>O</sub> = 350 mA, C<sub>I</sub> = 0.33 μF, C<sub>O</sub> = 0.1 μF, unless otherwise specified

Symbol	Parameter	Conditions (Note 1)	Min	Typ	Max	Units
V <sub>O</sub>	Output Voltage	T <sub>J</sub> = 25°C	5.75	6.0	6.25	V
V <sub>R LINE</sub>	Line Regulation	T <sub>J</sub> = 25°C		5.0	100	mV
		8.0V ≤ V <sub>I</sub> ≤ 25V, I <sub>O</sub> = 200 mA				
				1.5	50	
V <sub>R LOAD</sub>	Load Regulation	T <sub>J</sub> = 25°C		20	120	mV
				10	60	
V <sub>O</sub>	Output Voltage	8.0V ≤ V <sub>I</sub> ≤ 21V, 5.0 mA ≤ I <sub>O</sub> ≤ 350 mA	5.7		6.3	V
I <sub>Q</sub>	Quiescent Current	T <sub>J</sub> = 25°C		4.5	8.0	mA
ΔI <sub>Q</sub>	Quiescent Current Change	with Line			0.8	mA
		with Load			0.5	

**LM78M06C****Electrical Characteristics** (Continued)
 $0^{\circ}\text{C} \leq T_A \leq 125^{\circ}\text{C}$ ,  $V_I = 11\text{V}$ ,  $I_O = 350\text{ mA}$ ,  $C_I = 0.33\ \mu\text{F}$ ,  $C_O = 0.1\ \mu\text{F}$ , unless otherwise specified.

Symbol	Parameter	Conditions (Note 1)	Min	Typ	Max	Units
$N_O$	Noise	$T_A = 25^{\circ}\text{C}$ , $10\text{ Hz} \leq f \leq 100\text{ kHz}$		45		$\mu\text{V}$
$\Delta V_I/\Delta V_O$	Ripple Rejection	$f = 2400\text{ Hz}$ , $I_O = 125\text{ mA}$ , $T_J = 25^{\circ}\text{C}$	59	80		dB
$V_{DO}$	Dropout Voltage	$T_A = 25^{\circ}\text{C}$		2.0		V
$I_{OS}$	Output Short Circuit Current	$T_J = 25^{\circ}\text{C}$ , $V_I = 35\text{V}$		270		mA
$I_{pk}$	Peak Output Current	$T_J = 25^{\circ}\text{C}$		700		mA
$\Delta V_O/\Delta T$	Average Temperature Coefficient of Output Voltage	$I_O = 5.0\text{ mA}$		0.5		$\text{mV}/^{\circ}\text{C}$

**LM78M08C****Electrical Characteristics**
 $0^{\circ}\text{C} \leq T_A \leq 125^{\circ}\text{C}$ ,  $V_I = 14\text{V}$ ,  $I_O = 350\text{ mA}$ ,  $C_I = 0.33\ \mu\text{F}$ ,  $C_O = 0.1\ \mu\text{F}$ , unless otherwise specified

Symbol	Parameter	Conditions (Note 1)	Min	Typ	Max	Units
$V_O$	Output Voltage	$T_J = 25^{\circ}\text{C}$	7.7	8.0	8.3	V
$V_{R\text{ LINE}}$	Line Regulation	$T_J = 25^{\circ}\text{C}$ $10.5\text{V} \leq V_I \leq 25\text{V}$ , $I_O = 200\text{ mA}$		6.0	100	mV
		$11\text{V} \leq V_I \leq 20\text{V}$ , $I_O = 200\text{ mA}$		2.0	50	
$V_{R\text{ LOAD}}$	Load Regulation	$T_J = 25^{\circ}\text{C}$ $5.0\text{ mA} \leq I_O \leq 500\text{ mA}$		25	160	mV
		$5.0\text{ mA} \leq I_O \leq 200\text{ mA}$		10	80	
$V_O$	Output Voltage	$10.5\text{V} \leq V_I \leq 23\text{V}$ , $5.0\text{ mA} \leq I_O \leq 350\text{ mA}$	7.6		8.4	V
$I_Q$	Quiescent Current	$T_J = 25^{\circ}\text{C}$		4.6	8.0	mA
$\Delta I_Q$	Quiescent Current Change	with Line $10.5\text{V} \leq V_I \leq 25\text{V}$ , $I_O = 200\text{ mA}$			0.8	mA
		with Load $5.0\text{ mA} \leq I_O \leq 350\text{ mA}$			0.5	
$N_O$	Noise	$T_A = 25^{\circ}\text{C}$ , $10\text{ Hz} \leq f \leq 100\text{ kHz}$		52		$\mu\text{V}$
$\Delta V_I/\Delta V_O$	Ripple Rejection	$f = 2400\text{ Hz}$ , $I_O = 125\text{ mA}$ , $T_J = 25^{\circ}\text{C}$	56	80		dB
$V_{DO}$	Dropout Voltage	$T_A = 25^{\circ}\text{C}$		2.0		V
$I_{OS}$	Output Short Circuit Current	$T_J = 25^{\circ}\text{C}$ , $V_I = 35\text{V}$		250		mA
$I_{pk}$	Peak Output Current	$T_J = 25^{\circ}\text{C}$		700		mA
$\Delta V_O/\Delta T$	Average Temperature Coefficient of Output Voltage	$I_O = 5.0\text{ mA}$		0.5		$\text{mV}/^{\circ}\text{C}$

**LM78M12C****Electrical Characteristics**
 $0^{\circ}\text{C} \leq T_A \leq 125^{\circ}\text{C}$ ,  $V_I = 19\text{V}$ ,  $I_O = 350\text{ mA}$ ,  $C_I = 0.33\ \mu\text{F}$ ,  $C_O = 0.1\ \mu\text{F}$ , unless otherwise specified

Symbol	Parameter	Conditions (Note 1)	Min	Typ	Max	Units
$V_O$	Output Voltage	$T_J = 25^{\circ}\text{C}$	11.5	12.0	12.5	V
$V_{R\text{ LINE}}$	Line Regulation	$T_J = 25^{\circ}\text{C}$ $14.5\text{V} \leq V_I \leq 30\text{V}$ , $I_O = 200\text{ mA}$		8.0	100	mV
		$16\text{V} \leq V_I \leq 25\text{V}$ , $I_O = 200\text{ mA}$		2.0	50	

**LM78M12C****Electrical Characteristics** (Continued)
 $0^{\circ}\text{C} \leq T_A \leq 125^{\circ}\text{C}$ ,  $V_I = 19\text{V}$ ,  $I_O = 350\text{ mA}$ ,  $C_I = 0.33\ \mu\text{F}$ ,  $C_O = 0.1\ \mu\text{F}$ , unless otherwise specified

Symbol	Parameter	Conditions (Note 1)	Min	Typ	Max	Units
$V_{R\text{ LOAD}}$	Load Regulation	$T_J = 25^{\circ}\text{C}$		25	240	mV
		$5.0\text{ mA} \leq I_O \leq 500\text{ mA}$		10	120	
$V_O$	Output Voltage	$14.5\text{V} \leq V_I \leq 27\text{V}$ , $5.0\text{ mA} \leq I_O \leq 350\text{ mA}$	11.4		12.6	V
$I_Q$	Quiescent Current	$T_J = 25^{\circ}\text{C}$		4.8	8.0	mA
$\Delta I_Q$	Quiescent Current Change	with Line	$14.5\text{V} \leq V_I \leq 30\text{V}$ , $I_O = 200\text{ mA}$		0.8	mA
		with Load	$5.0\text{ mA} \leq I_O \leq 350\text{ mA}$		0.5	
$N_O$	Noise	$T_A = 25^{\circ}\text{C}$ , $10\text{ Hz} \leq f \leq 100\text{ kHz}$		75		$\mu\text{V}$
$\Delta V_I/\Delta V_O$	Ripple Rejection	$f = 2400\text{ Hz}$ , $I_O = 125\text{ mA}$ , $V_I = 17\text{V}$ , $T_J = 25^{\circ}\text{C}$	55	80		dB
$V_{DO}$	Dropout Voltage	$T_A = 25^{\circ}\text{C}$		2.0		V
$I_{OS}$	Output Short Circuit Current	$T_J = 25^{\circ}\text{C}$ , $V_I = 35\text{V}$		240		mA
$I_{pk}$	Peak Output Current	$T_J = 25^{\circ}\text{C}$		700		mA
$\Delta V_O/\Delta T$	Average Temperature Coefficient of Output Voltage	$I_O = 5.0\text{ mA}$		1.0		$\text{mV}/^{\circ}\text{C}$

**LM78M15C****Electrical Characteristics**
 $0^{\circ}\text{C} \leq T_A \leq 125^{\circ}\text{C}$ ,  $V_I = 23\text{V}$ ,  $I_O = 350\text{ mA}$ ,  $C_I = 0.33\ \mu\text{F}$ ,  $C_O = 0.1\ \mu\text{F}$ , unless otherwise specified (Continued)

Symbol	Parameter	Conditions (Note 1)	Min	Typ	Max	Units
$V_O$	Output Voltage	$T_J = 25^{\circ}\text{C}$	14.4	15.0	15.6	V
$V_{R\text{ LINE}}$	Line Regulation	$T_J = 25^{\circ}\text{C}$		10	100	mV
		$17.5\text{V} \leq V_I \leq 30\text{V}$ , $I_O = 200\text{ mA}$		3.0	50	
$V_{R\text{ LOAD}}$	Load Regulation	$T_J = 25^{\circ}\text{C}$		25	300	mV
		$5.0\text{ mA} \leq I_O \leq 500\text{ mA}$		10	150	
$V_O$	Output Voltage	$17.5\text{V} \leq V_I \leq 30\text{V}$ , $5.0\text{ mA} \leq I_O \leq 350\text{ mA}$	14.25		15.75	V
$I_Q$	Quiescent Current	$T_J = 25^{\circ}\text{C}$		4.8	8.0	mA
$\Delta I_Q$	Quiescent Current Change	with Line	$17.5\text{V} \leq V_I \leq 30\text{V}$ , $I_O = 200\text{ mA}$		0.8	mA
		with Load	$5.0\text{ mA} \leq I_O \leq 350\text{ mA}$		0.5	
$N_O$	Noise	$T_A = 25^{\circ}\text{C}$ , $10\text{ Hz} \leq f \leq 100\text{ kHz}$		90		$\mu\text{V}$
$\Delta V_I/\Delta V_O$	Ripple Rejection	$f = 2400\text{ Hz}$ , $I_O = 125\text{ mA}$ , $V_I = 20\text{V}$ , $T_J = 25^{\circ}\text{C}$	54	70		dB
$V_{DO}$	Dropout Voltage	$T_A = 25^{\circ}\text{C}$		2.0		V
$I_{OS}$	Output Short Circuit Current	$T_J = 25^{\circ}\text{C}$ , $V_I = 35\text{V}$		240		mA
$I_{pk}$	Peak Output Current	$T_J = 25^{\circ}\text{C}$		700		mA
$\Delta V_O/\Delta T$	Average Temperature Coefficient of Output Voltage	$I_O = 5.0\text{ mA}$		1.0		$\text{mV}/^{\circ}\text{C}$

## LM78M24C

### Electrical Characteristics

$0^{\circ}\text{C} \leq T_A \leq 125^{\circ}\text{C}$ ,  $V_I = 33\text{V}$ ,  $I_O = 350\text{ mA}$ ,  $C_I = 0.33\ \mu\text{F}$ ,  $C_O = 0.1\ \mu\text{F}$ , unless otherwise specified

Symbol	Parameter	Conditions (Note 1)	Min	Typ	Max	Units
$V_O$	Output Voltage	$T_J = 25^{\circ}\text{C}$	23.0	24.0	25.0	V
$V_{R\text{ LINE}}$	Line Regulation	$T_J = 25^{\circ}\text{C}$ $27\text{V} \leq V_I \leq 38\text{V}$ , $I_O = 200\text{ mA}$		10	100	mV
		$28\text{V} \leq V_I \leq 36\text{V}$ , $I_O = 200\text{ mA}$		5.0	50	
$V_{R\text{ LOAD}}$	Load Regulation	$T_J = 25^{\circ}\text{C}$ $5.0\text{ mA} \leq I_O \leq 500\text{ mA}$		30	480	mV
		$5.0\text{ mA} \leq I_O \leq 200\text{ mA}$		10	240	
$V_O$	Output Voltage	$27\text{V} \leq V_I \leq 38\text{V}$ , $5.0\text{ mA} \leq I_O \leq 350\text{ mA}$	22.8		25.2	V
$I_Q$	Quiescent Current	$T_J = 25^{\circ}\text{C}$		5.0	8.0	mA
$\Delta I_Q$	Quiescent Current Change	with Line			0.8	mA
		with Load			0.5	
$N_O$	Noise	$T_A = 25^{\circ}\text{C}$ , $10\text{ Hz} \leq f \leq 100\text{ kHz}$		170		$\mu\text{V}$
$\Delta V_I / \Delta V_O$	Ripple Rejection	$f = 2400\text{ Hz}$ , $I_O = 125\text{ mA}$ , $V_I = 30\text{V}$ , $T_J = 25^{\circ}\text{C}$	50	70		dB
$V_{DO}$	Dropout Voltage	$T_A = 25^{\circ}\text{C}$		2.0		V
$I_{OS}$	Output Short Circuit Current	$T_J = 35^{\circ}\text{C}$ , $V_I = 35\text{V}$		240		mA
$I_{pk}$	Peak Output Current	$T_J = 25^{\circ}\text{C}$		700		mA
$\Delta V_O / \Delta T$	Average Temperature Coefficient of Output Voltage	$I_O = 5.0\text{ mA}$		1.2		$\text{mV}/^{\circ}\text{C}$

**Note 1:** All characteristics except noise voltage and ripple rejection ratio are measured using pulse techniques ( $T_W \leq 10\text{ ms}$ , duty cycle  $\leq 5\%$ ). Output voltage changes due to changes in internal temperature must be taken into account separately.

### Equivalent Circuit

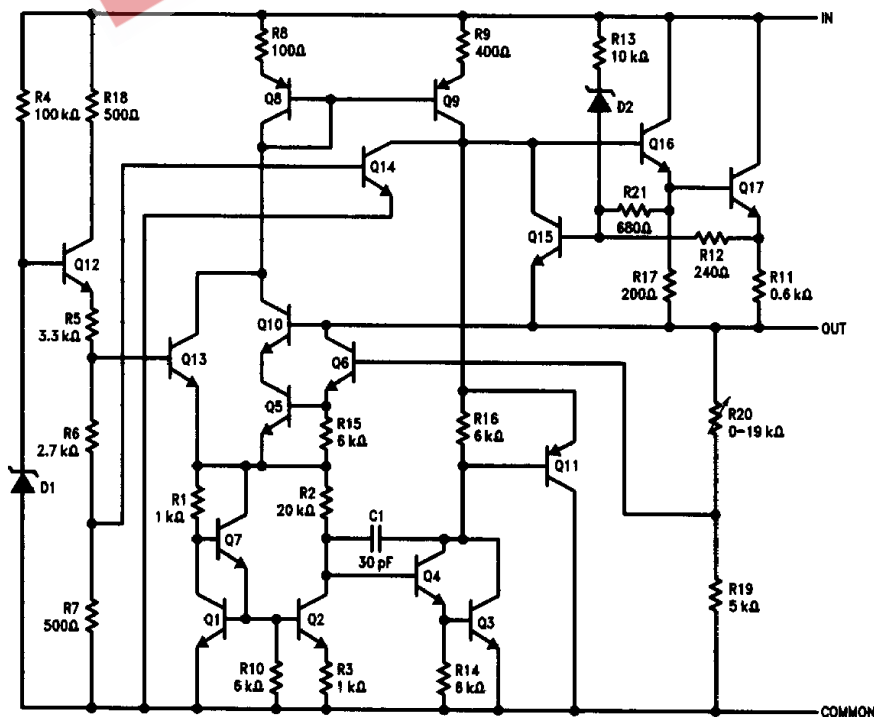

TL/H/10053-3

# Typical Performance Characteristics

**Worst Case Power Dissipation vs Ambient Temperature (TO-39)**

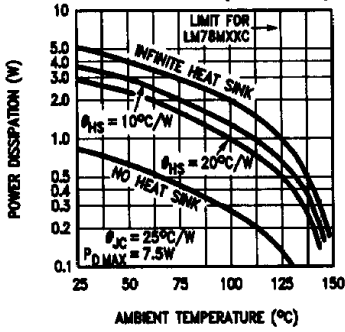

**Worst Case Power Dissipation vs Ambient Temperature (TO-220)**

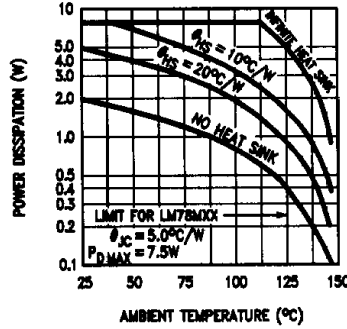

**Peak Output Current vs Input/Output Voltage Differential**

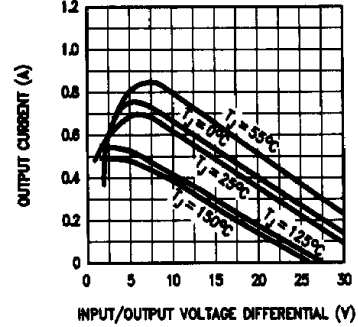

**Output Voltage vs Junction Temperature**

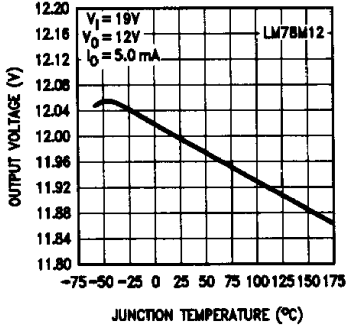

**Dropout Voltage vs Junction Temperature**

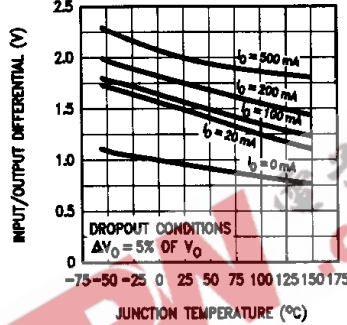

**Dropout Characteristics**

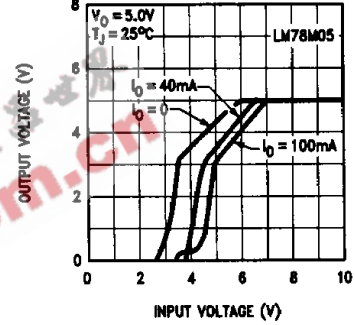

**Quiescent Current vs Input Voltage**

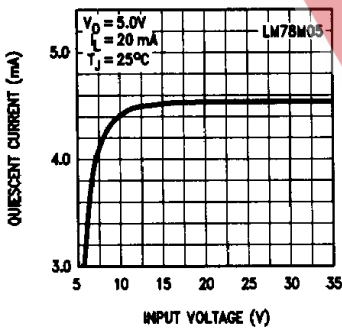

**Quiescent Current vs Temperature**

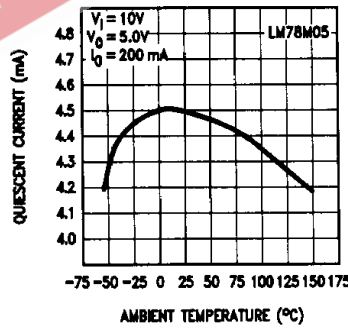

**Ripple Rejection vs Frequency**

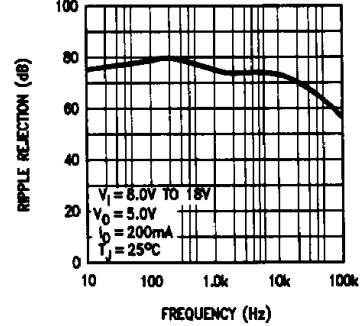

Note: Other LM78M00 Series devices have similar curves.

TL/H/10053-4

## Typical Performance Characteristics (Continued)

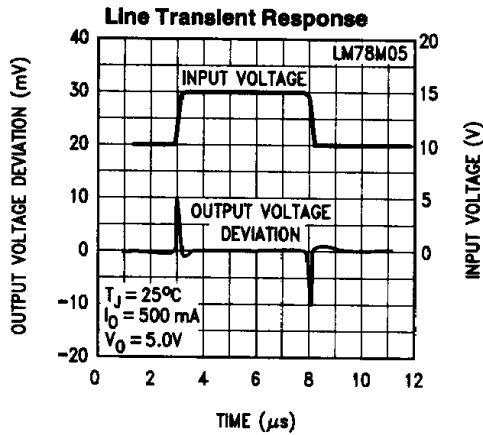

TL/H/10053-5

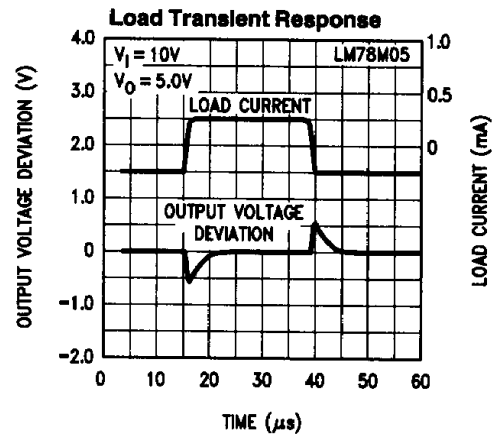

TL/H/10053-6

### Design Considerations

The LM78MXX fixed voltage regulator series has thermal-overload protection from excessive power, internal short circuit protection which limits the circuit's maximum current, and output transistor safe-area compensation for reducing the output short circuit current as the voltage across the pass transistor is increased.

Although the internal power dissipation is limited, the junction temperature must be kept below the maximum specified temperature (+125°C for LM78MXXC) in order to meet data sheet specifications. To calculate the maximum junction temperature or heat sink required, the following thermal resistance values should be used:

Package	Typ $\theta_{JC}$	Max $\theta_{JC}$	Typ $\theta_{JA}$	Max $\theta_{JA}$
TO-39	18	25	120	140
TO-220	3.0	5.0	60	40

$$P_{D \text{ Max}} = \frac{T_{J \text{ Max}} - T_A}{\theta_{JC} + \theta_{CA}} \text{ or}$$

$$= \frac{T_{J \text{ Max}} - T_A}{\theta_{JA}} \text{ (Without a Heat Sink)}$$

$$\theta_{CA} = \theta_{CS} + \theta_{SA}$$

Solving for  $T_J$ :

$$T_J = T_A + P_D (\theta_{JC} + \theta_{CA}) \text{ or}$$

$$= T_A + P_D \theta_{JA} \text{ (Without a Heat Sink)}$$

Where:

- $T_J$  = Junction Temperature
- $T_A$  = Ambient Temperature
- $P_D$  = Power Dissipation
- $\theta_{JC}$  = Junction to Case Thermal Resistance
- $\theta_{CA}$  = Case-to-Ambient Thermal Resistance
- $\theta_{CS}$  = Case-to-Heat Sink to Resistance
- $\theta_{SA}$  = Heat Sink-to-Ambient Thermal Resistance
- $\theta_{JA}$  = Junction-to-Ambient Thermal Resistance

### Typical Applications

#### Fixed Output Regulator

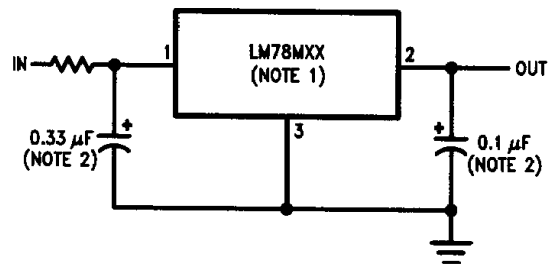

TL/H/10053-7

**Note 1:** To specify an output voltage, substitute voltage value for "XX".

**Note 2:** Bypass capacitors are recommended for optimum stability and transient response and should be located as close as possible to the regulator.