

# 3.3V CMOS Ultra-Low Jitter Voltage Control VCXO

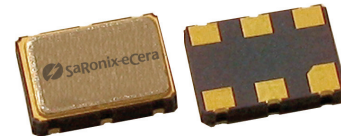

Actual Size = 5 x 7mm



## Product Features

- Cost-effective design
- LVCMOS compatible output
- Commercial and industrial operation
- $\pm 50$  ppm stability (or as specified)
- $\pm 50$  to  $\pm 100$  ppm absolute (net) pull range
- RoHS Compliant

## Product Description

The YN is a voltage controlled crystal oscillator with wide pullability over a broad range of operating conditions and frequencies. The device is constructed with a hermetically sealed, quartz crystal resonator and low noise clock IC. The device, available on tape and reel, is contained in a 5x7mm ceramic package.

## Applications

The YN Series VCXO is an ideal component in phase locked loop circuits that perform clock smoothing, clock/data recovery, or frequency translation and card synchronization functions, such as:

- SD/HD Video decoding
- SONET/SDH timing control and line cards
- T3/E3 Platforms
- Satellite and microwave communications
- Wireless base stations
- xDSL and DSLAM
- VoIP

## Packaging Outline

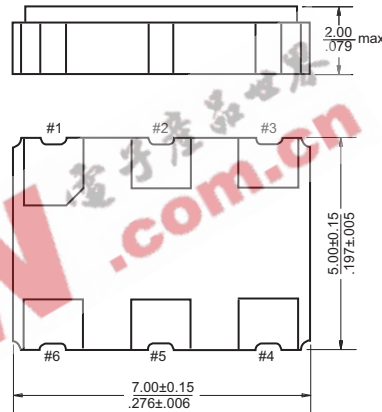

## Pin Functions

Pad	Function
1	Control voltage
2	Output Enable/Disable
3	Ground
4	Output
5	No Connect
6	Supply voltage

Dimensions are in mm/inches.

## New Part Number Example

**YN C50 0001** A = Product Family  
B = Frequency Code  
C = Specification Code

Note: After July 1, 2007, a Saronix - eCera part number following the above format will be assigned upon confirmation of exact customer requirements.

## Legacy Ordering Information (for reference only)

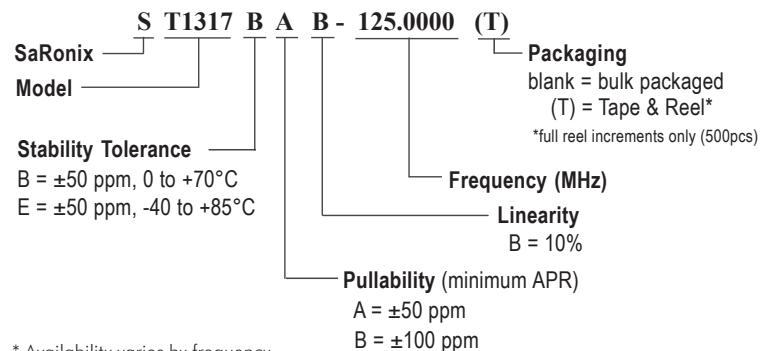

\* Availability varies by frequency.

# 3.3V CMOS Ultra Low Jitter Voltage Control (VCXO)



YN Series Crystal Oscillator  
Legacy ST1317 Series  
7.0x5.0mm

## Electrical Performance

Parameter	Min.	Typ.	Max.	Units	Notes
Output frequency ( $F_N$ )	32.0		125.0	MHz	As specified
Supply voltage	+2.97	+3.3	+3.63	V	
Supply current			35	mA	
Frequency stability			±50	ppM	See #1 and #2 below
Operating temperature	-40		+85	°C	As specified
Output logic 0, $V_{OL}$			10% $V_{DD}$	V	Capacitive load
Output logic 0, $V_{OL}$			20% $V_{DD}$	V	AC coupled load
Output logic 1, $V_{OH}$	90% $V_{DD}$			V	Capacitive load
Output logic 1, $V_{OH}$	80% $V_{DD}$			V	AC coupled load
Output load			30	pF	Up to 80 MHz
Output load			95	$\Omega$ AC	Up to 125 MHz
Duty cycle	45		55	%	measured 50% $V_{DD}$ (0 to +70°C)
Duty cycle	40		60	%	measured 50% $V_{DD}$ (-40 to +85°C)
Rise and fall time			4	ns	measured 20/80% $V_{DD}$
Jitter, total			100	ps pk-pk	
Jitter, total			20	ps RMS	
Phase noise		-95		dBc/Hz	100 Hz offset
Phase noise		-110		dBc/Hz	1 kHz offset
Phase noise		-100		dBc/Hz	10 kHz offset

### Notes:

- As specified. Stability includes all combinations of operating temperature, load changes, rated input (supply) voltage changes, shock and vibration, with control voltage held at center.
- ±12 ppM max due to aging (10 years at 40°C average ambient operating temperature).

## Frequency Modulation Function

Parameter	Min.	Typ.	Max.	Units	Notes
Absolute pull range (APR)	±50 to ±100			ppM	See #1 below
Control voltage range	+0.3		+3.0	$V_{DC}$	As rated
Center control voltage		+1.65		V	For RMT center frequency
Monotonic linearity			10	%	Positive transfer slope
Input impedance	50			k $\Omega$	Control voltage pin
Modulation bandwidth	50			kHz	-3dB

### Notes:

- As specified. APR is relative to the nominal output frequency  $F_N$ ; APR is inclusive (net) of frequency deviation due to stability.

# 3.3V CMOS Ultra Low Jitter Voltage Control (VCXO) YN



YN Series Crystal Oscillator  
Legacy ST1317 Series  
7.0x5.0mm

## Output Enable / Disable Function

Parameter	Min.	Typ.	Max.	Units	Notes
Input voltage, output enable	3.0			V	or open
Input voltage, output high impedance			0.3	V	Output is high impedance

## Absolute Maximum Ratings

Parameter	Min.	Typ.	Max.	Units	Notes
Storage temperature	-55		+125	°C	
Control voltage range	-0.5		V <sub>DD</sub> +0.5	V	

## Test Circuit

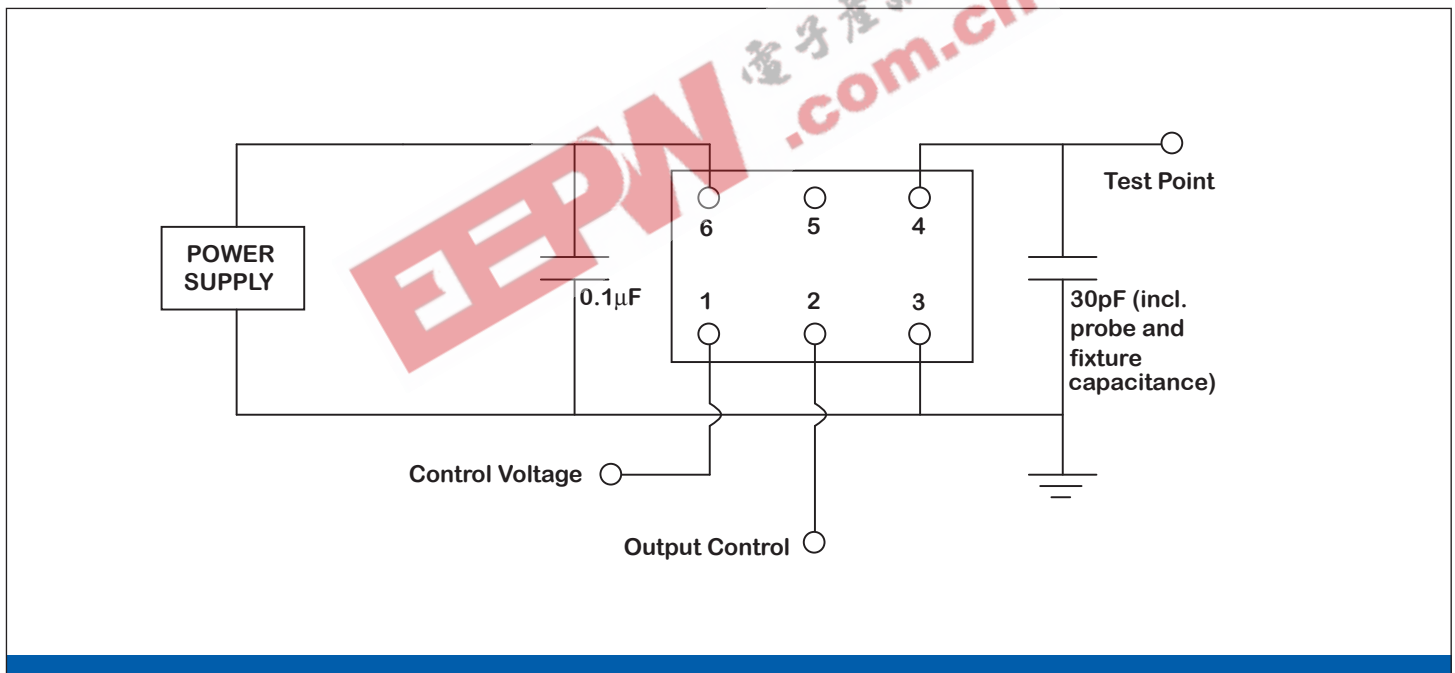

# 3.3V CMOS Ultra Low Jitter Voltage Control (VCXO)



YN Series Crystal Oscillator  
Legacy ST1317 Series  
7.0x5.0mm

## Test Circuit (AC Coupled Load)

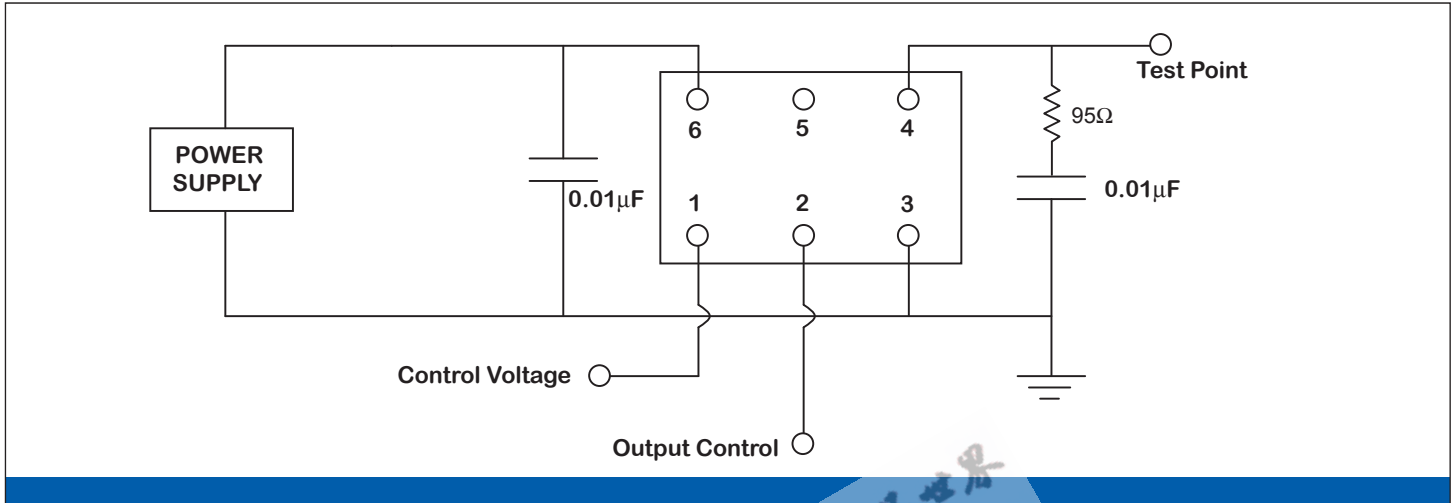

## Output Waveform

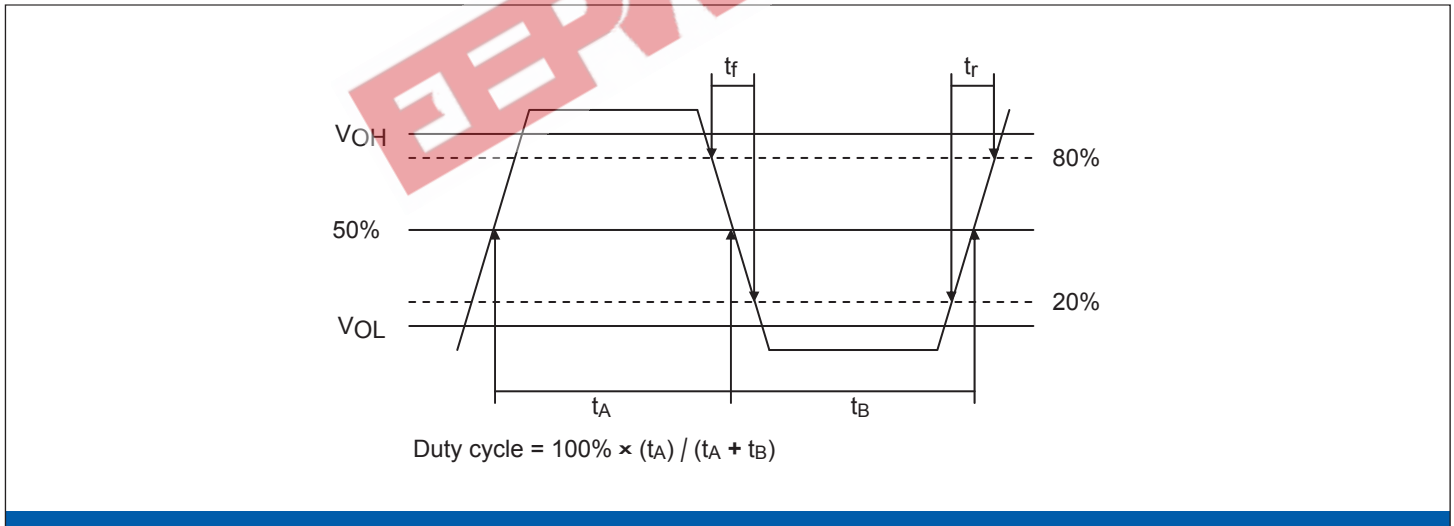

## Solder Reflow Guide

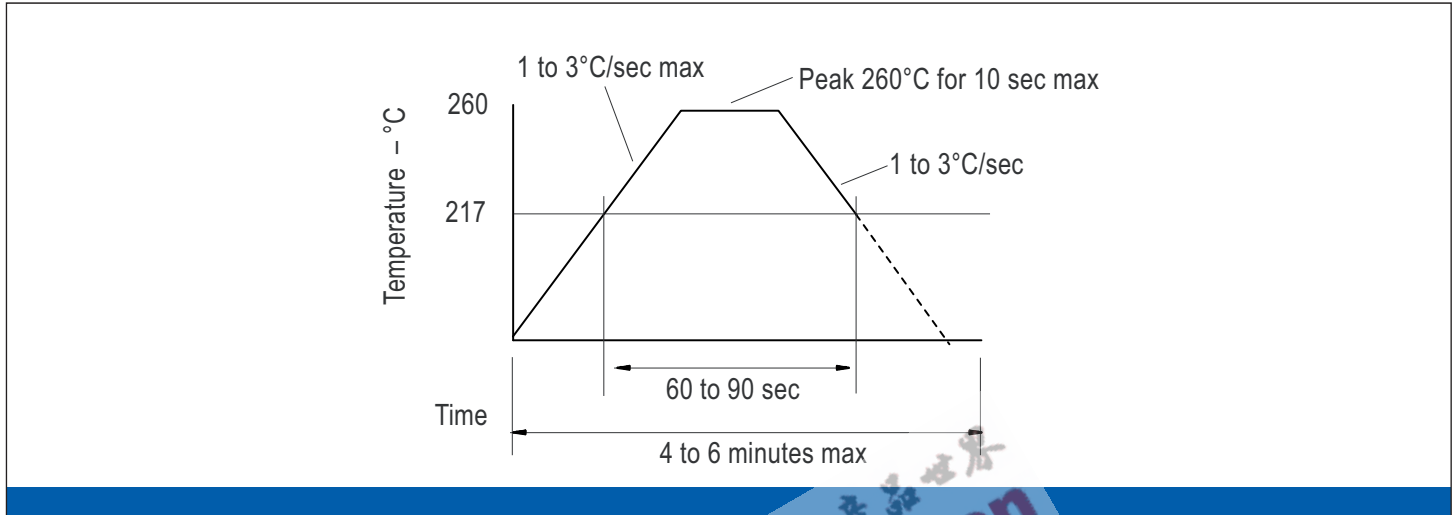

## Reliability Test Ratings

This product is rated to meet the following test conditions:

Type	Parameter	Test Condition
Mechanical	Shock	MIL-STD-883, Method 2002, Condition B
Mechanical	Solderability	JESD22-B102-D Method 2 (Preconditioning E)
Mechanical	Terminal strength	MIL-STD-883, Method 2004, Condition D
Mechanical	Solvent resistance	MIL-STD-202, Method 215
Environmental	Thermal shock	MIL-STD-883, Method 1011, Condition A
Environmental	Moisture resistance	MIL-STD-883, Method 1004
Environmental	Vibration	MIL-STD-883, Method 2007, Condition A
Environmental	Resistance to soldering heat	J-STD-020C Table 5-2 Pb-free devices (2 cycles max)

Mechanical Drawings

