

DATA SHEET

TDA3673

Very low dropout voltage/quiescent current 3.3 V voltage regulator with enable

Preliminary specification
Supersedes data of 1999 Sep 29
File under Integrated Circuits, IC01

2000 Feb 01

Very low dropout voltage/quiescent current 3.3 V voltage regulator with enable

TDA3673

FEATURES

- Fixed 3.3 V, 100 mA regulator with enable function
- Supply voltage range up to 33 V (45 V)
- Very low quiescent current of 15 μ A (typical value)
- Very low dropout voltage
- High ripple rejection
- Very high stability:
 - Electrolytic capacitors: Equivalent Series Resistance (ESR) < 38 Ω at $I_{REG} \leq 25$ mA
 - Other capacitors: 100 nF at $200 \mu\text{A} \leq I_{REG} \leq 100$ mA.
- Pin compatible family TDA3672 to TDA3676
- Protections:
 - Reverse polarity safe (down to -25 V without high reverse current)
 - Negative transient of 50 V ($R_S = 10 \Omega$, $t < 100$ ms)

- Able to withstand voltages up to 18 V at the output (supply line may be short-circuited)
- ESD protection on all pins
- DC short-circuit safe to ground and V_P of the regulator output
- Temperature protection (at $T_j > 150$ $^{\circ}\text{C}$).

GENERAL DESCRIPTION

The TDA3673 is a fixed 3.3 V voltage regulator with very low dropout voltage and quiescent current, which operates over a wide supply voltage range.

The IC is available as:

- TDA3673T: $V_P \leq 33$ V, -40 $^{\circ}\text{C} \leq T_{amb} \leq +85$ $^{\circ}\text{C}$ and SO8 package (non-automotive)
- TDA3673AT: $V_P \leq 45$ V, -40 $^{\circ}\text{C} \leq T_{amb} \leq +125$ $^{\circ}\text{C}$ and SO8 package (automotive).

QUICK REFERENCE DATA

SYMBOL	PARAMETER	CONDITIONS	MIN.	TYP.	MAX.	UNIT
Supply						
V_P	supply voltage	regulator on				
	TDA3673T		3	14.4	33	V
	TDA3673AT		3	14.4	45	V
I_q	quiescent supply current	$V_P = 14.4$ V; $I_{REG} = 0$ mA; $V_{I(EN)} = 5$ V	–	15	30	μ A
Voltage regulator						
V_{REG}	output voltage	$8 \text{ V} \leq V_P \leq 22 \text{ V}$; $I_{REG} = 0.5$ mA	3.16	3.3	3.44	V
		$6 \text{ V} \leq V_P \leq 45 \text{ V}$; $I_{REG} = 0.5$ mA	3.13	3.3	3.47	V
		$0.5 \text{ mA} \leq I_{REG} \leq 100 \text{ mA}$; $V_P = 14.4$ V	3.13	3.3	3.47	V
$V_{REG(drop)}$	dropout voltage	$V_P = 3.1$ V; $I_{REG} = 50$ mA; $T_{amb} \leq 85$ $^{\circ}\text{C}$	–	0.18	0.3	V

ORDERING INFORMATION

TYPE NUMBER	PACKAGE		
	NAME	DESCRIPTION	VERSION
TDA3673T	SO8	plastic small outline package; 8 leads; body width 3.9 mm	SOT96-1
TDA3673AT	SO8	plastic small outline package; 8 leads; body width 3.9 mm	SOT96-1

Very low dropout voltage/quiescent current
3.3 V voltage regulator with enable

TDA3673

BLOCK DIAGRAM

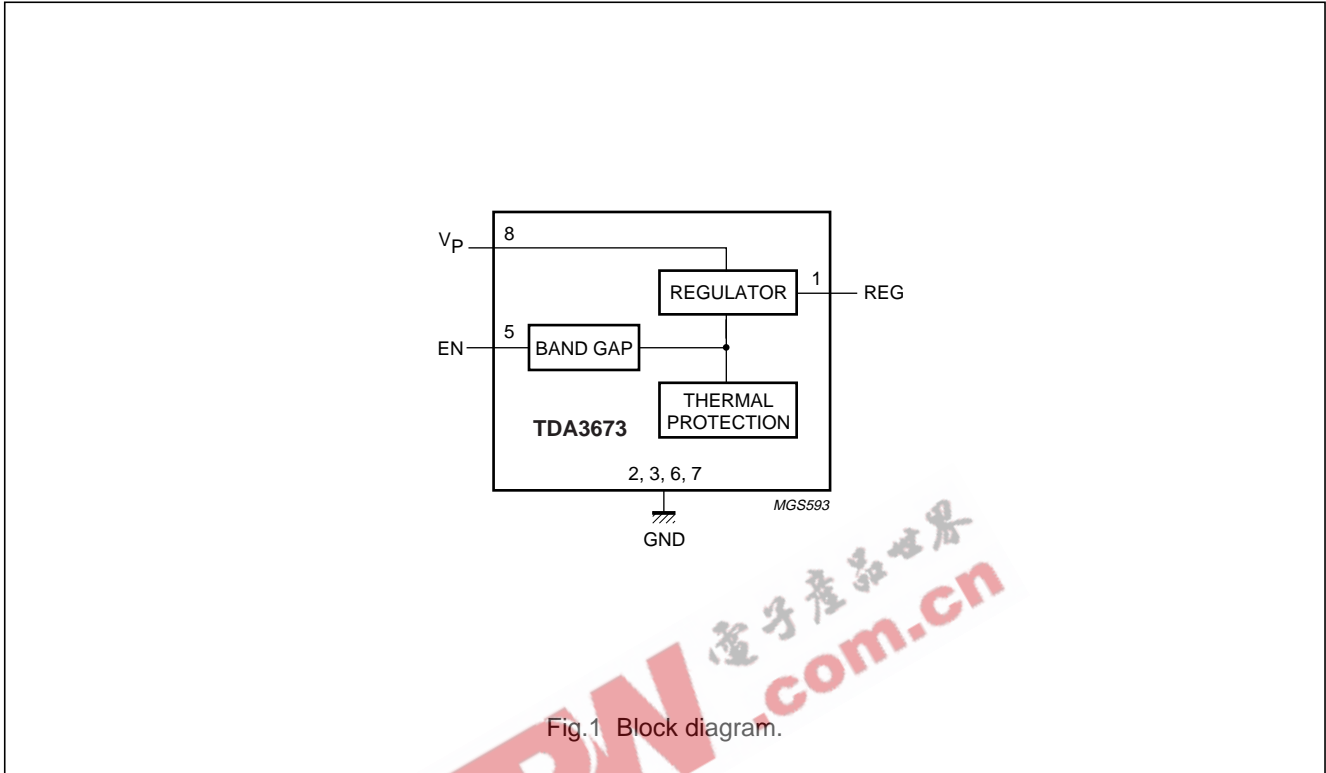

PINNING

SYMBOL	PIN	DESCRIPTION
REG	1	regulator output
GND	2, 3, 6 and 7	ground; note 1
n.c.	4	not connected
EN	5	enable input
VP	8	supply voltage

Note

- All GND pins are connected to the lead frame and can also be used to reduce the total thermal resistance $R_{th(j-a)}$ by soldering these pins to a ground plane. The ground plane on the top side of the PCB acts like a heat spreader.

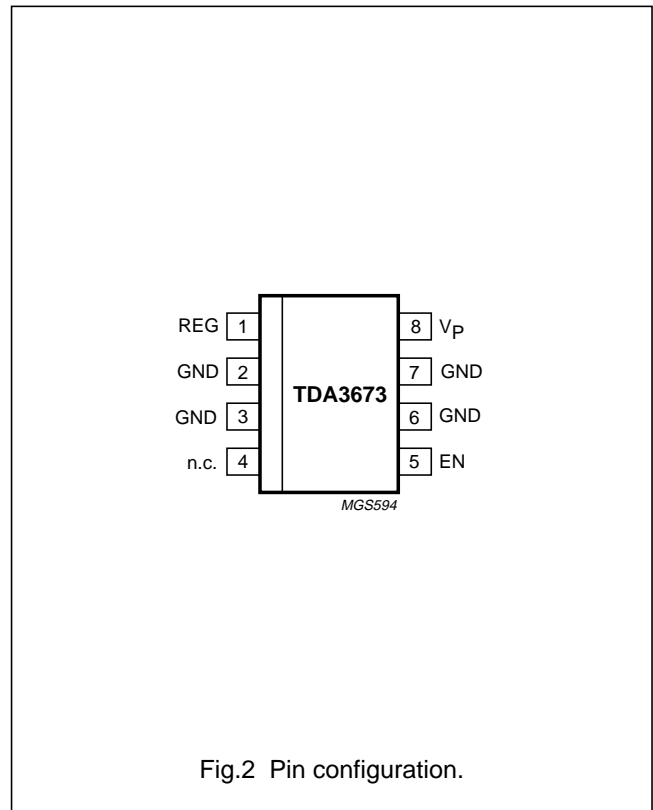

Very low dropout voltage/quiescent current 3.3 V voltage regulator with enable

TDA3673

FUNCTIONAL DESCRIPTION

The TDA3673 is a fixed 3.3 V regulator which can deliver output currents up to 100 mA. The regulator is available in an SO8 package with fused centre pins connected to the lead frame. The regulator is intended for portable, mains, telephone and automotive applications. To increase the lifetime of batteries, a specially built-in clamp circuit keeps the quiescent current of this regulator very low, also in dropout and full load conditions.

The regulator remains operating down to very low supply voltages and below it switches off.

A temperature protection circuit is included, which switches off the regulator output at a junction temperature above 150 °C.

A new output circuit guarantees the stability of the regulator for a capacitor output circuit with an ESR up to 20 Ω. If only a 100 nF capacitor is used, the regulator is fully stable when $I_{REG} > 200 \mu\text{A}$. This is very attractive as the ESR of an electrolytic capacitor increases strongly at low temperatures (no expensive tantalum capacitor is required).

LIMITING VALUES

In accordance with the Absolute Maximum Rating System (IEC 134).

SYMBOL	PARAMETER	CONDITIONS	MIN.	MAX.	UNIT
V_P	supply voltage				
	TDA3673T		–	33	V
	TDA3673AT		–	45	V
$V_{P(rp)}$	reverse polarity supply voltage	non-operating	–	–25	V
P_{tot}	total power dissipation	temperature of copper area is 25 °C	–	4.1	W
T_{stg}	storage temperature	non-operating	–55	+150	°C
T_{amb}	ambient temperature	operating			
	TDA3673T		–40	+85	°C
	TDA3673AT		–40	+125	°C
T_j	junction temperature	operating	–40	+150	°C

THERMAL CHARACTERISTICS

SYMBOL	PARAMETER	CONDITIONS	VALUE	UNIT
$R_{th(j-a)}$	thermal resistance from junction to ambient	in free air; soldered	125	K/W
$R_{th(j-c)}$	thermal resistance from junction to case	to centre pins; soldered	30	K/W

QUALITY SPECIFICATION

In accordance with "SNW-FQ-611E".

Very low dropout voltage/quiescent current 3.3 V voltage regulator with enable

TDA3673

CHARACTERISTICS $V_P = 14.4\text{ V}$; $T_{\text{amb}} = 25\text{ °C}$; measured in test circuit of Fig.3; unless otherwise specified.

SYMBOL	PARAMETER	CONDITIONS	MIN.	TYP.	MAX.	UNIT
Supply voltage: pin V_P						
V_P	supply voltage	regulator operating; note 1				
	TDA3673T		3	14.4	33	V
	TDA3673AT		3	14.4	45	V
I_q	quiescent current	$V_P = 14.4\text{ V}$; $I_{\text{REG}} = 0\text{ mA}$; $V_{\text{I(EN)}} = 0\text{ V}$	–	4	15	μA
		$V_P = 14.4\text{ V}$; $I_{\text{REG}} = 0\text{ mA}$; $V_{\text{I(EN)}} = 5\text{ V}$	–	15	30	μA
		$6\text{ V} \leq V_P \leq 22\text{ V}$; $I_{\text{REG}} = 10\text{ mA}$	–	0.2	0.5	mA
		$6\text{ V} \leq V_P \leq 22\text{ V}$; $I_{\text{REG}} = 50\text{ mA}$	–	1.4	2.5	mA
Enable input: pin EN						
$V_{\text{I(EN)}}$	enable input voltage	enable off; $V_{\text{REG}} \leq 0.8\text{ V}$	–1	–	+1.0	V
		enable on; $V_{\text{REG}} \geq 3\text{ V}$	3.0	–	18	V
$I_{\text{I(EN)}}$	enable input current	$V_{\text{I(EN)}} = 5\text{ V}$	–	0.3	–	μA
Regulator output: pin REG; note 2						
V_{REG}	output voltage	$8\text{ V} \leq V_P \leq 22\text{ V}$; $I_{\text{REG}} = 0.5\text{ mA}$	3.16	3.3	3.44	V
		$0.5\text{ mA} \leq I_{\text{REG}} \leq 100\text{ mA}$	3.13	3.3	3.47	V
		$6\text{ V} \leq V_P \leq 45\text{ V}$; $I_{\text{REG}} = 0.5\text{ mA}$	3.13	3.3	3.47	V
$V_{\text{REG(drop)}}$	dropout voltage	$V_P = 3.1\text{ V}$; $T_{\text{amb}} \leq 85\text{ °C}$; $I_{\text{REG}} = 50\text{ mA}$	–	0.18	0.3	V
$V_{\text{REG(stab)}}$	long-term output voltage stability		–	20	–	mV/1000 h
$\Delta V_{\text{REG(line)}}$	line input regulation voltage	$7\text{ V} \leq V_P \leq 22\text{ V}$; $I_{\text{REG}} = 0.5\text{ mA}$	–	1	30	mV
		$7\text{ V} \leq V_P \leq 45\text{ V}$; $I_{\text{REG}} = 0.5\text{ mA}$	–	1	50	mV
$\Delta V_{\text{REG(load)}}$	load output regulation voltage	$0.5\text{ mA} \leq I_{\text{REG}} \leq 50\text{ mA}$	–	10	50	mV
SVRR	supply voltage ripple rejection	$f_i = 120\text{ Hz}$; $V_{\text{i(ripple)}} = 1\text{ V (RMS)}$; $I_{\text{REG}} = 0.5\text{ mA}$	50	60	–	dB
$I_{\text{REG(crl)}}$	current limit	$V_{\text{REG}} > 2.8\text{ V}$	0.17	0.25	–	A
$I_{\text{LO(rp)}}$	output leakage current at reverse polarity input	$V_P = -15\text{ V}$; $V_{\text{REG}} \leq 0.3\text{ V}$	–	1	500	μA

Notes

- The regulator output will follow V_P if $V_P < V_{\text{REG}} + V_{\text{REG(drop)}}$.
- Limiting values as applicable for device type:
 - TDA3673T: $V_P \leq 33\text{ V}$ and $-40\text{ °C} \leq T_{\text{amb}} \leq +85\text{ °C}$.
 - TDA3673AT: $V_P \leq 45\text{ V}$ and $-40\text{ °C} \leq T_{\text{amb}} \leq +125\text{ °C}$.

Very low dropout voltage/quiescent current
3.3 V voltage regulator with enable

TDA3673

TEST AND APPLICATION INFORMATION

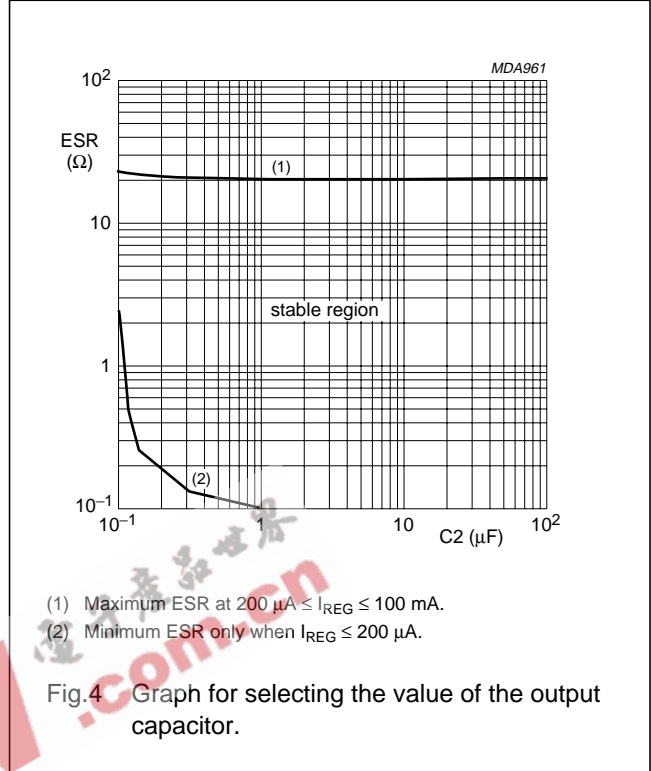
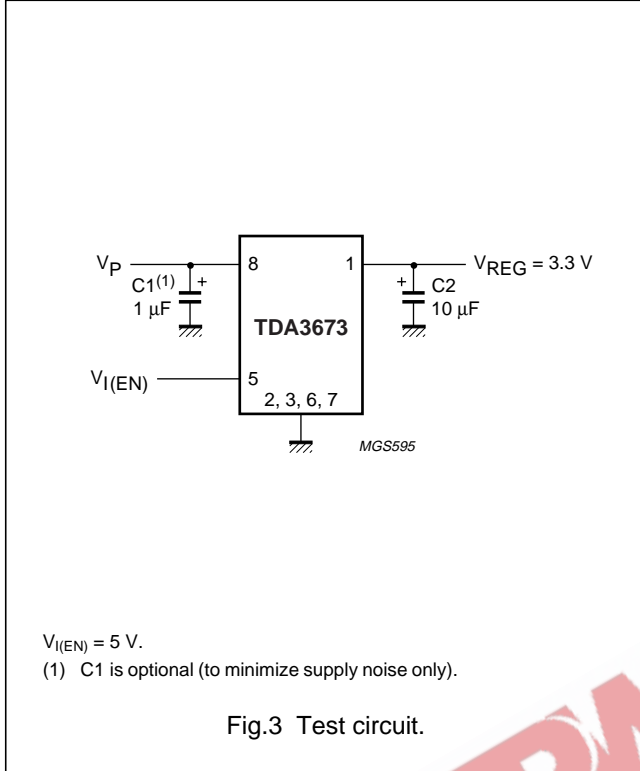

Noise

The output noise is determined by the value of the output capacitor. The noise figure is measured at a bandwidth of 10 Hz to 100 kHz (see Table 1).

Table 1 Noise figures

OUTPUT CURRENT I_{REG} (mA)	NOISE FIGURE (μV)		
	C2 = 10 μF	C2 = 47 μF	C2 = 100 μF
0.5	550	320	300
50	650	400	400

Stability

The regulator is stabilized with an external capacitor connected to the output. The value of this capacitor can be selected using the diagrams shown in Figs 4 and 5. The following four examples show the effects of the stabilization circuit using different values for the output capacitor.

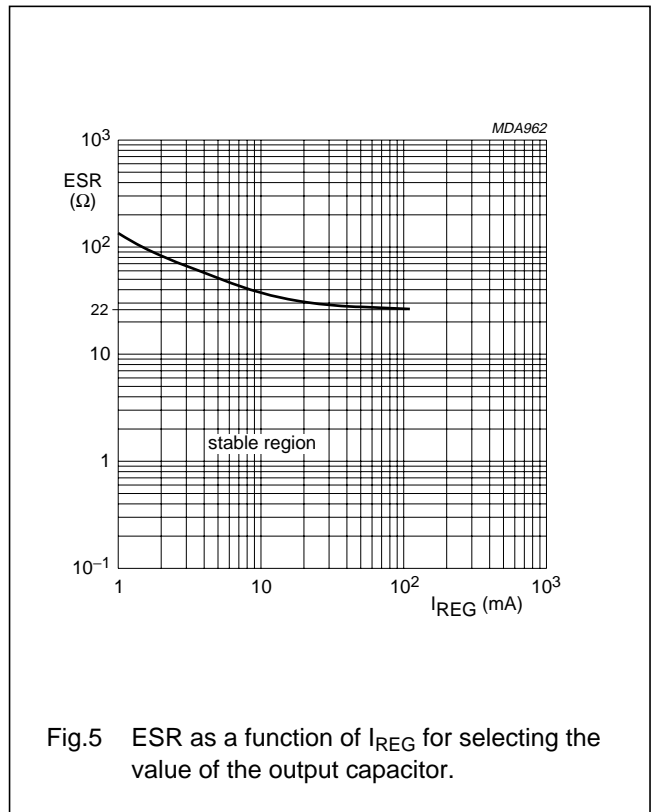

Very low dropout voltage/quiescent current 3.3 V voltage regulator with enable

TDA3673

EXAMPLE 1

The regulator is stabilized with an electrolytic capacitor of 68 μF (ESR = 0.5 Ω). At T_{amb} = -40 °C, the capacitor value is decreased to 22 μF and the ESR is increased to 3.5 Ω. The regulator will remain stable at a temperature of T_{amb} = -40 °C.

EXAMPLE 2

The regulator is stabilized with an electrolytic capacitor of 10 μF (ESR = 3.3 Ω). At T_{amb} = -40 °C, the capacitor value is decreased to 3 μF and the ESR is increased to 20 Ω. The regulator will remain stable at a temperature of T_{amb} = -40 °C.

EXAMPLE 3

The regulator is stabilized with a 100 nF MKT capacitor connected to the output. Full stability is guaranteed when the output current is larger than 200 μA. Because the thermal influence on this capacitor value is almost zero, the regulator will remain stable at a temperature of T_{amb} = -40 °C.

EXAMPLE 4

The regulator is stabilized with a 100 nF capacitor in parallel with a electrolytic capacitor of 10 μF connected to the output.

The regulator is now stable under all conditions and independent of:

- The ESR of the electrolytic capacitor
- The value of the electrolytic capacitor
- The output current.

Application circuits

The maximum output current of the regulator equals:

$$I_{REG(max)} = \frac{150 - T_{amb}}{R_{th(j-a)} \times (V_P - V_{REG})}$$

$$= \frac{150 - T_{amb}}{100 \times (V_P - 3.3)} \text{ (mA)}$$

When T_{amb} = 21 °C and V_P = 14 V, the maximum output current equals 116 mA.

For successful operation of the IC (maximum output current capability) special attention has to be given to the copper area required as heatsink (connected to all GND pins), the thermal capacity of the heatsink and its ability to transfer heat to the external environment. It is

possible to reduce the total thermal resistance from 120 to 50 K/W.

APPLICATION CIRCUIT WITH BACKUP FUNCTION

Sometimes a backup function is needed to supply, for example, a microcontroller for a short period of time when the supply voltage spikes to 0 V (or even -1 V).

This function can be easily built with the TDA3673 by using a large output capacitor. When the supply voltage is 0 V (or -1 V), only a small current will flow into pin REG from this large output capacitor (a few μA).

The application circuit is given in Fig.6.

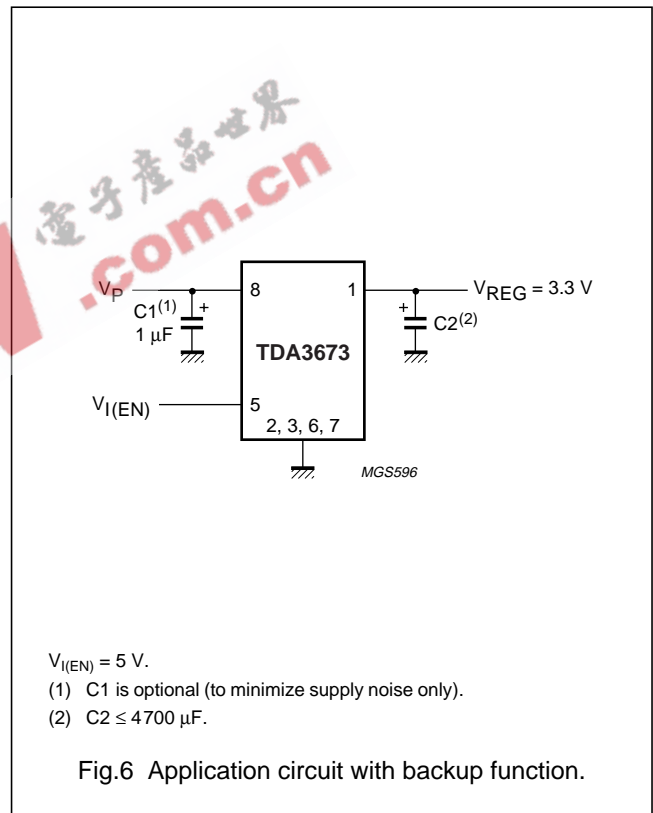

Very low dropout voltage/quiescent current 3.3 V voltage regulator with enable

TDA3673

Additional application information

This section gives typical curves for various parameters measured on the TDA3673AT. Standard test conditions are: $V_P = 14.4\text{ V}$; $T_{\text{amb}} = 25\text{ }^\circ\text{C}$.

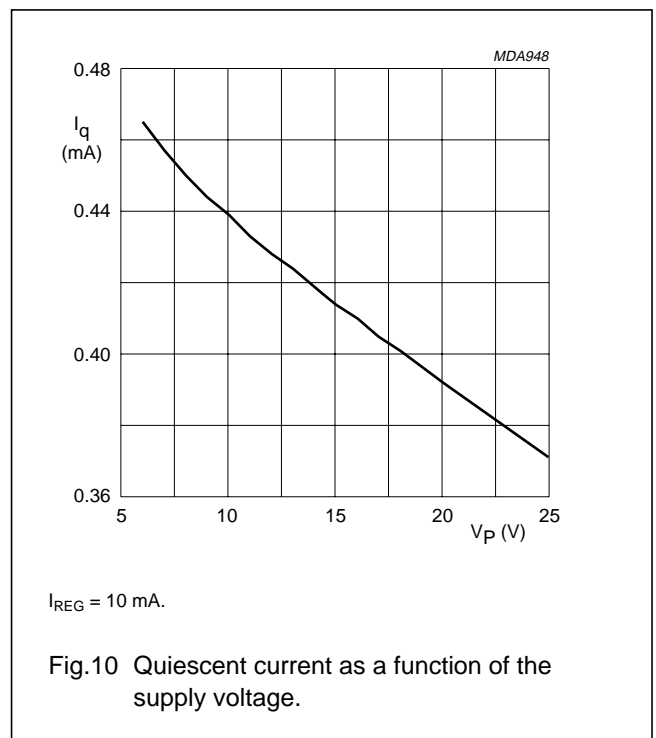
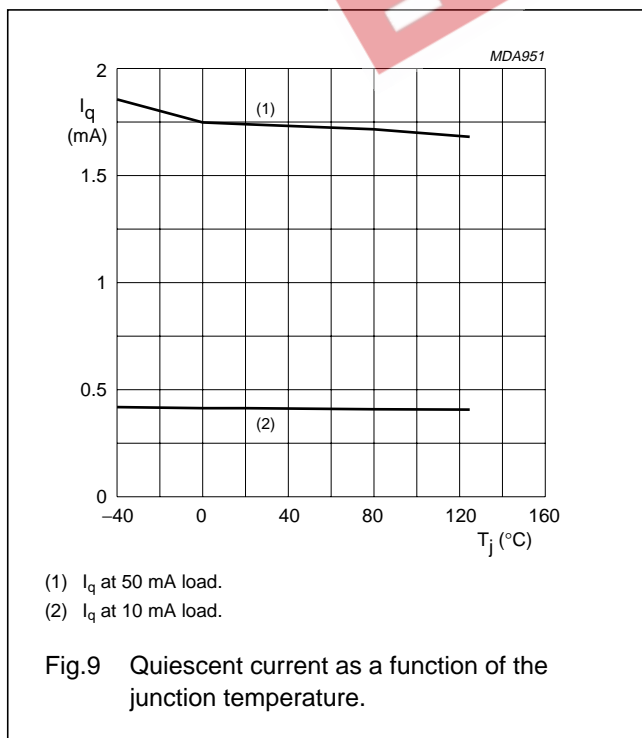
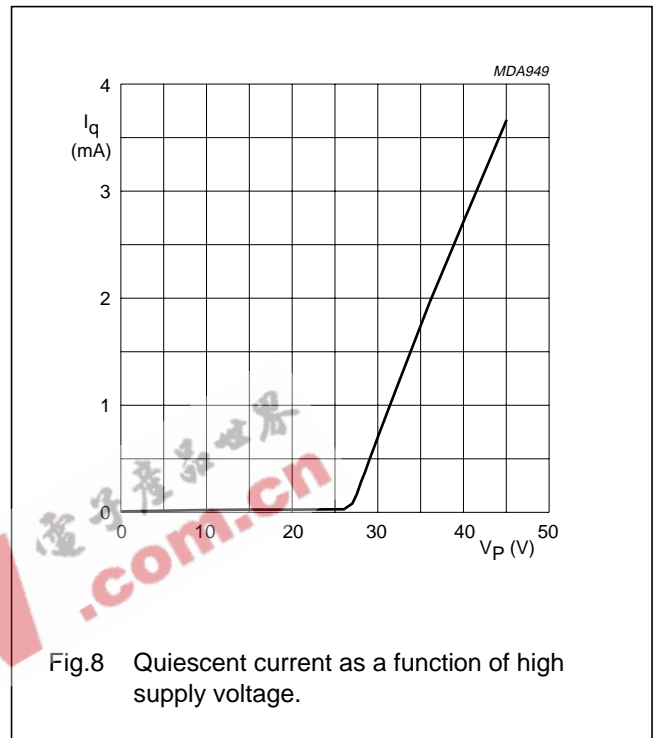
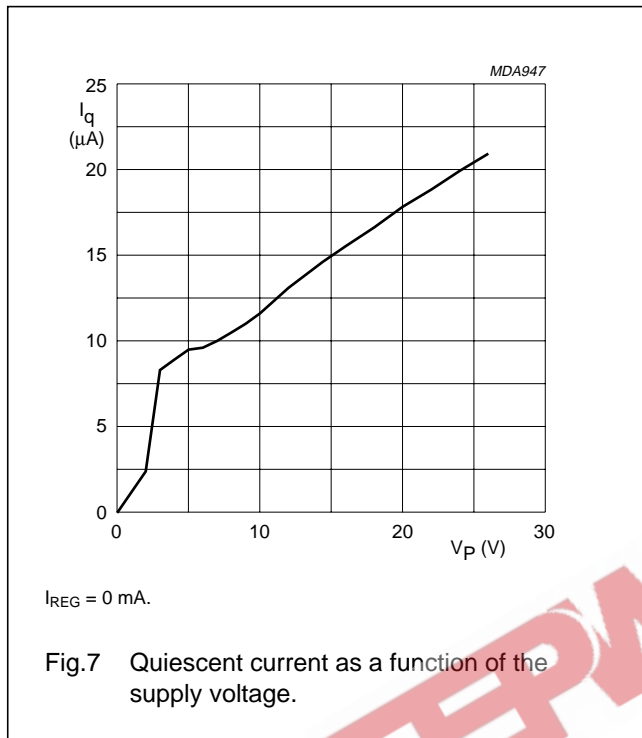

Very low dropout voltage/quiescent current
3.3 V voltage regulator with enable

TDA3673

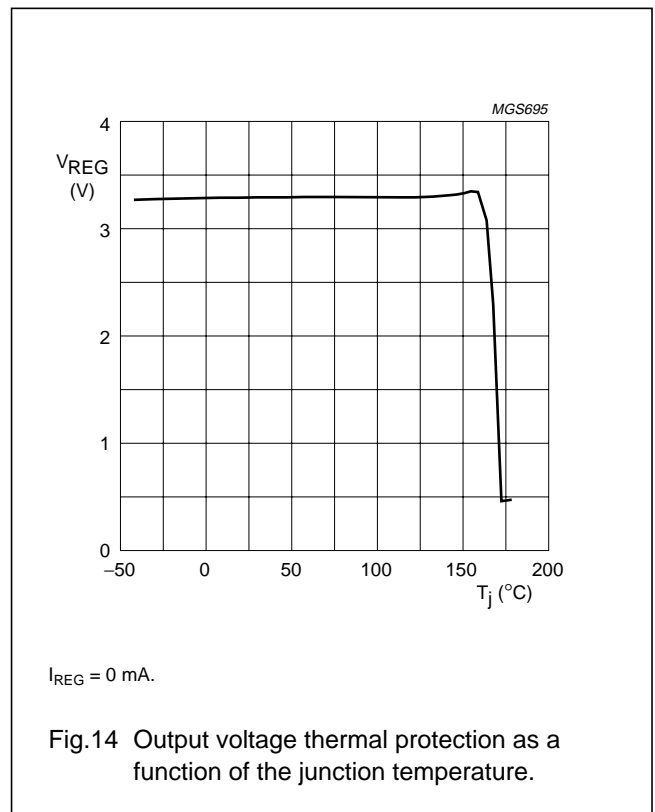
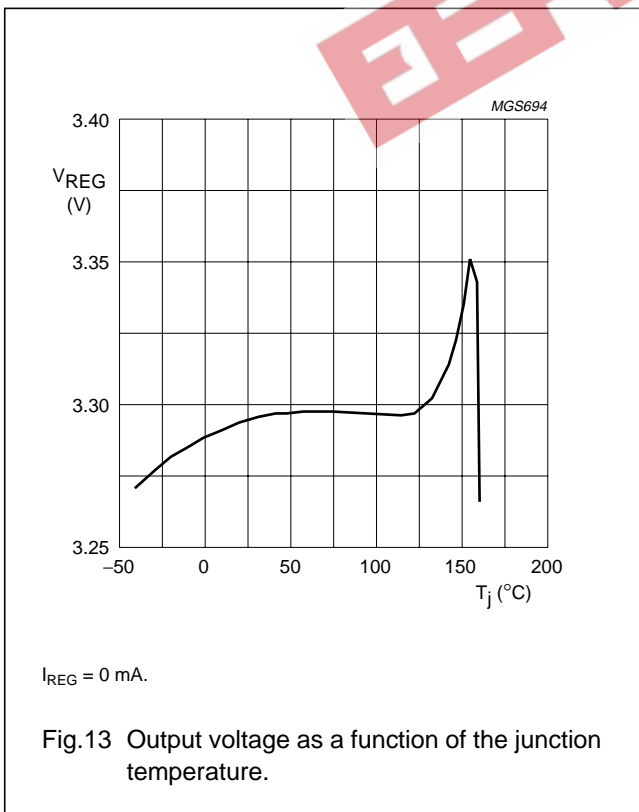
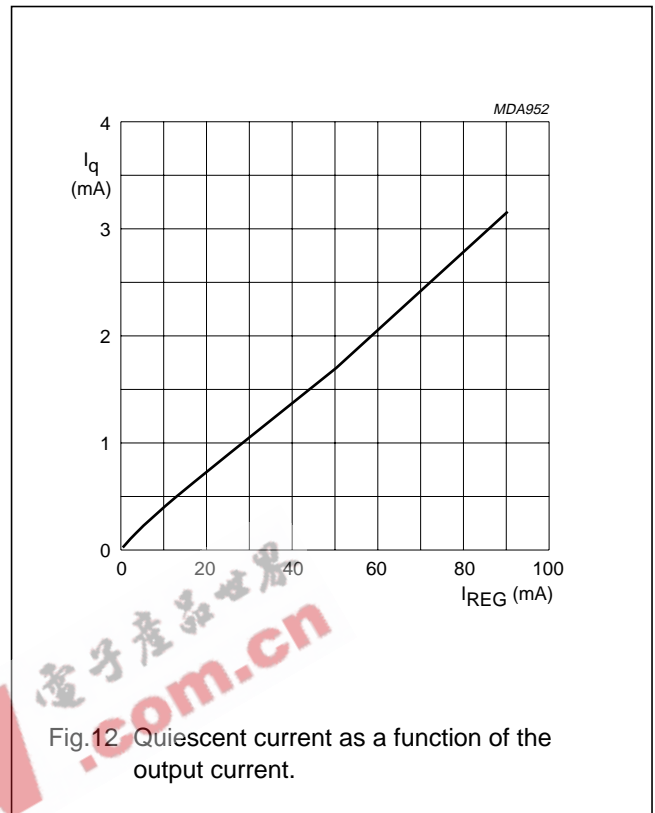
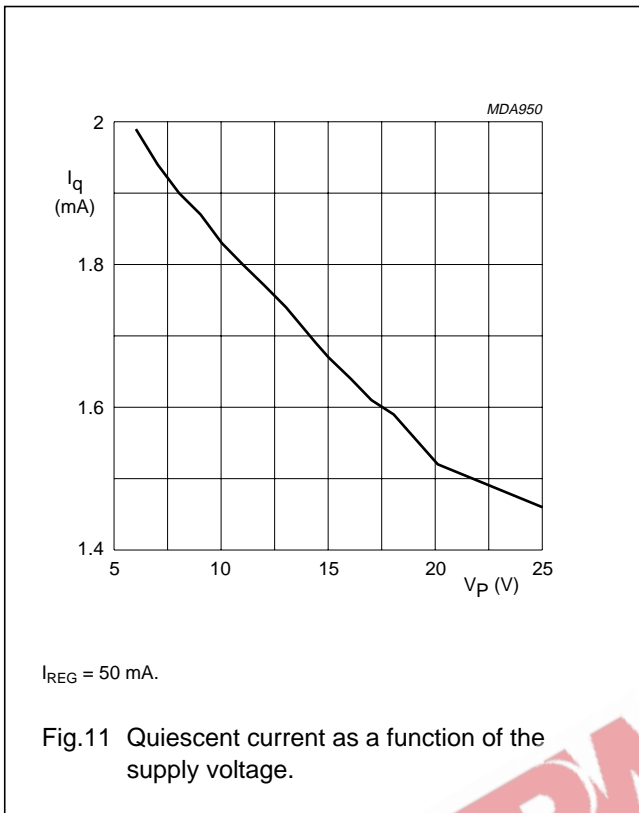

Very low dropout voltage/quiescent current
3.3 V voltage regulator with enable

TDA3673

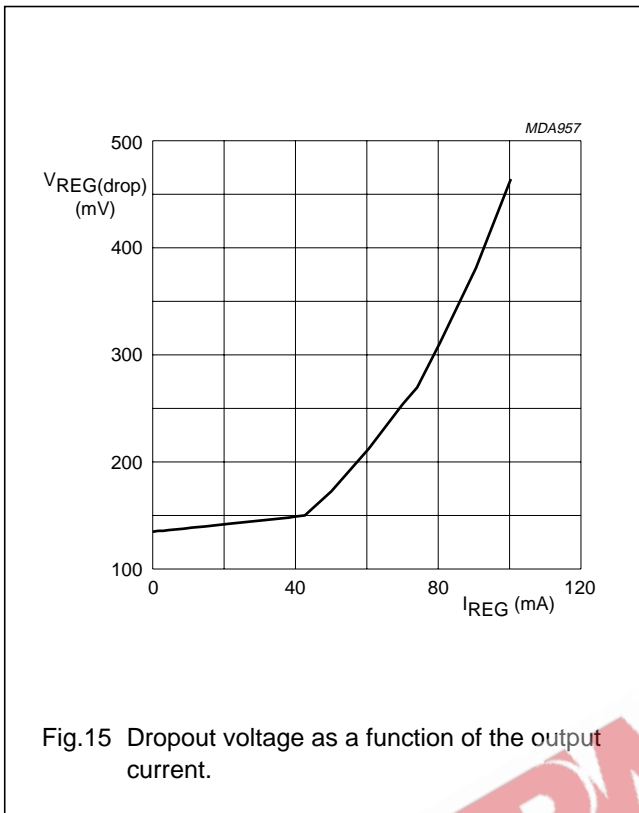
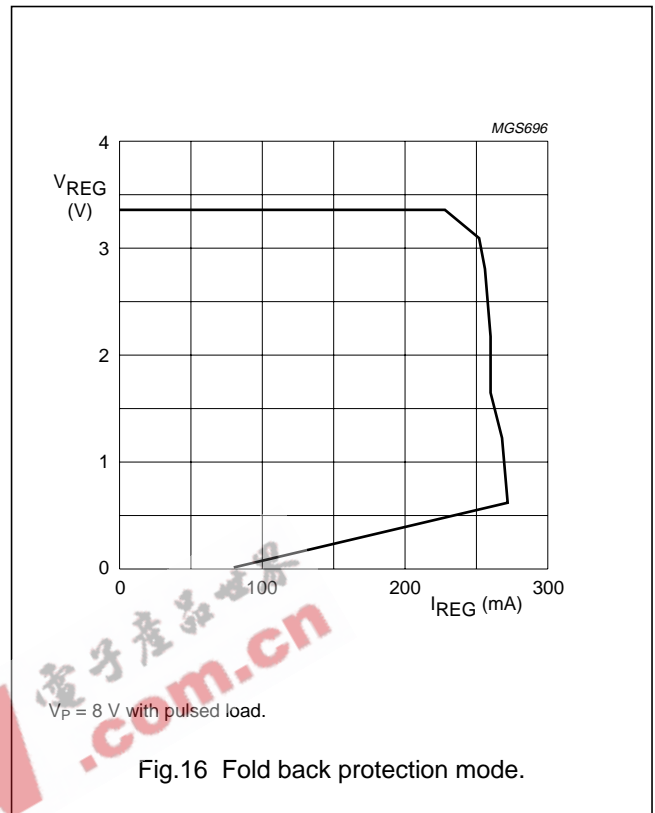
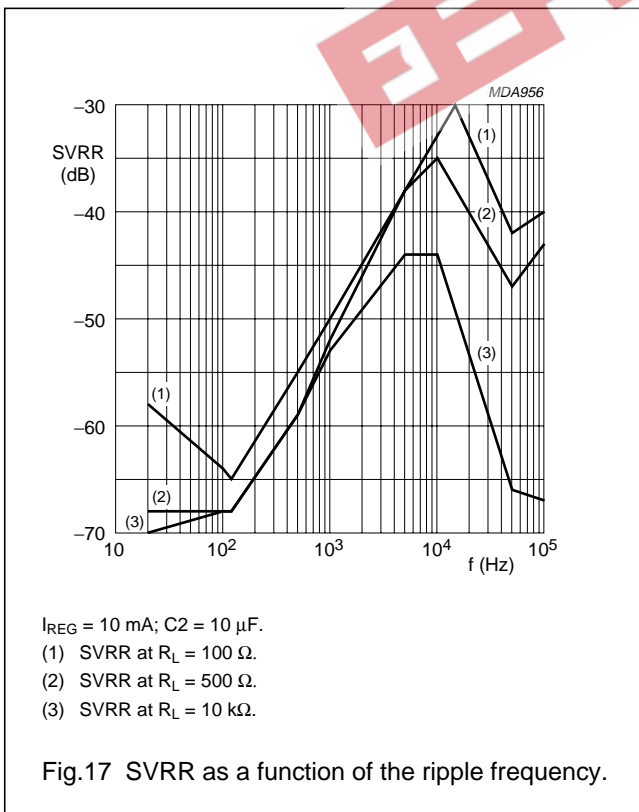

Fig.15 Dropout voltage as a function of the output current.



$V_P = 8\text{ V}$ with pulsed load.

Fig.16 Fold back protection mode.



$I_{REG} = 10\text{ mA}$; $C_2 = 10\ \mu\text{F}$.
 (1) SVRR at $R_L = 100\ \Omega$.
 (2) SVRR at $R_L = 500\ \Omega$.
 (3) SVRR at $R_L = 10\ \text{k}\Omega$.

Fig.17 SVRR as a function of the ripple frequency.

Very low dropout voltage/quiescent current
3.3 V voltage regulator with enable

TDA3673

PACKAGE OUTLINE

SO8: plastic small outline package; 8 leads; body width 3.9 mm

SOT96-1

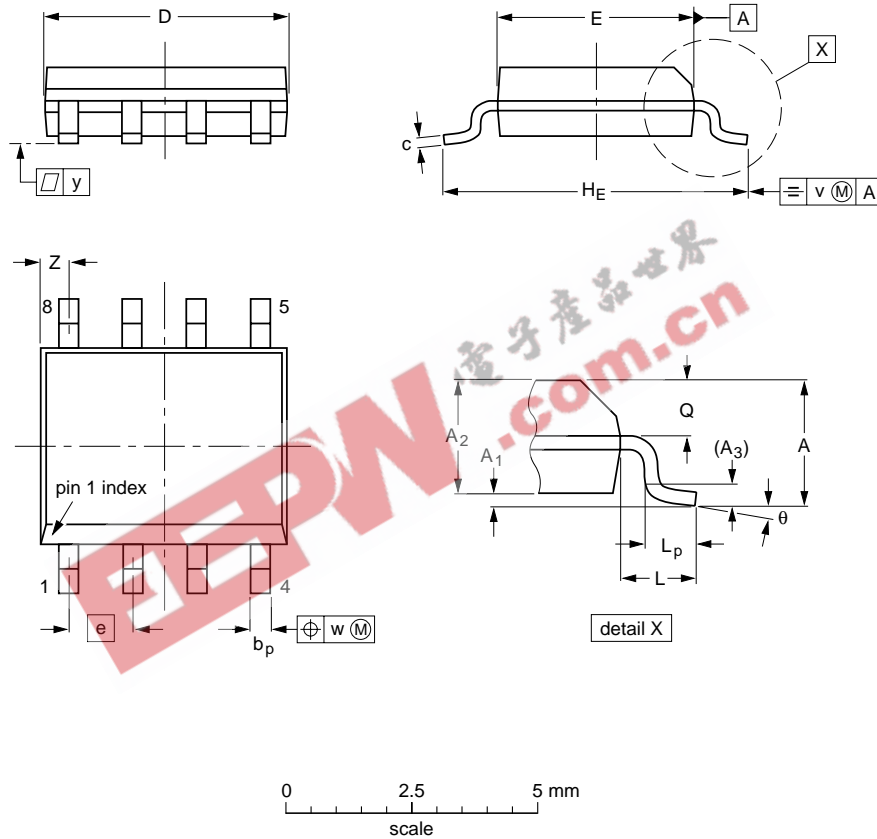

DIMENSIONS (inch dimensions are derived from the original mm dimensions)

UNIT	A max.	A ₁	A ₂	A ₃	b _p	c	D ⁽¹⁾	E ⁽²⁾	e	H _E	L	L _p	Q	v	w	y	z ⁽¹⁾	θ
mm	1.75	0.25 0.10	1.45 1.25	0.25	0.49 0.36	0.25 0.19	5.0 4.8	4.0 3.8	1.27	6.2 5.8	1.05	1.0 0.4	0.7 0.6	0.25	0.25	0.1	0.7 0.3	8° 0°
inches	0.069	0.010 0.004	0.057 0.049	0.01	0.019 0.014	0.0100 0.0075	0.20 0.19	0.16 0.15	0.050	0.244 0.228	0.041	0.039 0.016	0.028 0.024	0.01	0.01	0.004	0.028 0.012	

Notes

1. Plastic or metal protrusions of 0.15 mm maximum per side are not included.
2. Plastic or metal protrusions of 0.25 mm maximum per side are not included.

OUTLINE VERSION	REFERENCES			EUROPEAN PROJECTION	ISSUE DATE
	IEC	JEDEC	EIAJ		
SOT96-1	076E03	MS-012			97-05-22- 99-12-27

Very low dropout voltage/quiescent current 3.3 V voltage regulator with enable

TDA3673

SOLDERING

Introduction to soldering surface mount packages

This text gives a very brief insight to a complex technology. A more in-depth account of soldering ICs can be found in our "Data Handbook IC26; Integrated Circuit Packages" (document order number 9398 652 90011).

There is no soldering method that is ideal for all surface mount IC packages. Wave soldering is not always suitable for surface mount ICs, or for printed-circuit boards with high population densities. In these situations reflow soldering is often used.

Reflow soldering

Reflow soldering requires solder paste (a suspension of fine solder particles, flux and binding agent) to be applied to the printed-circuit board by screen printing, stencilling or pressure-syringe dispensing before package placement.

Several methods exist for reflowing; for example, infrared/convection heating in a conveyor type oven. Throughput times (preheating, soldering and cooling) vary between 100 and 200 seconds depending on heating method.

Typical reflow peak temperatures range from 215 to 250 °C. The top-surface temperature of the packages should preferably be kept below 230 °C.

Wave soldering

Conventional single wave soldering is not recommended for surface mount devices (SMDs) or printed-circuit boards with a high component density, as solder bridging and non-wetting can present major problems.

To overcome these problems the double-wave soldering method was specifically developed.

If wave soldering is used the following conditions must be observed for optimal results:

- Use a double-wave soldering method comprising a turbulent wave with high upward pressure followed by a smooth laminar wave.
- For packages with leads on two sides and a pitch (e):
 - larger than or equal to 1.27 mm, the footprint longitudinal axis is **preferred** to be parallel to the transport direction of the printed-circuit board;
 - smaller than 1.27 mm, the footprint longitudinal axis **must** be parallel to the transport direction of the printed-circuit board.

The footprint must incorporate solder thieves at the downstream end.

- For packages with leads on four sides, the footprint must be placed at a 45° angle to the transport direction of the printed-circuit board. The footprint must incorporate solder thieves downstream and at the side corners.

During placement and before soldering, the package must be fixed with a droplet of adhesive. The adhesive can be applied by screen printing, pin transfer or syringe dispensing. The package can be soldered after the adhesive is cured.

Typical dwell time is 4 seconds at 250 °C.

A mildly-activated flux will eliminate the need for removal of corrosive residues in most applications.

Manual soldering

Fix the component by first soldering two diagonally-opposite end leads. Use a low voltage (24 V or less) soldering iron applied to the flat part of the lead. Contact time must be limited to 10 seconds at up to 300 °C.

When using a dedicated tool, all other leads can be soldered in one operation within 2 to 5 seconds between 270 and 320 °C.

Very low dropout voltage/quiescent current 3.3 V voltage regulator with enable

TDA3673

Suitability of surface mount IC packages for wave and reflow soldering methods

PACKAGE	SOLDERING METHOD	
	WAVE	REFLOW ⁽¹⁾
BGA, SQFP	not suitable	suitable
HLQFP, HSQFP, HSOP, HTSSOP, SMS	not suitable ⁽²⁾	suitable
PLCC ⁽³⁾ , SO, SOJ	suitable	suitable
LQFP, QFP, TQFP	not recommended ⁽³⁾⁽⁴⁾	suitable
SSOP, TSSOP, VSO	not recommended ⁽⁵⁾	suitable

Notes

- All surface mount (SMD) packages are moisture sensitive. Depending upon the moisture content, the maximum temperature (with respect to time) and body size of the package, there is a risk that internal or external package cracks may occur due to vaporization of the moisture in them (the so called popcorn effect). For details, refer to the Drypack information in the "Data Handbook IC26; Integrated Circuit Packages; Section: Packing Methods".
- These packages are not suitable for wave soldering as a solder joint between the printed-circuit board and heatsink (at bottom version) can not be achieved, and as solder may stick to the heatsink (on top version).
- If wave soldering is considered, then the package must be placed at a 45° angle to the solder wave direction. The package footprint must incorporate solder thieves downstream and at the side corners.
- Wave soldering is only suitable for LQFP, TQFP and QFP packages with a pitch (e) equal to or larger than 0.8 mm; it is definitely not suitable for packages with a pitch (e) equal to or smaller than 0.65 mm.
- Wave soldering is only suitable for SSOP and TSSOP packages with a pitch (e) equal to or larger than 0.65 mm; it is definitely not suitable for packages with a pitch (e) equal to or smaller than 0.5 mm.

DEFINITIONS

Data sheet status	
Objective specification	This data sheet contains target or goal specifications for product development.
Preliminary specification	This data sheet contains preliminary data; supplementary data may be published later.
Product specification	This data sheet contains final product specifications.
Limiting values	
Limiting values given are in accordance with the Absolute Maximum Rating System (IEC 134). Stress above one or more of the limiting values may cause permanent damage to the device. These are stress ratings only and operation of the device at these or at any other conditions above those given in the Characteristics sections of the specification is not implied. Exposure to limiting values for extended periods may affect device reliability.	
Application information	
Where application information is given, it is advisory and does not form part of the specification.	

LIFE SUPPORT APPLICATIONS

These products are not designed for use in life support appliances, devices, or systems where malfunction of these products can reasonably be expected to result in personal injury. Philips customers using or selling these products for use in such applications do so at their own risk and agree to fully indemnify Philips for any damages resulting from such improper use or sale.

Very low dropout voltage/quiescent current
3.3 V voltage regulator with enable

TDA3673

NOTES



Very low dropout voltage/quiescent current
3.3 V voltage regulator with enable

TDA3673

NOTES



Philips Semiconductors – a worldwide company

Argentina: see South America

Australia: 3 Figtree Drive, HOMEBUSH, NSW 2140,
Tel. +61 2 9704 8141, Fax. +61 2 9704 8139

Austria: Computerstr. 6, A-1101 WIEN, P.O. Box 213,
Tel. +43 1 60 101 1248, Fax. +43 1 60 101 1210

Belarus: Hotel Minsk Business Center, Bld. 3, r. 1211, Volodarski Str. 6,
220050 MINSK, Tel. +375 172 20 0733, Fax. +375 172 20 0773

Belgium: see The Netherlands

Brazil: see South America

Bulgaria: Philips Bulgaria Ltd., Energoproject, 15th floor,
51 James Bourchier Blvd., 1407 SOFIA,
Tel. +359 2 68 9211, Fax. +359 2 68 9102

Canada: PHILIPS SEMICONDUCTORS/COMPONENTS,
Tel. +1 800 234 7381, Fax. +1 800 943 0087

China/Hong Kong: 501 Hong Kong Industrial Technology Centre,
72 Tat Chee Avenue, Kowloon Tong, HONG KONG,
Tel. +852 2319 7888, Fax. +852 2319 7700

Colombia: see South America

Czech Republic: see Austria

Denmark: Sydhavnsgade 23, 1780 COPENHAGEN V,
Tel. +45 33 29 3333, Fax. +45 33 29 3905

Finland: Sinikalliontie 3, FIN-02630 ESPOO,
Tel. +358 9 615 800, Fax. +358 9 6158 0920

France: 51 Rue Carnot, BP317, 92156 SURESNES Cedex,
Tel. +33 1 4099 6161, Fax. +33 1 4099 6427

Germany: Hammerbrookstraße 69, D-20097 HAMBURG,
Tel. +49 40 2353 60, Fax. +49 40 2353 6300

Hungary: see Austria

India: Philips INDIA Ltd, Band Box Building, 2nd floor,
254-D, Dr. Annie Besant Road, Worli, MUMBAI 400 025,
Tel. +91 22 493 8541, Fax. +91 22 493 0966

Indonesia: PT Philips Development Corporation, Semiconductors Division,
Gedung Philips, Jl. Buncit Raya Kav.99-100, JAKARTA 12510,
Tel. +62 21 794 0040 ext. 2501, Fax. +62 21 794 0080

Ireland: Newstead, Clonskeagh, DUBLIN 14,
Tel. +353 1 7640 000, Fax. +353 1 7640 200

Israel: RAPAC Electronics, 7 Kehilat Saloniki St, PO Box 18053,
TEL AVIV 61180, Tel. +972 3 645 0444, Fax. +972 3 649 1007

Italy: PHILIPS SEMICONDUCTORS, Via Casati, 23 - 20052 MONZA (MI),
Tel. +39 039 203 6838, Fax +39 039 203 6800

Japan: Philips Bldg 13-37, Kohnan 2-chome, Minato-ku,
TOKYO 108-8507, Tel. +81 3 3740 5130, Fax. +81 3 3740 5057

Korea: Philips House, 260-199 Itaewon-dong, Yongsan-ku, SEOUL,
Tel. +82 2 709 1412, Fax. +82 2 709 1415

Malaysia: No. 76 Jalan Universiti, 46200 PETALING JAYA, SELANGOR,
Tel. +60 3 750 5214, Fax. +60 3 757 4880

Mexico: 5900 Gateway East, Suite 200, EL PASO, TEXAS 79905,
Tel. +9-5 800 234 7381, Fax +9-5 800 943 0087

Middle East: see Italy

Netherlands: Postbus 90050, 5600 PB EINDHOVEN, Bldg. VB,
Tel. +31 40 27 82785, Fax. +31 40 27 88399

New Zealand: 2 Wagener Place, C.P.O. Box 1041, AUCKLAND,
Tel. +64 9 849 4160, Fax. +64 9 849 7811

Norway: Box 1, Manglerud 0612, OSLO,
Tel. +47 22 74 8000, Fax. +47 22 74 8341

Pakistan: see Singapore

Philippines: Philips Semiconductors Philippines Inc.,
106 Valero St. Salcedo Village, P.O. Box 2108 MCC, MAKATI,
Metro MANILA, Tel. +63 2 816 6380, Fax. +63 2 817 3474

Poland: Al.Jerozolimskie 195 B, 02-222 WARSAW,
Tel. +48 22 5710 000, Fax. +48 22 5710 001

Portugal: see Spain

Romania: see Italy

Russia: Philips Russia, Ul. Usatcheva 35A, 119048 MOSCOW,
Tel. +7 095 755 6918, Fax. +7 095 755 6919

Singapore: Lorong 1, Toa Payoh, SINGAPORE 319762,
Tel. +65 350 2538, Fax. +65 251 6500

Slovakia: see Austria

Slovenia: see Italy

South Africa: S.A. PHILIPS Pty Ltd., 195-215 Main Road Martindale,
2092 JOHANNESBURG, P.O. Box 58088 Newville 2114,
Tel. +27 11 471 5401, Fax. +27 11 471 5398

South America: Al. Vicente Pinzon, 173, 6th floor,
04547-130 SÃO PAULO, SP, Brazil,
Tel. +55 11 821 2333, Fax. +55 11 821 2382

Spain: Balmes 22, 08007 BARCELONA,
Tel. +34 93 301 6312, Fax. +34 93 301 4107

Sweden: Kottbygatan 7, Akalla, S-16485 STOCKHOLM,
Tel. +46 8 5985 2000, Fax. +46 8 5985 2745

Switzerland: Allmendstrasse 140, CH-8027 ZÜRICH,
Tel. +41 1 488 2741 Fax. +41 1 488 3263

Taiwan: Philips Semiconductors, 6F, No. 96, Chien Kuo N. Rd., Sec. 1,
TAIPEI, Taiwan Tel. +886 2 2134 2886, Fax. +886 2 2134 2874

Thailand: PHILIPS ELECTRONICS (THAILAND) Ltd.,
209/2 Sanpavuth-Bangna Road Prakanong, BANGKOK 10260,
Tel. +66 2 745 4090, Fax. +66 2 398 0793

Turkey: Yukari Dudullu, Org. San. Blg., 2.Cad. Nr. 28 81260 Umraniye,
ISTANBUL, Tel. +90 216 522 1500, Fax. +90 216 522 1813

Ukraine: PHILIPS UKRAINE, 4 Patrice Lumumba str., Building B, Floor 7,
252042 KIEV, Tel. +380 44 264 2776, Fax. +380 44 268 0461

United Kingdom: Philips Semiconductors Ltd., 276 Bath Road, Hayes,
MIDDLESEX UB3 5BX, Tel. +44 208 730 5000, Fax. +44 208 754 8421

United States: 811 East Arques Avenue, SUNNYVALE, CA 94088-3409,
Tel. +1 800 234 7381, Fax. +1 800 943 0087

Uruguay: see South America

Vietnam: see Singapore

Yugoslavia: PHILIPS, Trg N. Pasica 5/v, 11000 BEOGRAD,
Tel. +381 11 3341 299, Fax.+381 11 3342 553

For all other countries apply to: Philips Semiconductors,
International Marketing & Sales Communications, Building BE-p, P.O. Box 218,
5600 MD EINDHOVEN, The Netherlands, Fax. +31 40 27 24825

Internet: <http://www.semiconductors.philips.com>

© Philips Electronics N.V. 2000

SCA 69

All rights are reserved. Reproduction in whole or in part is prohibited without the prior written consent of the copyright owner.

The information presented in this document does not form part of any quotation or contract, is believed to be accurate and reliable and may be changed without notice. No liability will be accepted by the publisher for any consequence of its use. Publication thereof does not convey nor imply any license under patent- or other industrial or intellectual property rights.

Printed in The Netherlands

753503/02/pp16

Date of release: 2000 Feb 01

Document order number: 9397 750 06801

Let's make things better.

Philips
Semiconductors



PHILIPS