

**SURFACE MOUNTABLE  
 ULTRAFAST RECOVERY DIODE**

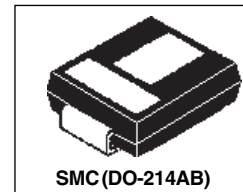

**Major Ratings and Characteristics**

Characteristics	30BF..			Units
	10 to 20	40	60 to 80	
$I_{F(AV)}$	3			A
$V_{RRM}$	100 to 800			V
$I_{FSM}$	100			A
$V_F @ 3A, T_J=25^\circ C$	1.0	1.4	1.7	V
$t_{rr} @ T_J=25^\circ C$	50	50	100	ns
$T_J$ range	-50 to 150			$^\circ C$

**Features**

- For surface mounted applications
- Low profile package
- Built in stress releaf
- Compatible with all pick & palce equipments
- Ultrafast recovery times for high efficiency
- Plastic package has Underwriters Laboratory Flammability Classification 94V-O
- Glass passivated junction
- High temperature soldering:  
260 $^\circ C$ \10 seconds at terminals

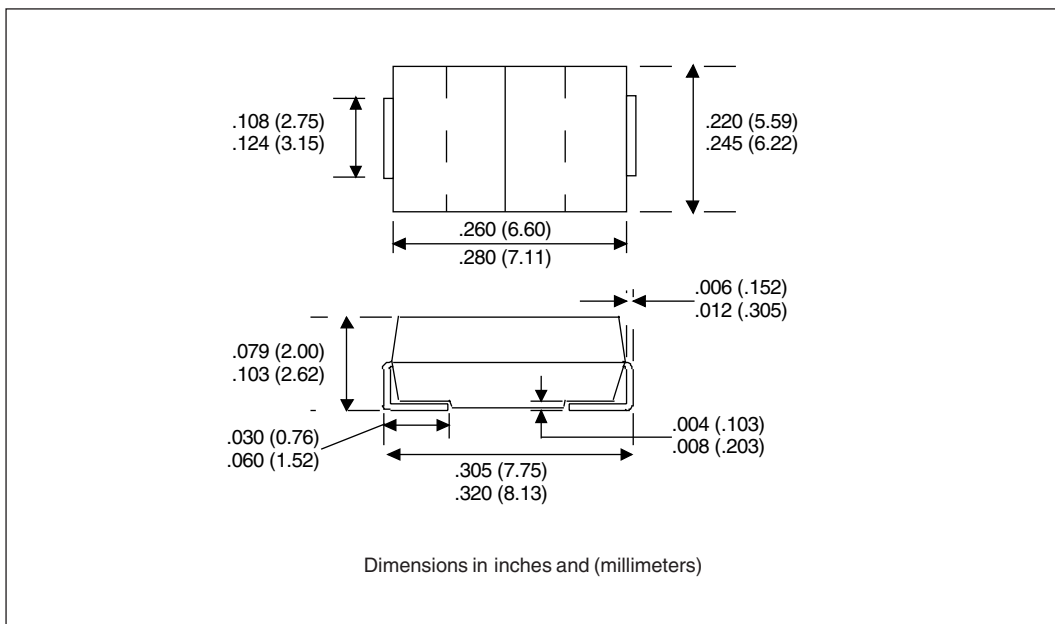

## 30BF.. Series

PD-20713 07/99

International  
 Rectifier

### Voltage Ratings

Part Number	$V_{RRM}$ , maximum peak reverse voltage V	$V_{DC}$ , maximum blocking voltage V	$I_{FRM}$ 100°C μA
30BF10	100	100	500
30BF20	200	200	
30BF40	400	400	
30BF60	600	600	
30BF80	800	800	

### Maximum Ratings and Electrical Characteristics

Parameters	30BF..			Units	Conditions
	10 to 20	40	60 to 80		
$I_{F(AV)}$ Maximum Average Forward Current	3			A	@ $T_L = 75^\circ\text{C}$
$I_{FSM}$ Peak Forward Surge Current	100			A	8.3ms single half sine wave superimposed on rated load (JEDEC Method) $T_A = 55^\circ\text{C}$
$V_{FM}$ Max. Instantaneous Forward Voltage	1.0	1.4	1.7	V	@ 3A
$I_{RM}$ Maximum DC Reverse Current at Rated DC Blocking Voltage	10			μA	$T_A = 25^\circ\text{C}$
	500				$T_A = 100^\circ\text{C}$
$t_{rr}$ Reverse Recovery Time	50	50	100	ns	$I_F = 0.5\text{A}, I_R = 1.0\text{A}, I_{rr} = 0.25\text{A}$
$C_J$ Typical Junction Capacitance	75	75	50	pf	@ 1.0MHz applied reverse voltage of 4.0V

Ratings at 25°C ambient temperature unless otherwise specified.

Resistive or inductive load.

For capacitive load, derate current by 20%.

### Mechanical Specifications

Parameters	30BF..	Units	Conditions
$R_{thJ}$ Maximum Thermal Resistance	15	°C/W	8.0mm <sup>2</sup> (.013mm thick) land areas
$T_J$ Operating Temperature Range	-50 to 150	°C	
$T_{stg}$ Storage Temperature Range	-50 to 150	°C	
wt Approximate Weight	0.21 (0.007)	g (oz)	
Case Style	DO-214AB		JEDEC molded plastic

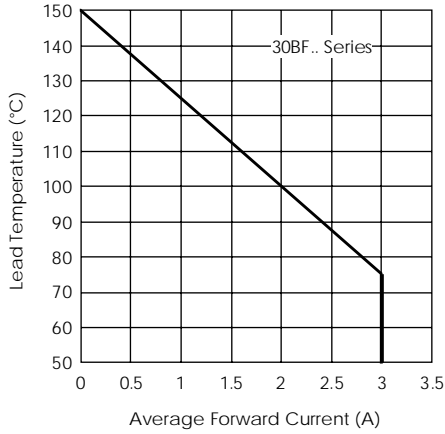

Fig. 1 - Maximum Average Forward Current Rating

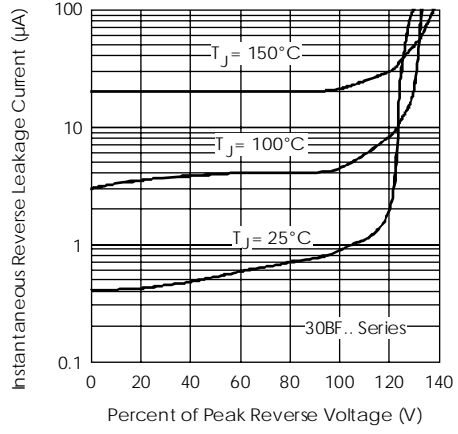

Fig. 2 - Typical Reverse Characteristics

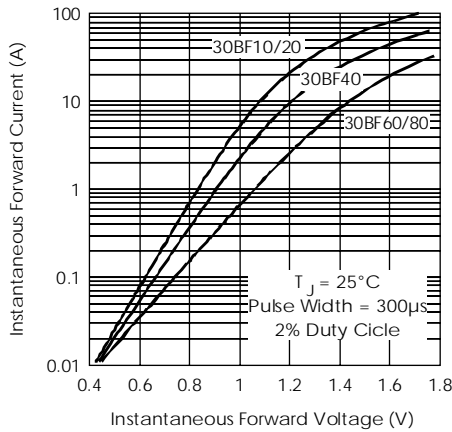

Fig. 3 - Typical Forward Characteristics

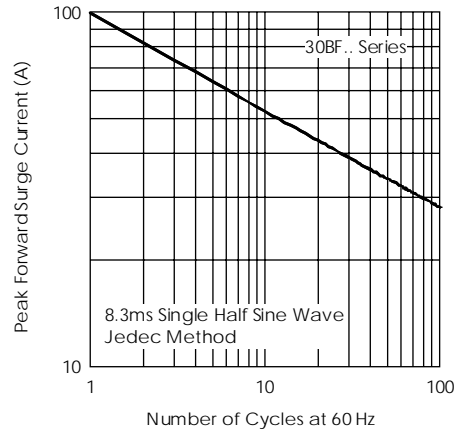

Fig. 4 - Max. Non-Repetitive Forward Surge Characteristic

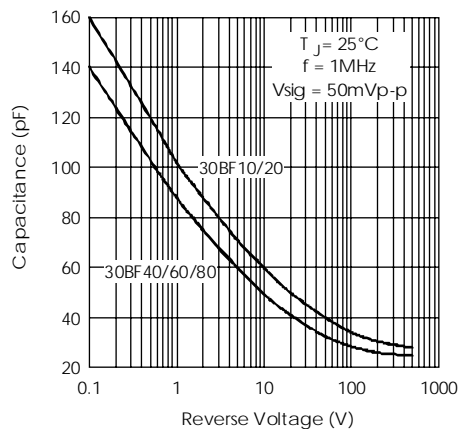
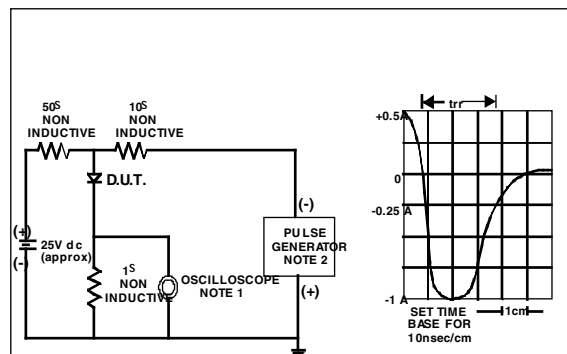

Fig. 5 - Typical Junction Capacitance



Reverse Recovery Time Characteristic and Test Circuit Diagram

Ordering Information Table

Device Code			
30	B	F	80
①	②	③	④

- 1** - Current Rating x 10: 30 = 3A
- 2** - B = DO-214AB (SMC) Surface Mount
- 3** - F = Ultrafast Recovery
- 4** - Voltage code: Code =  $V_{RRM} / 10$

Tape & Reel Information

The diagram illustrates the dimensions for the tape and reel. The top part shows a cross-section of the carrier tape with two components. The width of the carrier tape is 12mm. The distance between the two components is 8mm. An arrow labeled 'FEED DIRECTION' points to the right. The bottom part shows a top view of a 3-spoke reel with an outer diameter of  $\varnothing 330$  (13 inches). A side view of the reel shows a width of 12 (0.47 inches).

NOTE:  
 1. OUTLINE CONFORMS TO EIA-481.

Dimensions in millimeters and (inches)