

UltraFast Rectifier

Features

- Ultrafast Recovery Time
- Low Forward Voltage Drop
- Low Leakage Current
- 175°C Operating Junction Temperature
- Lead-Free ("PbF" suffix)

$$t_{rr} = 40\text{ns}$$

$$I_{F(AV)} = 30\text{Amp}$$

$$V_R = 300\text{V}$$

Description/ Applications

International Rectifier's 300V series are the state of the art Ultrafast recovery rectifiers designed with optimized performance of forward voltage drop and Ultrafast recovery time.

The planar structure and the platinum doped life time control guarantee the best overall performance, ruggedness and reliability characteristics.

These devices are intended for use in the output rectification stage of SMPS, UPS, DC-DC converters as well as freewheeling diodes in low voltage inverters and chopper motor drives.

Their extremely optimized stored charge and low recovery current minimize the switching losses and reduce over dissipation in the switching element and snubbers.

Absolute Maximum Ratings

Parameters	Max	Units
V_{RRM} Repetitive Peak Reverse Voltage	300	V
$I_{F(AV)}$ Average Rectified Forward Current @ $T_C = 142^\circ\text{C}$	Per Leg	15
	Total Device	30
I_{FSM} Non Repetitive Peak Surge Current @ $T_J = 25^\circ\text{C}$	Per Leg	140
T_J, T_{STG} Operating Junction and Storage Temperatures	- 65 to 175	$^\circ\text{C}$

Case Styles

30CPH03PbF

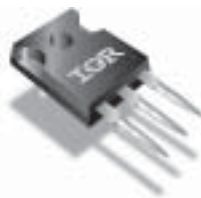

TO247

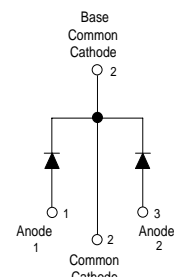

Electrical Characteristics @ $T_J = 25^\circ\text{C}$ (unless otherwise specified)

Parameters	Min	Typ	Max	Units	Test Conditions
V_{BR}, V_F Breakdown Voltage, Blocking Voltage	300	-	-	V	$I_R = 100\mu\text{A}$
V_F Forward Voltage	-	1.05	1.25	V	$I_F = 15\text{A}, T_J = 25^\circ\text{C}$
	-	0.85	1.00	V	$I_F = 15\text{A}, T_J = 125^\circ\text{C}$
I_R Reverse Leakage Current	-	0.05	40	μA	$V_R = V_R$ Rated
	-	12	400	μA	$T_J = 125^\circ\text{C}, V_R = V_R$ Rated
C_T Junction Capacitance	-	45	-	pF	$V_R = 300\text{V}$
L_S Series Inductance	-	8	-	nH	Measured lead to lead 5mm from package body

Dynamic Recovery Characteristics @ $T_J = 25^\circ\text{C}$ (unless otherwise specified)

Parameters	Min	Typ	Max	Units	Test Conditions
t_{rr} Reverse Recovery Time	-	-	40	ns	$I_F = 1.0\text{A}, di_F/dt = 50\text{A}/\mu\text{s}, V_R = 30\text{V}$
	-	32	-		$T_J = 25^\circ\text{C}$
	-	45	-		$T_J = 125^\circ\text{C}$
I_{RRM} Peak Recovery Current	-	2.4	-	A	$T_J = 25^\circ\text{C}$
	-	6.1	-		$T_J = 125^\circ\text{C}$
Q_{rr} Reverse Recovery Charge	-	38	-	nC	$T_J = 25^\circ\text{C}$
	-	137	-		$T_J = 125^\circ\text{C}$

$I_F = 15\text{A}$
 $di_F/dt = -200\text{A}/\mu\text{s}$
 $V_R = 200\text{V}$

Thermal - Mechanical Characteristics

Parameters	Min	Typ	Max	Units
T_J Max. Junction Temperature Range	- 65	-	175	°C
T_{Stg} Max. Storage Temperature Range	- 65	-	175	
R_{thJC} Thermal Resistance, Junction to Case Per Leg	-	0.9	2.0	°C/W
R_{thJA} ^① Thermal Resistance, Junction to Ambient Per Leg	-	-	40	
R_{thCS} ^② Thermal Resistance, Case to Heatsink	-	0.4	-	
Wt Weight	-	6.0	-	g
	-	0.21	-	(oz)
Mounting Torque	6.0	-	12	Kg-cm
	5.0	-	10	lbf.in
Marking Device	30CPH03			

① Typical Socket Mount

② Mounting Surface, Flat, Smooth and Greased

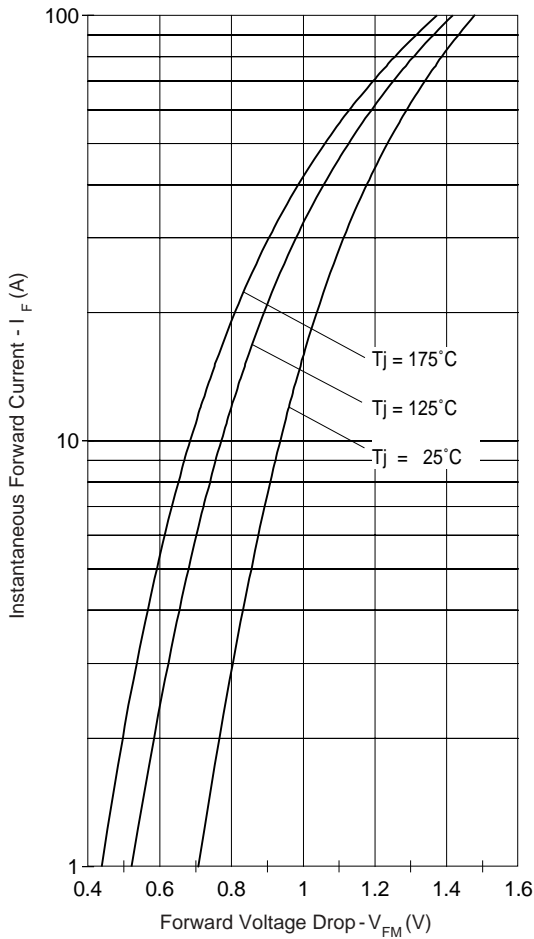

Fig. 1 - Typical Forward Voltage Drop Characteristics

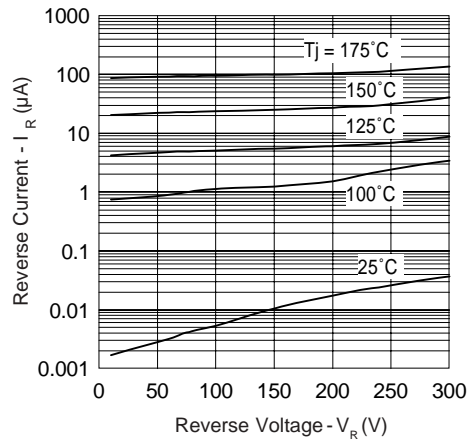

Fig. 2 - Typical Values Of Reverse Current Vs. Reverse Voltage

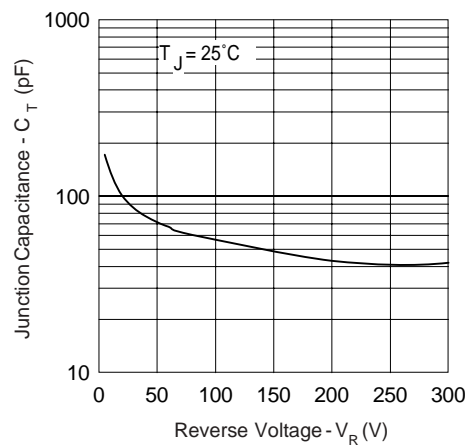

Fig. 3 - Typical Junction Capacitance Vs. Reverse Voltage

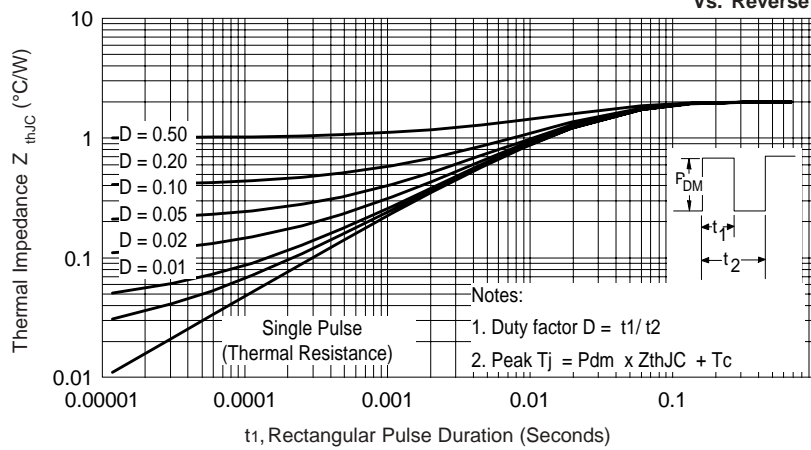

Fig. 4 - Max. Thermal Impedance Z_{thJC} Characteristics

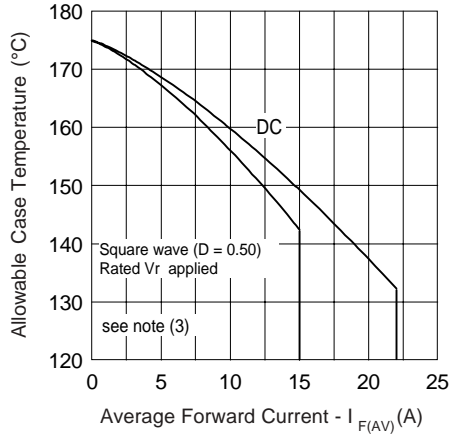

Fig. 5 - Max. Allowable Case Temperature Vs. Average Forward Current

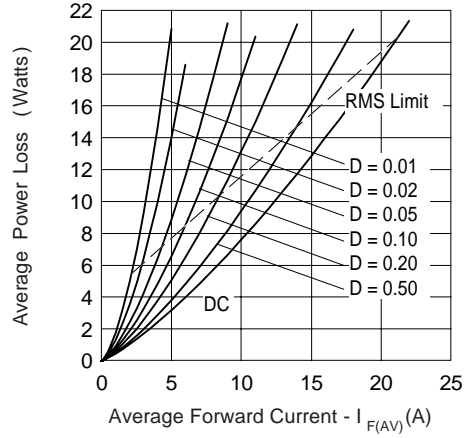

Fig. 6 - Forward Power Loss Characteristics

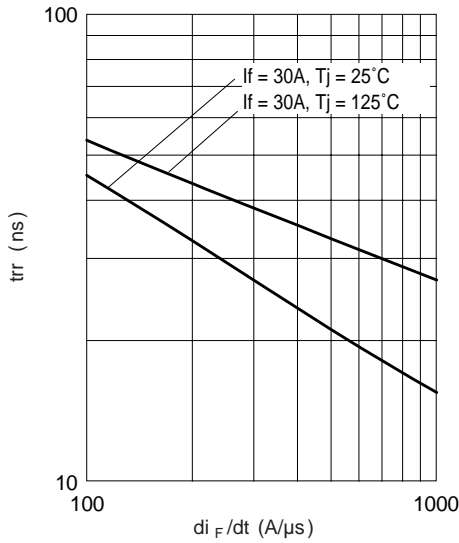

Fig. 7 - Typical Reverse Recovery vs. di_F/dt

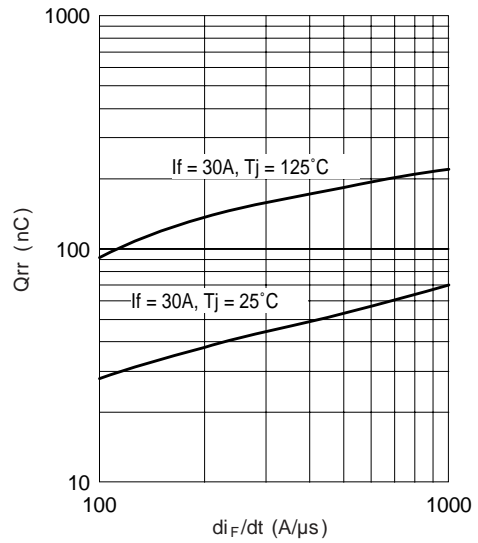

Fig. 8 - Typical Stored Charge vs. di_F/dt

(3) Formula used: $T_C = T_J - (Pd + Pd_{REV}) \times R_{thJC}$;
 $Pd = \text{Forward Power Loss} = I_{F(AV)} \times V_{FM} @ (I_{F(AV)}/D)$ (see Fig. 6);
 $Pd_{REV} = \text{Inverse Power Loss} = V_{R1} \times I_R (1-D); I_R @ V_{R1} = \text{rated } V_R$

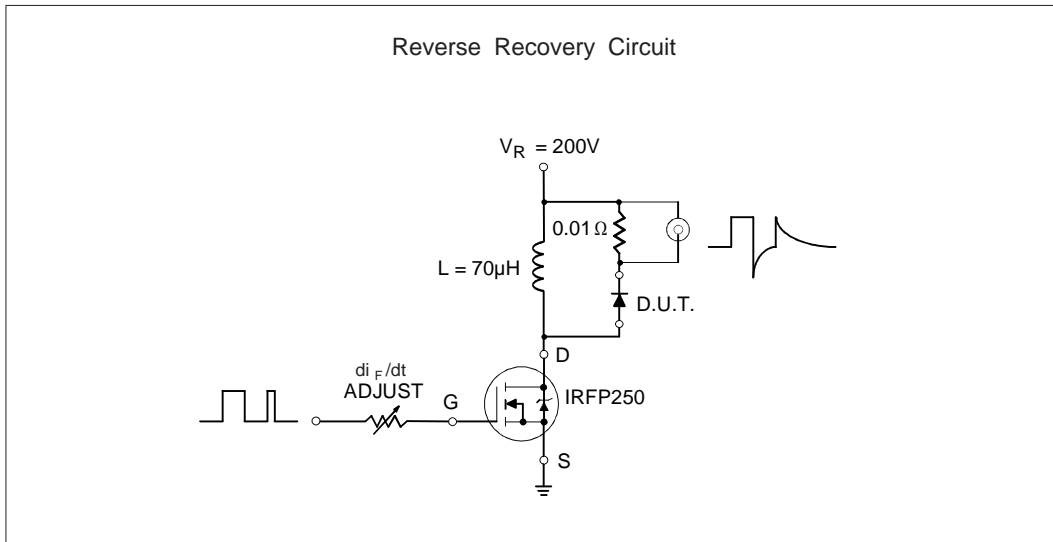

Fig. 9 - Reverse Recovery Parameter Test Circuit

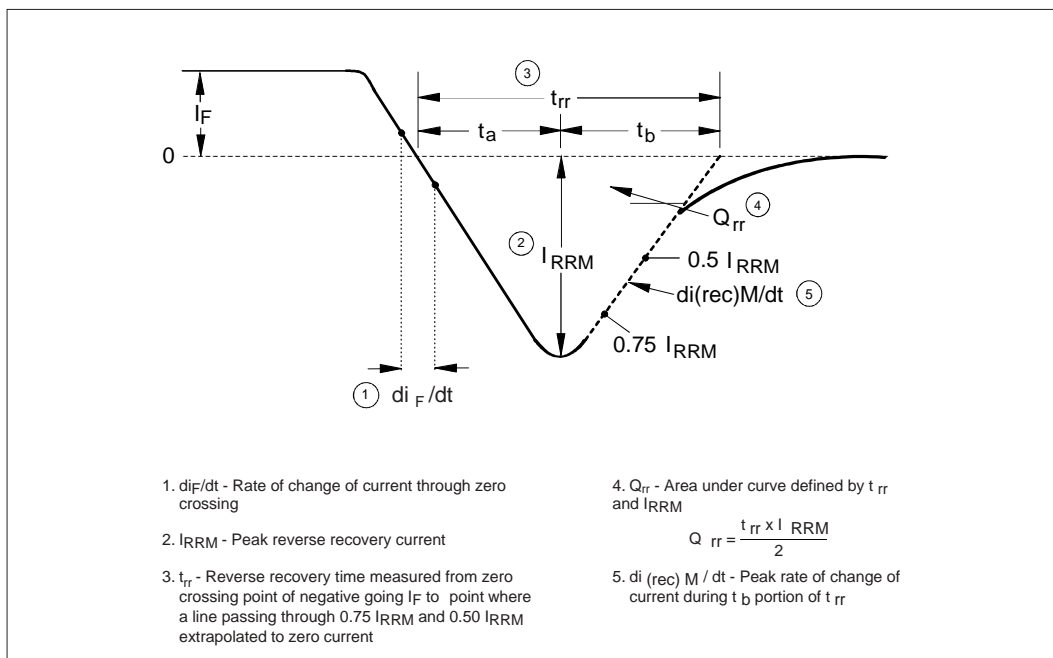
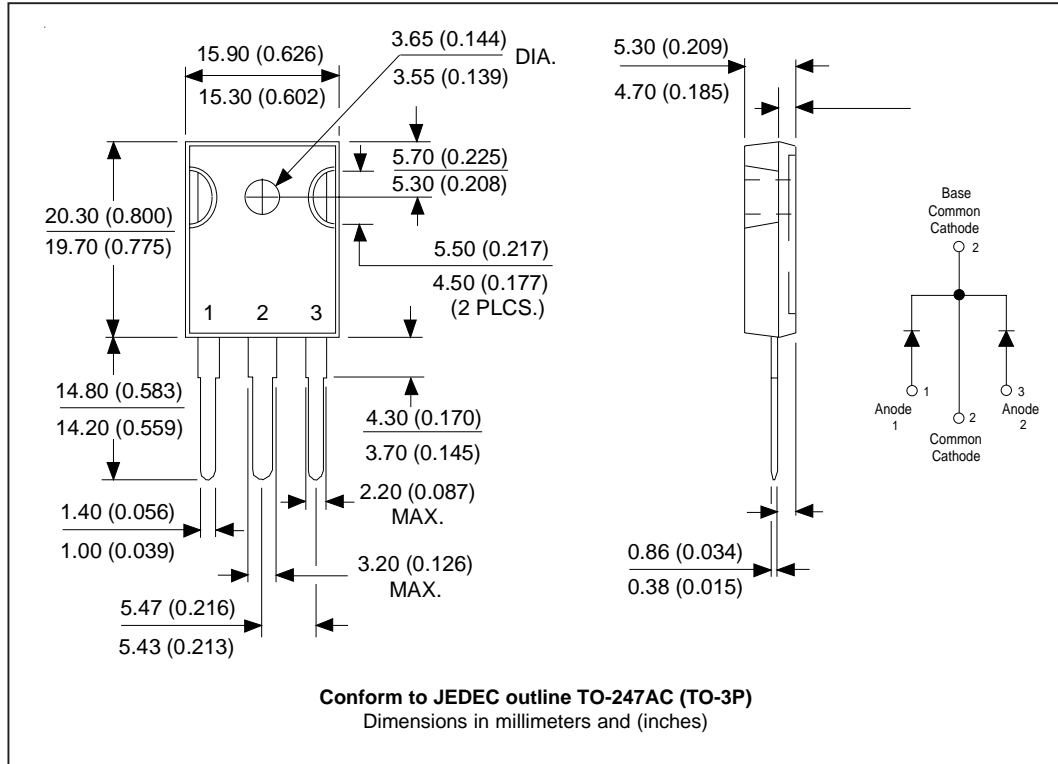
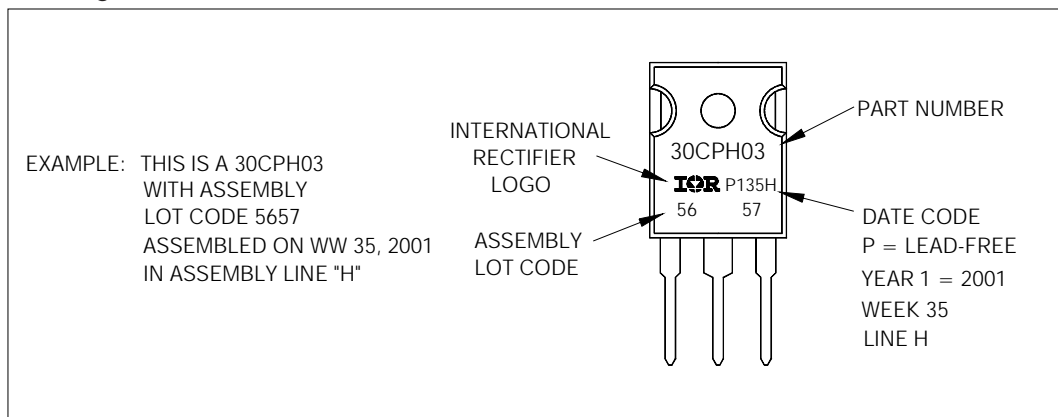

Fig. 10 - Reverse Recovery Waveform and Definitions

Outline Table



Marking Information



Ordering Information Table

Device Code													
	<table border="1" style="margin: auto;"> <tr> <td style="padding: 5px;">30</td> <td style="padding: 5px;">C</td> <td style="padding: 5px;">P</td> <td style="padding: 5px;">H</td> <td style="padding: 5px;">03</td> <td style="padding: 5px;">PbF</td> </tr> <tr> <td style="text-align: center;">①</td> <td style="text-align: center;">②</td> <td style="text-align: center;">③</td> <td style="text-align: center;">④</td> <td style="text-align: center;">⑤</td> <td style="text-align: center;">⑥</td> </tr> </table>	30	C	P	H	03	PbF	①	②	③	④	⑤	⑥
30	C	P	H	03	PbF								
①	②	③	④	⑤	⑥								
1	- Current Rating (30 = 30A)												
2	- Circuit Configuration C = Common Cathode												
3	- Package P = TO-247												
4	- Hyperfast Recovery												
5	- Voltage Rating (03 = 300V)												
6	- <ul style="list-style-type: none"> • none = Standard Production • PbF = Lead-Free 												
Tube Standard Pack Quantity : 25 pieces													

Data and specifications subject to change without notice.
 This product has been designed and qualified for Industrial Level and Lead-Free.
 Qualification Standards can be found on IR's Web site.